

HYGROMATIK®

WL-ROC-25/40/80/140

Reverse osmosis system



MANUAL



WLROC.EN
E-8881186

Certain computer programs contained in this product [or device] were developed by HygroMatik GmbH ("the Work(s)").

Copyright © HygroMatik GmbH [11.08.2021]

WL-ROC-25, WL-ROC-40, WL-ROC-80, WL-ROC-140 EN

All Rights reserved.

Current version of this manual to be found on: www.hygromatik.com

HygroMatik GmbH grants the legal user of this product [or device] the right to use the Work(s) solely within the scope of the legitimate operation of the product [or device]. No other right is granted under this licence. In particular and without prejudice to the generality of the foregoing, the Work(s) may not be used, sold, licensed, transferred, copied or reproduced in whole or in part or in any manner or form other than as expressly granted here without the prior written consent of HygroMatik GmbH.

Information in this manual is subject to change or alteration without prior notice.

⚠ WARNING

Risk of electrical shock!

Hazardous electrical voltage!

All electrical work to be performed by certified expert staff (electricians or expert personnel with equivalent training) only.

1. Introduction	6
1.1 Typographic Distinctions	6
1.2 Documentation	6
1.3 Symbols in Use	6
1.3.1 General Symbols	6
1.4 Intended Use	7
1.5 Unit sizes	7
2. Safety Instructions	8
2.1 Guidelines for Safe Operation	8
2.1.1 Scope	8
2.1.2 Unit control	8
2.1.3 Unit operation	8
2.1.4 Mounting, dismantling, maintenance and repair of the unit	9
2.1.5 Electrical	9
3. Transport	10
3.1 Overview	10
3.2 Interim Storage	10
3.3 Check for complete and correct delivery of goods	10
3.4 Scope of delivery	10
4. Function and structure	11
4.1 Mode of operation	11
4.2 Influencing factors	11
4.3 Operating conditions of the unit	12
4.4 Operating sequence	12
4.5 Mechanical construction	13
4.6 Flowchart	14
5. Mechanical installation	17
5.1 Environment Parameters to be met and Mounting Recommendations	17
5.2 Installation steps	18
5.2.1 Feed water connection	18
5.2.2 Permeate line connection	18
5.2.3 Connection of the expansion vessel	18
5.2.4 Connection of the concentrate line	19
5.2.5 Inserting the prefilter cartridge(s)	19
5.2.6 Inserting the membrane(s)	19
6. Water connection	21
7. Electrical connection	23
7.1 Procedure for electrical installation	23
7.2 Electrical installation check list	23
7.3 Inputs and outputs of the main board	24
8. Initial start-up and flushing of the membrane(s)	25
8.1 System start-up after initial commissioning	26
8.2 Adjusting the metering pump	27

9. Maintenance	28
9.1 General	28
9.2 Safety instructions for maintenance	28
9.3 Change prefilter	28
9.4 Membrane exchange	29
9.5 Maintenance scheme	29
9.5.1 Daily check	29
9.5.2 Weekly check	29
9.5.3 Maintenance every two months	30
9.5.4 Maintenance by qualified personnel	30
10. Decommissioning	31
10.1 Dismantling	31
10.2 Disposal after dismantling	31
11. Control	32
11.1 The control panel	32
11.2 Operating states	34
11.2.1 Alarm messages	35
11.3 Menu navigation	36
11.4 Setting options at operator level	37
11.5 Menu Structure	38
11.6 Setting options at service level	40
11.6.1 Conductivity sensors	40
11.6.2 Calibration of the probe zero point	41
11.6.3 Calibration of the probe slope	42
11.6.4 Permeate set point calibration	42
11.6.5 RAW/MIX set point calibration	43
11.6.6 Lower level switch LSLOW	44
11.6.7 Upper level switch LSHIGH	45
11.6.8 Calibration low pressure switch PSLOW	46
11.6.9 Calibration high pressure monitor (only WL-ROL/ WL-ROC140) PSHIGH	47
11.6.10 Upstream softening system INFIL	48
11.6.11 Module flushing	49
11.6.12 Configuration of the alarm - output relay	50
11.6.13 Operating and service hour counter	50
11.6.14 Function test relay outputs	51
11.6.15 Function test alarm output relay	51
11.6.16 Select language	52
11.6.17 Change password	52
11.6.18 Reset password	52
11.6.19 Setting the maintenance interval	53
11.6.20 Dosing pump antiscalant INPASC	53
11.6.21 Stand-by-Input INSB	54
11.6.22 Set start delay	54

11.7 Wiring diagram	55
12. Error description	57
13. Declaration of Conformity	59
14. Spare parts	61
15. Commissioning report / maintenance documentation	64
16. Technical specifications	66
16. Antiscalant	67

1. Introduction

Dear Customer,

Thank you for choosing a HygroMatik reverse osmosis unit. HygroMatik reverse osmoses units are state of the art.

In order to operate your HygroMatik reverse osmosis unit safely, properly and efficiently, please read these operating instructions.

Only use the HygroMatik R.O. unit in faultless condition and for its intended use, being aware of safety and hazards, and observing all instructions in this manual.

If you have additional questions, please contact your expert dealer.

For all technical questions or spare parts orders, please be prepared to provide unit type and serial number (see name plate on the unit).

1.1 Typographic Distinctions

- preceded by a bullet: general specifications

- » preceded by an arrow: Procedures for servicing or maintenance which should or must be performed in the indicated order

- ☑ Installation step which must be checked off.

- italics* Terms used with graphics or drawings

1.2 Documentation

Retention

Please retain these operating instructions in a secure, always accessible location. If the product is resold, turn the documentation over to the new operator. If the documentation is lost, please contact HygroMatik.

Versions in Other Languages

These operating instructions are available in several languages. If interested, please contact HygroMatik or your HygroMatik dealer.

1.3 Symbols in Use

Specific Symbols related to Safety Instructions

According to ANSI Z535.6 the following signal words are used within this document:

▲ DANGER

DANGER indicates a hazardous situation which, if not avoided, will result in death or serious injury.

▲ WARNING

WARNING indicates a hazardous situation which, if not avoided, could result in death or serious injury.

▲ CAUTION

CAUTION indicates a hazardous situation which, if not avoided, could result in minor or moderate injury.

NOTICE

NOTICE is used to address practices not related to physical injury.

1.3.1 General Symbols

Please note

This symbol is used whenever a situation requires special attention beyond the scope of safety instructions.

1.4 Intended Use

HygroMatik reverse osmosis unit used to produce fully demineralized water. It may only be used in accordance with its intended purpose.

NOTICE

- Intended use also includes compliance with the assembly, disassembly and reassembly, commissioning, operating and maintenance conditions and disposal measures prescribed by us.
- Only qualified and authorized personnel may work on and with the system. Persons who carry out transport or work on and with the system must have read the relevant parts of the operating instructions and in particular the chapter "Safety instructions". In addition, the personnel must be informed by the operator of any hazards that may exist. Leave a copy of the operating manual at the place of use of the unit.
- The installation of additional equipment is only permitted with the written approval of the manufacturer.

Use of the system

- The system is intended for operation (with use of feed water in the drinking water sector) of humidification systems.
- The limit and guide values of the German Drinking Water Ordinance must be taken into account.
- Frost protection and protection against excessive moisture must be ensured
- The permitted surrounding temperature is between 5° C and 40° C
- The use of a system separator according to DIN 1988, part 4 is obligatory.

NOTICE

- Avoid water temperatures above 20°C to prevent possible germ growth.
- Due to their construction, HygroMatik reverse osmosis systems are not intended for outdoor installation.

1.5 Unit sizes

The following reverse osmosis units belong to the WL-ROC (Reverse-Osmosis-Compact) series:

WL-ROC-25: max. permeate production rate of 25 l/h

WL-ROC-40: max. permeate production rate of 40 l/h

WL-ROC-80: max. permeate production rate of 80 l/h

WL-ROC-140: max. permeate production rate of 140 l/h

The following reverse osmosis plants belong to the WL-ROL (Reverse-Osmosis-Large) series

WL-ROL-160: max. permeate production rate of 160 l/h

WL-ROL-320: max. permeate production rate of 320 l/h

WL-ROL-460: max. permeate production rate of 460 l/h

WL-ROL-600: max. permeate production rate of 600 l/h

WL-ROL-1000: max. permeate production rate of 1000 l/h

WL-ROL-1200: max. permeate production rate of 1200 l/h

2. Safety Instructions

These safety instructions are required by law. They promote workplace safety and accident prevention.

2.1 Guidelines for Safe Operation

2.1.1 Scope

Comply with the accident prevention regulation „DGUV Regulation 3“ to prevent injury to yourself and others. Beyond that, national regulations apply without restrictions. This way you can protect yourself and others from harm.

2.1.2 Unit control

Do not perform any work which compromises the safety of the unit. Obey all safety instructions and warnings present on the unit.

In case of a malfunction or electrical power disruption, switch off the unit immediately and prevent a restart. Repair malfunctions promptly.

⚠ WARNING

Restricted use.

IEC 60335-1 stipulates as follows:

This device may be used by children of eight years of age and above as well as by persons with reduced physical, sensory or mental capabilities or lack of experience and knowledge so long as they are supervised or have been instructed regarding the safe use of the device and understand the hazards that may result from it. Cleaning and maintenance of the unit must not be undertaken by children without supervision.

NOTICE

The installation room must be adequately ventilated and be equipped with a floor drain. A water stop mechanism (e.g. leakage detector) can be used as an alternative.

2.1.3 Unit operation

⚠ CAUTION

Danger of scalding!

Hot surfaces can cause injuries. Protect yourself with suitable protective equipment.

NOTICE

Water leaks possible due to defective connections or malfunctions.

- Before starting work, the water supply to the reverse osmosis system (RO system) must be shut off.
- The system may be under pressure. Release pressure before starting work.
- The reverse osmosis (RO) systems continuously produce permeate (product water) and concentrate (waste water). Connections and water-carrying components must be checked regularly for correct functionality.

NOTICE

Risk of material damage!

- The unit may be damaged if switched on repeatedly following a malfunction without prior repair. Rectify defects immediately!
- Regularly check that all safety and monitoring devices are functioning normally. Do not remove or disable safety devices.

NOTICE

It is essential to leave the RO system connected to the power supply permanently. Only then the automatic rinsing can be carried out (protection against germs).

Switch device ON/OFF

The system can be switched on/off in different ways:

- » Interrupt the power supply (pull the plug) or
- » operate the main fuse switch (only WL-ROL units) or
- » press the ESC key (for about 2 seconds).

2.1.4 Mounting, dismantling, maintenance and repair of the unit

NOTICE

The HygroMatik reverse osmosis units are IP20 protected. Make sure that the unit is not object to dripping water in the mounting location.

NOTICE

Do not install HygroMatik reverse osmosis systems above electrical equipment such as fuse boxes, electrical appliances, etc. In the event of a leakage, leaking water can damage the underlying electrical systems.

NOTICE

- Use genuine spare parts only
- After any repair work, have qualified personnel check the safe operation of the unit
- Attaching or installing of **additional components** is permitted only with the **written consent** of the manufacturer

2.1.5 Electrical

⚠ WARNING

Risk of electrical shock!

Hazardous electrical voltage!

Any work on the electrical system to be performed by certified expert staff (electricians or expert personnel with comparable training) only.

During maintenance or installation work, the device must be disconnected from the power supply and secured against being switched on again. The absence of voltage must be ensured by a measurement.

After electrical installation or repair work, test all safety mechanisms (such as grounding resistance).

NOTICE

Use only original fuses with the appropriate amperage rating.

Regularly check the unit's electrical equipment. Promptly repair any damage such as loose connections or burned wiring.

Responsibility for intrinsically safe installation of the HygroMatik reverse osmosis unit is incumbent on the installing specialist company.

3. Transport

3.1 Overview

Please note

Proceed carefully when transporting the reverse osmosis unit in order to prevent damage due to stress or careless loading and unloading.

Protect the device from moisture during transport; the storage and shipping temperature is 5° to 40°C.

3.2 Interim Storage

Store the unit in a dry place and protect from frost and strong sunlight.

3.3 Check for complete and correct delivery of goods

Upon receipt of the unit, confirm that:

- model and serial number on the name plate match those specified in the order and delivery documents
- the equipment is complete and all parts are in perfect condition

Please note

In case of damage from shipment and/or missing parts, immediately notify the carrier or supplier in writing.

Time limits for filing freight claims with shipping companies are*:

Shipping company	After receipt of goods
Carriers	no later than 4 days
Parcel service	immediately

* Time limits for some services subject to change.

3.4 Scope of delivery

WL-ROC

- reverse osmosis unit incl. control
- 2 membranes (WL-ROC-25: only 1 membrane)
- 1 prefilter (WL-ROC-140: 2 prefilters)
- manual
- connection material
(the enclosed stainless steel adaptor (6 mm/ 10 mm JG) is only required for connection to a humiSonic ultrasonic humidifier)

WL-ROL

- Reverse osmosis unit incl. control
- 4 membranes (WL-ROL-160 and 320: only 2 membranes)
- 2 prefilters (5/10 µm)
- manual
- connection material
- Antiscalant canister (for device versions with integrated antiscalant pump)

Options:

- Retrofit antiscalant WL-ROC-140
- Retrofit kit blending WL-ROC-140
- Retrofit kit blending WL-ROC-25/-40/-80
- UV-lamp
- expansion vessel

4. Function and structure

4.1 Mode of operation

General principle of reverse osmosis

Osmosis is a natural process, it is understood as the one-sided diffusion of a liquid (here the feed water) through a semi-permeable membrane. A semi-permeable membrane is only permeable for certain substances..

As the liquid moves through a semi-permeable membrane, the pressure on the side with the lower concentration decreases and at the same time the pressure of the more concentrated solution increases until a balance is reached, stopping the water flow. Pressure difference between the two liquids is called "osmotic pressure".

Reverse osmosis, on the other hand, is a technical process in which the natural process is reversed. It involves applying a pressure higher than the osmotic pressure to the concentrated liquid so that the water flows in the opposite direction through the semi-permeable membrane and thus separates the salts solved in the water.

Using this principle, water can be demineralized for drinking water as well as for process and industrial applications.

4.2 Influencing factors

The performance of the reverse osmosis membrane depends strongly on the following parameters:

Water inlet pressure at the membrane:

By lowering the working pressure, a reduction in permeate production can be achieved.

By increasing the working pressure, an increase in permeate production is also achieved.

The pump pressure can be changed by turning the screw on the pump (see chapter 8.4).

Be careful not to exceed the maximum pump pressure!

Salt content of the feed water:

The higher the salt content, the faster the membrane wear.

Temperature of the feed water:

The WL-ROC unit is set up for a feed water temperature of 15°C. Any difference from this temperature will affect the production quantity and the quality of the permeate.

The following table shows the variation of the permeate production quantity by 3% per differing 1°C.

Temperature	15 °C	+ 1	+ 2	+ 3	+ 4	+ 5	+ 6	+ 7	+ 8
Correction factor	1	1,03	1,06	1,09	1,12	1,15	1,18	1,21	1,25

Temperature	15 °C	- 1	- 2	- 3	- 4	- 5	- 6	- 7	- 8
Correction factor	1	0,96	0,92	0,88	0,84	0,8	0,77	0,74	0,7

The colder the feed water, the lower the permeate production and the better/lower the conductivity.

The warmer the feed water, the higher the production quantity, but the lower the permeate quality.

4.3 Operating conditions of the unit

The WL-ROC system can be fed with water from the normal water supply if the water has a maximum hardness up to 20°dH.

In order to avoid a reduction of the operating capacity, the water to be treated must comply with certain parameters:

turbidity	< 1 NTU
Iron	< 0,15 ppm
Manganese	< 0,05 ppm
Aluminium	< 0,05 ppm
SDI (Silt Density Index)	< 3
Water temperature	5 to 25 °C
Free chlorine	< 0.25 ppm
Hardness	< 20 °dH(30 °F)
Oil and fat	< 0.1 mg/l
COD	< 10 mg/l
TOC	< 3 mg/l
TDS	< 1000µS/cm
SiO ₂	< 15 ppm
SO ₄	< 75 ppm

In some cases the reverse osmosis unit cannot be fed with water from the normal water supply because some elements contained in the water (free chlorine, iron, suspended solids, hardness minerals) would disturb the osmotic process and damage the membranes, sometimes irreversibly.

In these cases a pre-treatment is necessary, e.g: De-ironing, de-chlorination, softening with resins or chemical softening (dosing pump with anti-fogging agent), depending on the characteristics of the water to be treated.

4.4 Operating sequence

The feed water (raw water) is pumped through the pre-filter, which guarantees the de-chlorination and a final filter capacity of 5 µm. This ensures the necessary clarity of the water at the membrane inlet. The feed water pressure must be at least 2 to 5 bar during normal operation to ensure a correct supply pressure at the pump inlet.

The water then flows through the water inlet solenoid valve SV1 and is then directed by the pressure pump at high pressure to the membrane(s).

The pressure switch PS_{HIGH} provides a signal when the pressure exceeds 10 bar at the membrane inlet (WL-ROC140 only).

Pure water (permeate) passes through the membrane; the salts solved in the water are retained by the membrane and drained off (concentrate).

The permeate now flows via the pure water line (scope of delivery) to the expansion vessel or the permeate collecting tank.

The quality of the permeate leaving the system is controlled by the conductivity sensor (EC_{PROBout}).

The production process stops automatically when the water outlet pressure has reached 4 bar at the pressure switch PS_{MAX}. The pressure in the following circuit is kept constant by the expansion vessel.

If the pressure in the following circuit at the pressure switch PS_{MIN} falls below 2 bar (when the expansion vessel is empty), the unit starts permeate production again.

If the inlet pressure falls below 0.8 bar, the pressure switch PS_{LOW} gives the corresponding alarm and interrupts operation.

NOTICE

The reverse osmosis (R.O.) units of the WL - ROC series should not operate without an expansion vessel or permeate collecting tank.

4.5 Mechanical construction

WL-ROC- 25 to -80

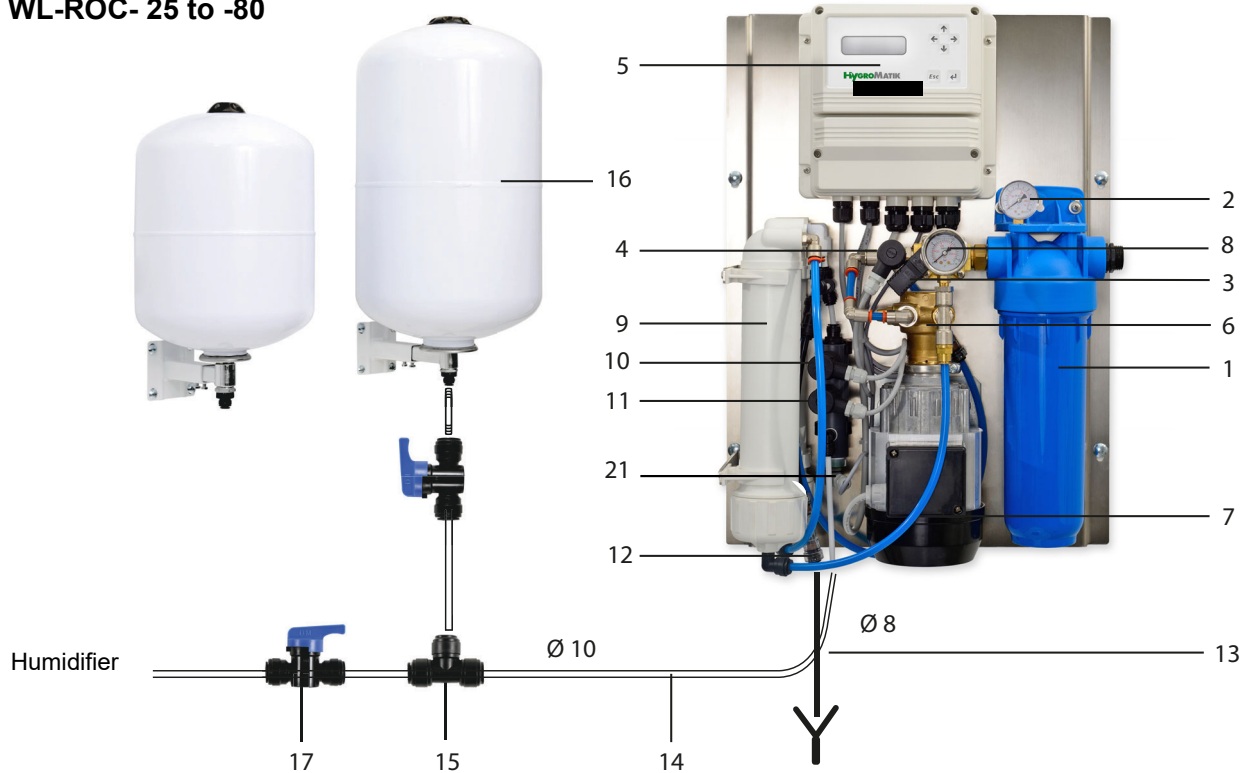

1	Prefilter/ CB-EC activated carbon filter*
2	Pressure gauge (feed water) / PI
3	Water inlet solenoid valve
4	Pressure switch PS HIGH
5	control
6	Rotary vane pump 150 l/h
7	Engine

8	Pressure gauge (permeate) / PI
9	Membrane pressure pipe
10	Pressure switch / PS MIN
11	Pressure switch / PS MAX
12	Flow limiter concentrate
13	Concentrate pipe
14	Permeate pipe

15	T-piece connection expansion vessel
16	Expansion vessel
17	Manual control valve / RV
18	Flush valve (solenoid valve)
19	Pressure switch / PS LOW
20	Prefilter/ CB-EC activated carbon filter*
21	Conductivity sensor

WL-ROC-140

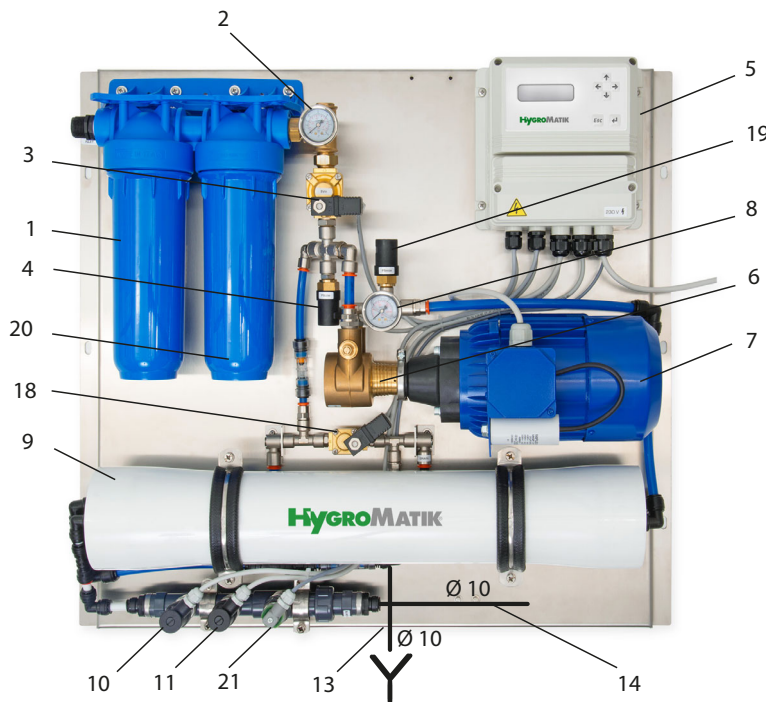

- * activated carbon filter
- WL-ROC-25 - 80: 5µ
 - WL-ROC-140: 10µ

- ** sediment filter
- only WL-ROC-140

The devices of the Hygro-Matik WL-ROC series are designed for wall mounting.

4.6 Flowchart

ROC 25

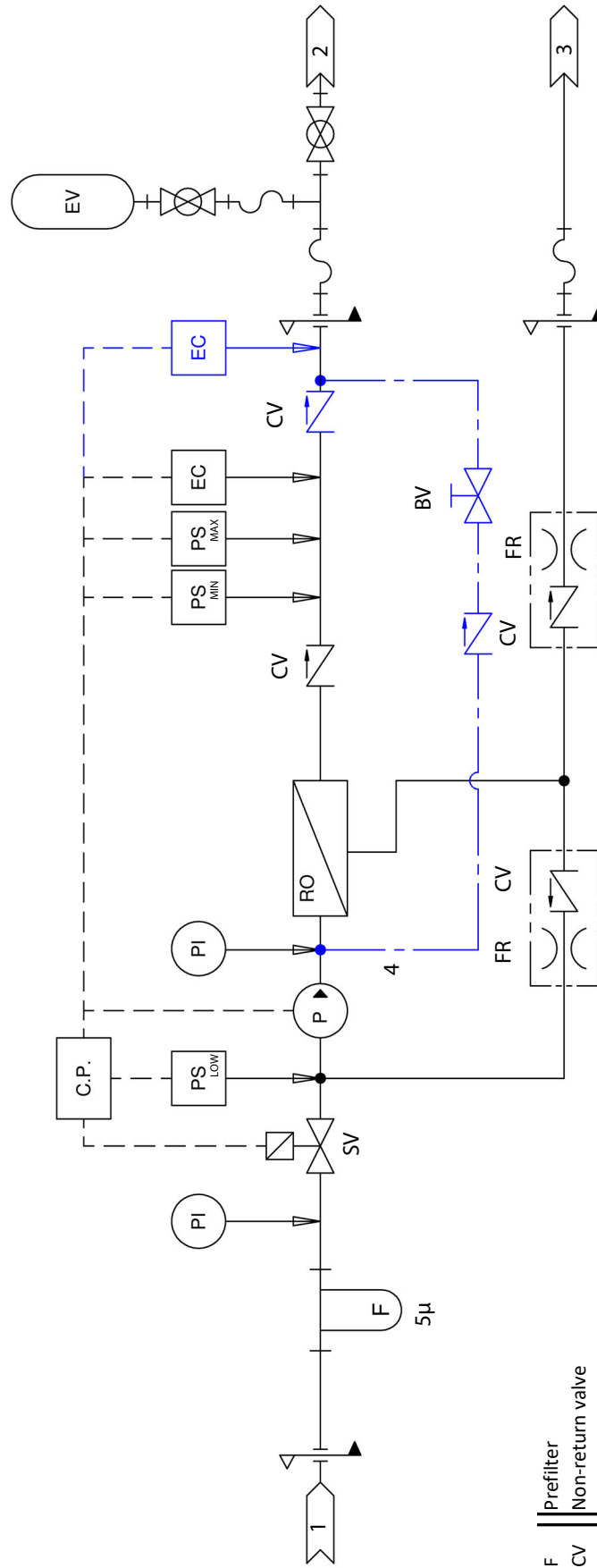

F	Prefilter
CV	Non-return valve
PS	Pressure switch
BV	Manual ball valve
C.P.	Control
FR	Flow limiter
SV	Solenoid valve
PI	Pressure gauge
EV	Expansion vessel
RV	Manual control valve
EC	Conductivity sensor
1	Feed water
2	Permeate
3	Concentrate
4	Blending kit

ROC 40-80

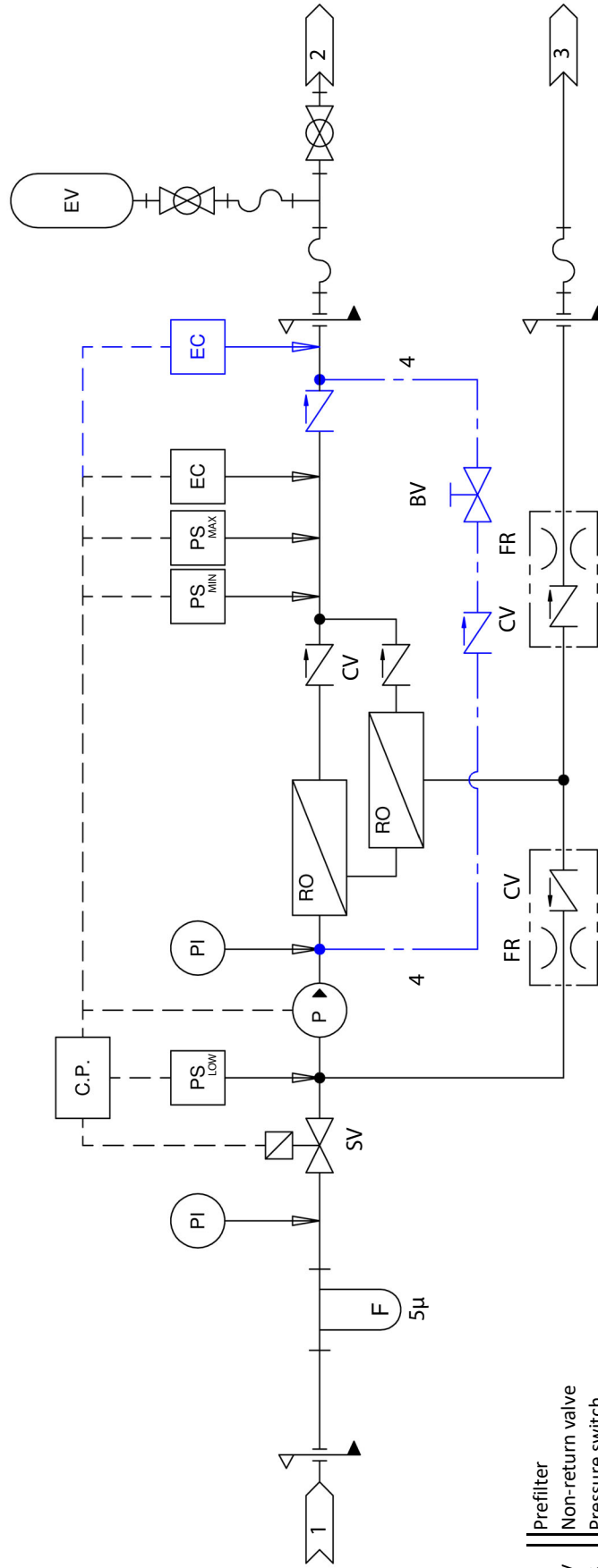

F	Prefilter
CV	Non-return valve
PS	Pressure switch
BV	Manual ball valve
C.P.	Control
FR	Flow limiter
SV	Solenoid valve
PI	Pressure gauge
EV	Expansion vessel
RV	Manual control valve
EC	Conductivity sensor
1	Feed water
2	Permeate
3	Concentrate
4	Blending kit

ROC 140

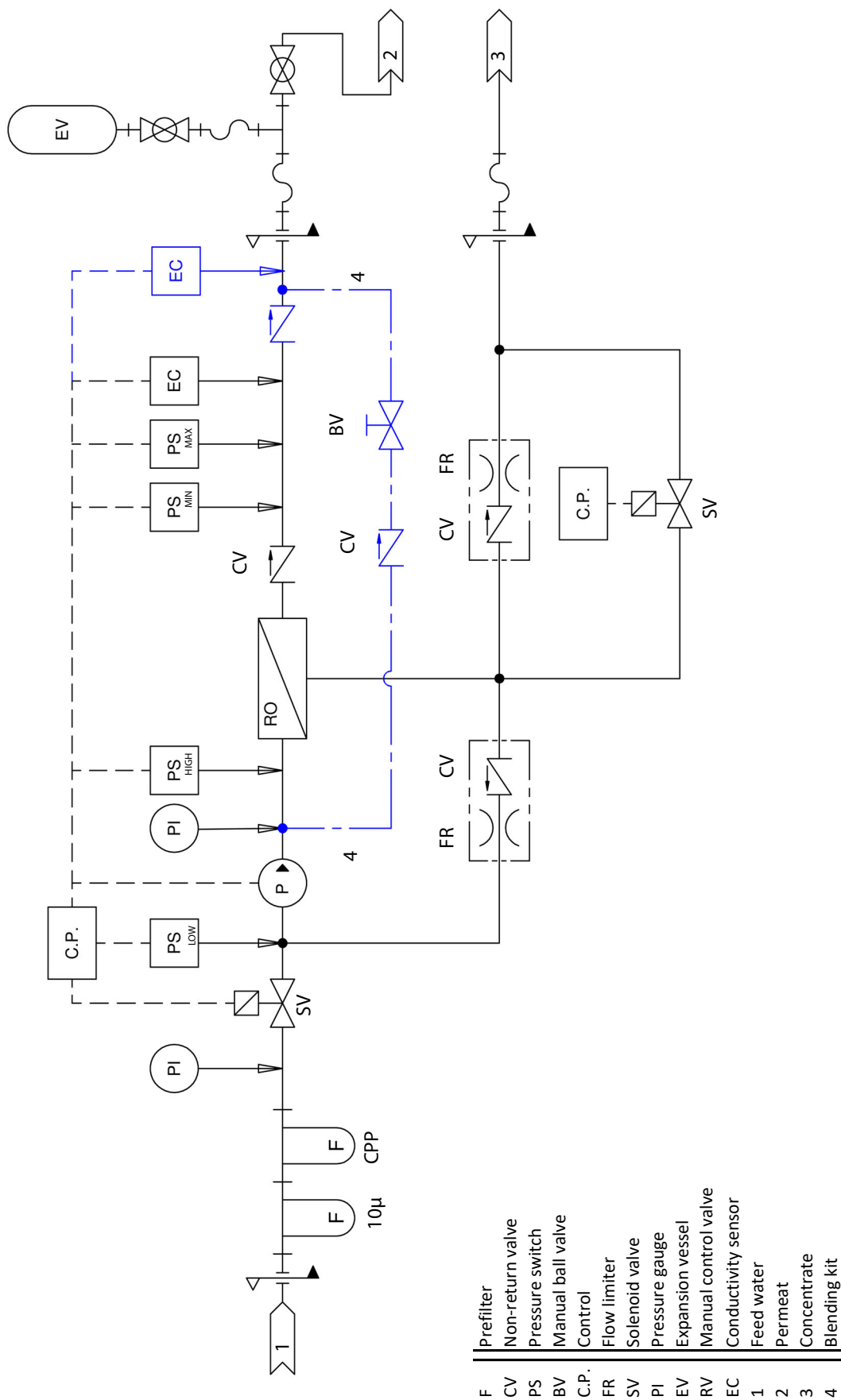

5. Mechanical installation

▲ WARNING

Risk of foot injuries!

Prevent unit from dropping during installation! Helping hand of a second person is advisable.

▲ WARNING

Risk of electrical shock!

Hazardous electrical voltage. During installation, the unit must be disconnected from power supply and secured against being switched on again. The absence of voltage must be ensured by a measurement.

5.1 Environment Parameters to be met and Mounting Recommendations

When selecting the installation site for the reverse osmosis unit, take the following into account:

- Installation in closed rooms requires aeration and, if necessary temperature conditioning in order to meet the environmental conditions.
 - Make use of existing water connections for supply and draining.
 - Mount the unit on a stable, preferably solid wall with the required load-bearing capacity required (s. unit technical specifications). If such a wall is not at hand, the unit may be attached to a stand bracket firmly anchored to the floor.
 - For correct operation it is necessary that the unit is mounted vertically and horizontally perpendicular.
 - The optimal feed water pressure of the reverse osmosis (RO) units is in the range of 2 bar to 5 bar. If these values are not reached, the installation of a pressure reducer or a booster pump is necessary.
 - The on-site waste water connection must be a free outflow according to DIN EN 1717.
 - The installation room must be well ventilated and equipped with a floor drain. Alternatively, a water stop device (e.g. leakage detector) can be used.
 - Install the reverse osmosis unit as close as possible to the consumer / humidifier. The maximum distance is 15 metres.
- The minimum clearances indicated in the fitting measures section must be observed in order to ensure adequate unit ventilation and allow for unobstructed access in case of maintenance
 - Protection class IP20
 - By design, HygroMatik reverse osmosis units are not qualified for outdoor installation (electrical components and water-bearing parts may be damaged)
 - Ambient temperature must lie between +5 and +40 °C (+41 and +104 °F) in order to protect the unit electronics against damage; frost may damage the solenoid valve and pump, as well as make hoses burst.
 - Avoid environments with excessive humidity, as it could have negative effects on the electronics.

5.2 Installation steps

5.2.1 Feed water connection

- » Connect the feed water inlet to the system. The diameter of the raw water pipe must be at least equal to the diameter of the connection piece.

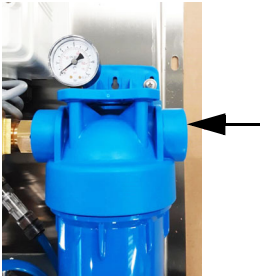

- » Observe the information in the technical data.
- » Connect a shut-off valve upstream of the system.

5.2.2 Permeate line connection

- » A short piece of hose is installed at the outlet port of the permeate in the factory. Remove this and replace it with the white hose Ø10 mm (included in the scope of delivery).



NOTICE

Never use the RO unit with the permeate line closed!

5.2.3 Connection of the expansion vessel

- » Mount the holder* of the expansion tank on a stable wall.
- » Seal the thread of the holder* (e.g. with Teflon tape).
- » Mount the expansion tank on the holder*.
- » Install the adapter* under the holder.
- » Connect the following fitting to the Ø10 ball valve with a piece of white hose (diameter 10 mm).



- » With the rest of the hose, connect the ball valve to the T-piece.

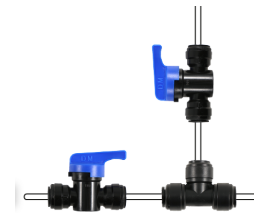

NOTICE

The expansion tank should be installed 3 - 5 m close to the R.O. unit.

NOTICE

Do not connect the permeate line to the expansion vessel until all other commissioning steps (especially flushing the membranes) have been completed.

* Included in the delivery of the optionally available expansion vessel.

5.2.4 Connection of the concentrate line

- » Connect the free connection of the flow limiter (with integrated back-flow preventer) with the black hose (Ø see technical data) with slope to a free flow.

NOTICE

Ensure a free outlet and discharge according to DIN EN 1717. Pay attention to the minimum requirement for the free flow distance (between the drain hose and the siphon) of 26 mm to prevent microbial contamination.

NOTICE

The colour of the supplied hoses indicates their use:

White: for permeate Black: for concentrate
(PE hose connection: "John Guest" plug connection)

5.2.5 Inserting the prefilter cartridge(s)

Before installing the filter set in the prefilter container, it must be ensured that the feed water line is closed and thus no pressure is applied.

- » Remove the filter container(s) using the screw driver supplied.
- » Then install the new filter insert as shown.
- » Refit the filter container(s) and screw tight.

NOTICE

If there are two prefilters (WL-ROC-140), insert the green activated carbon filter first.

Prefilter and membrane position



Fig. WL-ROC-25

5.2.6 Inserting the membrane(s)

Before installing the membranes in the membrane container, it must be ensured that

- the feed water line is closed and thus no pressure is applied.
- the unit is out of power.

WL-ROC-25/-40/-80:

- » Unscrew the cap of the membrane container and install the membrane.
- » Pay attention to the installation direction (black lip seal downwards).
- » Make sure that the membrane is correctly inserted.
- » Tighten the closure of the membrane container.

WL-ROC-140:

- » Unscrew the two quick fasteners (1) on the left-hand side of the membrane pressure pipe and catch the leftover water.
- » "Remove the two Allen screws (2) and the half-moon shaped fastening rings (3) from the slot of the membrane pressure tube.

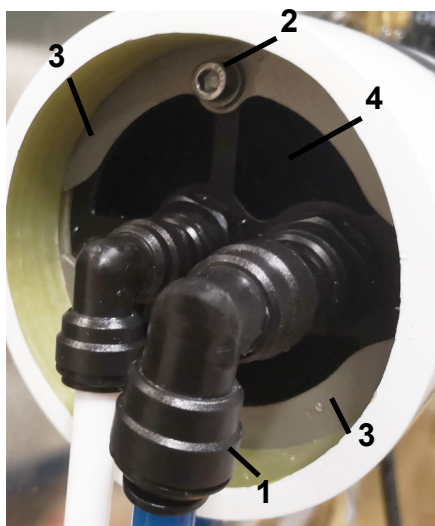

- » Pull the end cap (4) out of the membrane pressure tube.
- » Pull out the membrane (5) from the **left side** of the membrane pressure tube.

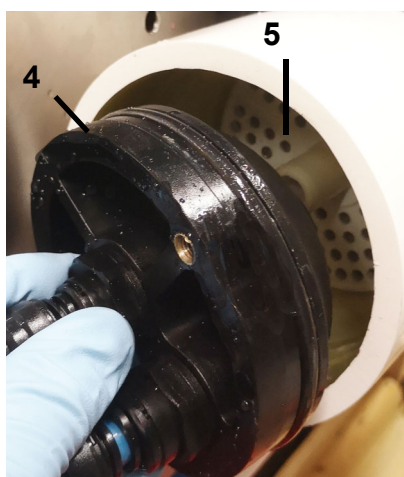

- » Ensure the correct installation direction and insert the membrane from the **right side** into the membrane pressure tube (6).



- » Put the end cap back into the membrane pressure tube and fasten it with the half-moon shaped fastening rings (3) and the Allen screws (2).
- » Finally, connect both quick fasteners (1).

NOTICE

Use disposable gloves when installing the pre-filter(s) and membrane(s) to protect them from contamination.

- » Continue with the commissioning (chapter 8.1) and flushing of the membrane.

6. Water connection

Have all plumbing work done only by qualified personnel (plumber or specialist with equivalent training) to minimize risks..

▲ WARNING

Risk of electrical shock!

Hazardous electrical voltage!

Before starting installation work ensure that the unit is not yet connected to the power supply.

General Rules

- Obey local water utility regulations
- Verify that necessary safety measures have been taken – in compliance with either German Technical and Scientific Association for Gas and Water (DVGW) guidelines (DIN EN1717) or local regulations – that eliminate back-flow of polluted water into drinking water treatment facilities. This may require the installation of a system separator, allowable only when free discharge into the drainage system is given.
- Ensure that there is a free outflow and drain according to DIN EN 1717. Pay attention to the minimum requirement for the free flow distance (between the drain hose and the siphon) of 26 mm to prevent microbial contamination.
- Supply water must not exceed 25°C (77°F)
- Allowable range of water pressure: 1,5 to 4 bar / 22 to 58 psi (150.000 to 400.000 Pa). If the pressure is below 1.5 bar, install a pressure booster, if it is above 4 bar, install a pressure reducer after the reverse osmosis system.
- Install a drain tap shortly before the system to flush the pipe. Flushing the pipe prevents foreign particles such as swarf or sealing material from entering the system from the pipes.

Connection of the system supply

- » Make sure that the flow rate and pressure correspond to the values given in the technical data.
- » Ensure that the water supply stays closed. This system may only be supplied with water during commissioning (see chapter 8) !

Connection of the concentrate discharge pipe.

- The diameter of the concentrate pipe must be at least equal to the diameter of the connection piece (see technical data).

NOTICE

In any case, a particle filter (min. 100 µm) according to DIN 13443-1 should be installed before the reverse osmosis system. Without a water filter there is a risk of damage to the system.

NOTICE

The following applies to WL-ROL units:

- For safety reasons the water connections are not screwed during transport. They must be screwed during installation.
- Remove the transport locks from the flow pipes.

Water connections final check

Go down the following water installation checklist:

- ALL screw connections and hoses firmly connected?
- Water supply line flushed before making connections?
- Water connection properly installed?
- Water discharge properly installed?
- Does blow-down water drain freely?
- Water supply line and water discharge leakage-free?

7. Electrical connection

⚠ WARNING

Risk of electrical shock!

Hazardous electrical voltage.

All work related to electrical installation to be performed by expert staff (electricians or expert personnel with equivalent training) only. Do not connect the reverse osmosis unit to the live power supply before all installation work has been completed.

Please note

The customer is responsible for checking expert staff qualification.

General installation rules

- All local rules concerning the implementation of electrical installations must be obeyed.
- Electric connector cables to be laid professional.

NOTICE

Possible electronical components destruction through electrostatical discharge!

Prior to commencing electrical installation work, steps must be taken to guard the sensitive electronical components of the unit control against damage from electrostatical discharge.

7.1 Procedure for electrical installation

- » Insert the plug into a suitable socket. The performance values are given in the technical data.

No further wiring is required.

Exceptions:

- Connection of the internal alarm output to an external alarm detector
- Connection of a dosing pump (WL-ROC-140)

Fuses

Please note

HygroMatik recommends the use of main fuses with slow- to medium-load characteristic.

The reverse osmosis system should be operated by its own residual current circuit breaker.

7.2 Electrical installation check list

Check electrical installation with respect to customer-site requirements and local power supply regulations.

- Supply voltage in accordance with name plate voltage rating?
- Have all electrical cable and plug connections been properly tightened?

7.3 Inputs and outputs of the main board

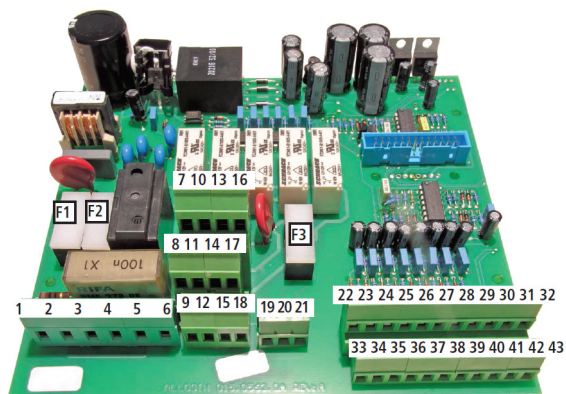

clamp	description	WL-ROC-025/-040	WL-ROC-060	WL-ROC-140
1[L] - 2[earth] - 3[N]	230-V 50/60 Hz-Input for system power supply	x	x	x
4[L] - 5[earth] - 6[N]	230-V-Output for pump supply	x	x	x
7[L] - 8[earth] - 9[N]	230-V-Output for dosing pump	/	/	x
10[L] - 11[earth] - 12[N]	230-V-Output for inlet valve	x	x	x
16[L] - 17[earth] - 18[N]	230-V-Output for flush valve	/	/	x
19[NO] - 20[C] - 21[NC]	alarm output optional	x	x	x
22[C] - 23[IN]	input pressure switch Feed water connection / Max pressure	x	x	x
24[C] - 25[IN]	input high pressure switch pump pressure	/	/	x
28[C] - 29[IN]	input alarm dosing pump	/	/	x
30[shielded] - 31 - 32	conductivity sensor feed water	/	/	x
33[C] - 34[IN]	input pressure switch Feed water connection / Min pressure	x	x	x
35[C] - 36[IN]	input low pressure switch	x	x	x
37[C] - 38[IN]	input Remote-On/Off optional	x	x	x
39[C] - 40[IN]	input softening filter	x	x	x
41[shielded] - 42 - 43	conductivity sensor row water	/	/	/

8. Initial start-up and flushing of the membrane(s)

When the system is started for the first time and each time it is put into operation after a period of non-use, you must remove the chemical maintenance solutions and/or standing water. If the system is not used for a longer period of time, the membrane(s) must be replaced

⚠ WARNING

Risk of electrical shock!

Hazardous electrical voltage!

Follow safety instructions for work on live components.

NOTICE

Do not use the water produced during this phase.



- » Lead the hose for the permeate into the drain
- » Make sure that the water supply is interrupted
- » Close the valve to the expansion vessel
- » Insert the membrane(s) and the 5µm prefilter into the pressure pipes
- » Screw the covers of the pressure pipes tight
- » Connect the unit to the power supply. The system goes into error mode due to lack of water
- » Press "ENTER" for two seconds, the display shows: "PASSWORD 0000".
- » Enter the service-password (see additional information attached to the unit/ membrane)
- » Confirm with "Enter"
- » Select **menu item 14** (system test)
- » Open the water supply (solenoid valve) to the unit
- » Press  (Open the water inlet valve / activate the solenoid valve to flush the membrane(s)).

- » Let the system run for 10 minutes



- » Press  (switch on the pump)
- » Check the system for leaks
- » Let the system run for another 10 minutes



- » Press  (switch off the pump)
- » Press  (this close the water inlet valve/ solenoid valve)
- » Open the valve of the expansion vessel
- » **Press "ESC" twice** (leaving the service level). The system starts to produce permeate
- » Check whether the unit switches off after reaching the operating pressure (approx. 4 bar).
- » Connect the permeate line to the expansion vessel

NOTICE

- At the start of each commissioning with the use of new membrane(s), the WL-ROC unit produces a higher permeate quantity in the first 2-4 hours, which is also accompanied by higher conductivity.
- Observe the note on the influencing factors (see chapter 4.1 mode of operation).
- The measured permeate conductivity value shown on the display of the controller will settle down to the actual value within the first minutes.

8.1 System start-up after initial commissioning

▲WARNING

Danger due to incorrect operation!

Commissioning may only be carried out by qualified personnel (electricians or specialists with equivalent training)..

NOTICE

The pump may only be operated with the water inlet valve open, otherwise it could be damaged. Exception: first commissioning.

Step 1: Check mechanical integrity, water connection and cabling

- » Check functionality of water and electrical installation.
- » Check functionality of the pre-treatment system (if available).

Step 2: Check the feed water

- » Check whether the feed water parameters are within the limits specified in chapter 4.3.

Step 3: Switch on the unit

- » Switch on the main fuse
- » Open the water supply shut-off tap
- » Insert the power plug

Step 4: Observe device and check for leaks

- » Let it run for 15 to 30 minutes
- » If leaks occur, switch off the unit immediately.

Step 5: Remove leaks

- » Locate and eliminate leaks
- » Repeat leakage test

Step 6: Connecting the permeate line to the expansion tank

- » see chapter 5 **mechanical installation**

8.2 Adjusting the metering pump

The WL-ROC140 allows the use of the optionally available antiscalant dosing pump.

When using the recommended antiscalant Pragmaclean 309, proceed as follows:

- » Position the flow control knob at 30%



When the activity LED is green, the metering pump supplies an amount 10 times higher than the nominal value. Only use this setting after consultation with the specialist dealer or HygroMatik.

In **standard operation**, you use the dosing pump with the divider switched on (**orange LED lights up constantly**).

To supply the dosing pump with the antiscalant mixture from the canister, proceed as follows:

- » Switch off the divider, the colour of the LED changes to green.

The **DIVIDER** is switched on and off as follows:

- » **Short press** on the ON/OFF button (pump goes into standby mode).
- » **Long press** on the ON/OFF button, after 4 short flashes the LED changes colour. Only then release the pressure on the button
- » Set the rotary knob to 100% (fast pulse frequency).
- » Open the vent screw (A)

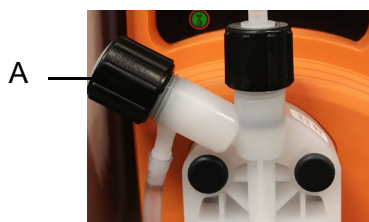

- » Close the vent screw (A) when the transparent tube is completely filled with the antiscalant mixture.

When the antiscalant mixture reaches the pump, the "knocking noises" of the dosing pump become quieter.

- » Set the rotary knob to 30%.

When the antiscalant mixture is transported bubble-free in the tube:

- » Switch on the divider, the **orange LED** lights up continuously.

NOTICE

During operation, you can directly change the frequency of the dosing pump via the control knob.

ED flashing states

status LED (flashes per sec.)	status pump operation
3x RED	Pump powered but voltage too low
2x RED	Pump powered but voltage too high
2x ORANGE	Pump OFF and powered
leuchtet ORANGE, schaltet bei jedem Klopfen aus	Pump ON
always on (RED)	Level alarm

NOTICE

When using the recommended antiscalant Pragmaclean 309, dose it according to the feed water quality (see technical data).

Only use diluted antiscalant!

9. Maintenance

9.1 General

Regular maintenance is essential to ensure that the HygroMatik units can achieve a long service life. The necessary maintenance work refers to components that are either subject to mechanical or electrical wear, or whose function is reduced by deposits.

The optimum function and required maintenance intervals of a reverse osmosis unit depend mainly on the existing water quality and the permeate quantity produced. Different water qualities can extend or shorten the maintenance intervals.

The following factors in specific could lead to an early blocking of the membranes:

- Blockage as a result of the deposit of iron or calcium sulphate and calcium carbonate
- Blockage with organic material

In general, a replacement of the membranes becomes necessary if a change in the following basic system parameters (at the same temperature and salinity) is noticed:

- Reduction of the permeate production to a value which is insufficient for the application downstream of the reverse osmosis system.
- Too much increase in the conductivity of the water produced to a value too high for the application downstream of the system.
- Increase of the membrane feed pressure.

9.2 Safety instructions for maintenance

⚠ WARNING

Risk of electrical shock!

Hazardous electrical voltage!

Any work on the electrical system to be performed by certified expert staff (electricians or expert personnel with comparable training) only.

NOTICE

Take care of ESD protection!

The electronic components of the control are very sensitive to electrostatic discharges. In order to protect these components during maintenance, steps must be taken to guard against damage from electrostatic discharge.

NOTICE

Removal and replacement of components

If necessary, the parts of the UO unit may only be replaced by qualified personnel. Replacement work must always be carried out with the system at a standstill; contact the supplier or the manufacturer directly for this purpose.

NOTICE

Use disposable gloves when installing the pre-filter(s) and membrane(s) to protect them from contamination.

9.3 Change prefilter



Before replacing the prefilter, check

- that the WL-ROC system is switched off
 - the inlet valve is closed and there is no pressure on the water line.
- » Remove the pre-filter with suitable tools.
- » Remove the old filter cartridge and clean the inlet.

- » Replace the O-ring if necessary.
- » Moisten the new O-ring and insert it.
- » Insert a new filter cartridge.
- » Mount the pre-filter with suitable tools.
- » Open the feed water supply.

9.4 Membrane exchange

Before replacing the membrane(s), check the following:

- The WL-ROC unit is switched off.
- The inlet valve is closed, there is no pressure on the water line.
- » Disconnect the black hose from the membrane container.
- » Unscrew the cover and pull out the old membrane cartridge.



- » WL-ROC-140: Open the lids on both sides of the container and slide the membrane cartridge out through the left opening.
- » Remove the protective foil from the new membrane.
- » If necessary, moisten the membrane cartridge with clean glycerine.
- » Push the membrane cartridge carefully into the white membrane container without damaging the seal.
- » WL-ROC-140: Insert the membrane cartridge through the right opening of the membrane container.
- » Close the lid(s).

- » Reconnect the black hose to the membrane container.

9.5 Maintenance scheme

9.5.1 Daily check

- » Check if the system is working correctly.
- » Check that there are no leaks in the water-carrying components.
- » Check the water inlet pressure.

NOTICE

The system supply pressure (after the pre-filters) must be at least 2 bar during normal operation. Replace the filter cartridges if the pressure loss is too high.

9.5.2 Weekly check

- » Check the max. diaphragm pressure (max.10 bar!).
- » Check the hardness of the water entering the system (20°dH)
- » Check the water conductivity of the permeate with the control unit.
- » Note down the data for the listed tests

NOTICE

- Note that the production quantity of the permeate increases with rising water temperature, while the quality of Permeate is decreasing. Conversely, the production quantity decreases with decreasing temperature, while the quality of the permeate improves.
- The indication of the measured permeate conductivity value on the display of the control unit settles down to the actual value within the first minutes.

9.5.3 Maintenance every two months

- Check that there is not too much free chlorine at the outlet (less than 0.25ppm).

Replace the prefilter cartridge::

- » Every 2 months if the free chlorine content is between 0.15 ppm and 0.25ppm.
- » Every 4 months if the free chlorine content is less than 0.15 ppm.

NOTICE

The lifetime of the pre-filter and membrane(s) depends on feed water quality and permeate production rate.

9.5.4 Maintenance by qualified personnel

every 6 months:

Check the pre-filling pressure of the expansion vessel. This value must be 1.5 to 1.8 bar. To check the pressure, the outlet line of the vessel must be temporarily interrupted.



A pressure gauge can also be permanently connected to the top of the expansion tank (up to 80l/ 1/8") for reading.

Generally:

- » Check the parameters of the water entering the system.
- » Check the conductivity of the feed-water and permeate with a conductivity meter.
- » Record the data for the listed tests.

Maintenance schedule

unit / spare part	min. every 2/4 months		every 12 months UV lamp	as needed		
	sediment filter	carbon filter		membrane (s)	o-ring	number
WL-ROC25	/	ROKC00FLT1	ROKC00UVLA / ROKC00UVOR	ROKC00MEMB	/	1
WL-ROC40				ROKC00ME00		2
WL-ROC80				ROKC00ME14		1
WL-ROC140	ROKC00FLT3	ROKC00FLT2				

10. Decommissioning

The regular operation of the reverse osmosis unit is dependent on the continuous production of desalinated water.

Even during longer periods of non-use, the system must be connected to the power supply, as hygiene regeneration is regularly carried out in standby. Keep the power and water supply of the system connected.

If the system does not produce any permeate for more than 10 days, the membrane(s) must be replaced and rinsed before restarting (**see chapter Initial start-up and rinsing the membrane**).

10.1 Dismantling

Once the RO unit will no longer be used, dismantle (demolish or scrap) it by following the installation procedures in reverse order.

⚠ WARNING

Dismantling of the unit may only be performed by qualified personnel. Electrical dismantling may only be performed by trained electricians.

Please note

Obey the safety guidelines in section "Safety Instructions," especially the guidelines for disposal.

10.2 Disposal after dismantling

The reverse osmosis unit is made up of metal parts and plastic parts. In reference to European Union directive 2012/19/EU issued on 4 July 2012 and the related national legislation, please note that:

The components of the electrical and electronic devices must not be disposed of as municipal waste, and therefore the method of waste separation must be applied. The public or private waste collection systems defined by local legislation must be used.

NOTICE

The operator is responsible for the disposal of unit components as required by law.

11. Control

The whole operation of the reverse osmosis unit WL-ROL is controlled by a microprocessor.

The control-system enables the production process and the control of the RO-unit. The measured values are shown on a LC-display. The control has the protection class IP65.

11.1 The control panel





The control panel is separated into three zones:

- the 2 operating keys ESC, ENTER
- the 4 arrow keys
- LC-display

The **operating keys** are used to navigate through the menus and submenus. The function of the keys is:

 „ESC“: Cancel or return to the previous level



 Arrow keys: Move within a menu, a submenu or a selection list

 „ENTER“: Acceptance and storage of a selected setting

By pressing the arrow keys  you can call up the read values:

- Permeate conductivity
- Operating hours
- Remaining time (hours) until the next service

Access to the main menu:

- » press  or about 2 sec, the display shows “PASSWORD 0000“
- » enter the password using the arrow keys (0077)
- » confirm with 

The control system regulates the automatic sequence for start-up, production, process shut-down, as well as for periodic rinses by controlling the following actuators:

- Feed water valve (V_{FEED})
- Permeate flush valve (V_{PER})
- High pressure pump (P_{HP})
- Dosing pump Antiscalant (P_{ASC})
- Fault signal/alarm (potential-free changeover relay)

The controller is equipped with the following digital inputs for monitoring the process:

- Overpressure switch (PS_{HIGH})
- Low pressure switch (PS_{LOW})
- Level of permeate vessel low (PS_{Min})
- Filling level permeate vessel full (PS_{MAX})
- External stand-by signal (IN_{SB})
- Error dosing pump antiscalant (IN_{PASC})
- Malfunction feed water pre-filter (IN_{FIL})

Furthermore, the controller has a conductivity measurement (not temperature compensated) for monitoring the permeate quality, with a freely adjustable limit value.

This means that the unit is switched off and a fault message is output if the limit value of the permeate conductivity is exceeded during operation.

The different operating states

Permeate production: Production of product water. The V_{FEED} , P_{HP} and P_{ASC} relays are energized.

STAND-BY: Unit is waiting on request. The unit is ready for operation, all relays are off.

Flushing (to prevent deposits on the membrane surface): Factory activated in the main menu, flushing (when the unit is switched on), before/after water production and/or cyclically after a certain number of hours. The cyclic flushing can also be done in STAND-BY mode.

NOTICE

Never deactivate the flushing function!
(Avoidance of microbial contamination)

The production is controlled by the two level switches in the permeate tank:

- PS_{HIGH} starts the production
- PS_{LOW} stops production

In the MinPressure condition, the unit starts the water production: it opens the input solenoid valve and starts the pressure pump.

To avoid damage, a delay of 3 seconds is given after the input solenoid valve has opened.

When the MaxPressure condition is reached, the control unit goes into stand-by mode: the input solenoid valve closes and the pressure pump stops.

In the menu it is possible to deactivate one or both level switches and to operate the system with only one or no level switch at all. If both level switches are deactivated, the system goes into continuous production after switching on the power supply.

When the controller is switched on, a module flush is first carried out (if activated in menu 11).

After switching on the control system and module flushing (if activated in menu 10), the control system goes into production mode if the Min. pressure condition is underrun.

If programmed in menu 11 **CLEANING** the control unit starts an interval rinse during production as well as in standby (against stand-still contamination) as soon as the countdown for the rinse interval has ended. The countdown for the rinse interval is reset at each rinse.

11.2 Operating states

After switching on the power supply, the version number of the control software appears for a few seconds.

Then the controller returns to the last operating state before switching off.

The following operating states may appear:

WAITING
START PUMP

The unit starts after the preset start delay has ended.

CLEANING: TIME
LEFT xxM xxS

$PS_{LOW} = 0$ und $PS_{HIGH} = 0$

The permeate tank is empty. First, a module rinse is carried out when production is started (if it is programmed). Then the RO plant goes into production.

SYSTEM WAITING!
HIGH LEVEL

$PS_{LOW} = 1$ und $PS_{HIGH} = 0$

The filling level in the permeate tank is between empty and full. The unit goes into stand-by mode.

CLEANING: TIME
LEFT xxM xxS

SYSTEM WAITING!
HIGH LEVEL

$PS_{LOW} = 1$ und $PS_{HIGH} = 1$

The pressure switch PSHIGH switches. The permeate tank is full. The unit performs a module rinse (if programmed) and then goes into stand-by mode.

COND. PERMEATE
xxx μ S

Shows the permeate conductivity

SERVICE IN
xxxxx Hr

Shows the remaining time (in hours) until the next service.

WORKING TIME
xxxxx Hr

Shows the system operating hours.

SYSTEM WAITING!
IN FILTER

The IN_{FIL} input for the feed water pre-filter or for the hardness sensor has switched (example: potential-free contact of an upstream softening unit). The unit stops. If the input is free again, the plant restarts automatically.

SYSTEM STOPPED!
FAILED DOSAGE

The IN_{PASC} input for the Antiscalant dosing pump (optionally available for WL-ROC 140) has switched. The system stops. If the input is free again, the system restarts automatically.

**SYSTEM WAITING!
IN STAND BY**

The IN_{SB} input (external stand-by signal) has switched. The system stops. When the input is free again, the system restarts automatically.

**PERFORM
MAINTENANCE**

The service hour counter has been counted down. Please make a maintenance and reset the counter..

11.2.1 Alarm messages

If one of the following alarm messages appears, the system stops and the alarm relay switches on.

This message cannot be confirmed!

- » Disconnect the system from the power supply and eliminate the cause of the alarm.

Further information can be found in the chapter Troubleshooting.

**SYSTEM STOPPED!
HIGH PRESSURE**

The overpressure switch PS_{HIGH} for the max. permitted operating pressure has switched. The system stops.

**SYSTEM STOPPED!
LOW PRESSURE**





The low-pressure monitor PS_{LOW} for the minimum acceptable feed water inlet pressure has switched. The system stops.

**SYSTEM STOPPED!
HIGH COND. OUT**

The max. limit value for the permeate conductivity has been reached. The unit stops.

You can return from the operating display level to the main menu by pressing the ENTER key.

11.3 Menu navigation

- » use the arrow keys   to move through the main menu to the relevant parameter
- » press "ENTER" , to go to the selected submenu
- » press "ESC"  for about 2 seconds to return to the main menu



Button < UP >:



Button < DOWN >:

At the operation display level: To scroll up/down the operation displays.

At the menu level: To scroll up/down the menu level.

In the relevant parameter: To count down the input value, and to enable (ENABLE) or disable (LOCKED) a function.



Button < LEFT >:

In the menu: For jumping back to the previous digit within the input field.



Button < RIGHT >:

In menu: For jumping to the next digit within the input field.



Button < ESC >:

In menu level: To leave the menu level and return to the operating display level.

In the parameter: To return to the previous iA longer press (2 sec) switches the system off and on. nput field/display or to leave the menu.

Pressing the button for a longer time (2 sec) switches the system off and on.



Button < ENTER >:

In the operating display level: To open the menu level.

At menu level: To open a menu.

In the parameter: To save the entry and jump to the next entry field or return to the menu level.

NOTICE

By "jumping back with ESC" the earlier entries in this menu item are not saved!



Always end the menu items with "Skip to next" by pressing the ENTER key until the menu item starts again. This is the only way to save the settings you have made.

11.4 Setting options at operator level

The following factory-set parameters can be changed at the operator level (password 0077)

Setting the required conductivity:



3B LIMIT OUT
xx,x µS

By pressing the arrow keys   you can set the max. set point

» Confirm the selection with 



Setting the required flushing time / flushing cycle:

11G TIME
00 min 00 sec

By pressing the arrow keys   you enter the duration of the flushing time for the periodic module flush..

» Confirm the selection with . The program jumps to submenu "11H".

11H WASH CYCLE
00 min 15 sec 24 h

By pressing the arrow keys   you specify the time period between the periodic module flushes.

e.g. change 24h to 48h (usage pause)

» Confirm the selection with . The program jumps back to the main menu.

NOTICE

In the factory settings, parameter 11 **CLEANING** is preset to ON. If this setting has been changed to OFF in the service level, no entries can be made here in the operator level.



Setting the required language:

In this submenu you can select the language shown on the display.

16 LANGUAGE
17 SET PASSWORD



LANGUAGE
ENGLISH

» Press the arrow keys   to select your language

» Confirm the selection with . The program jumps back to the main menu.

11.5 Menu Structure

The following menu list gives an overview of all parameters of the unit control.

At the operator level (password 0077) only the parameters shown here in dashed lines can be changed. The other parameters are only visible at the operator level. Changing them is only possible at the service level.

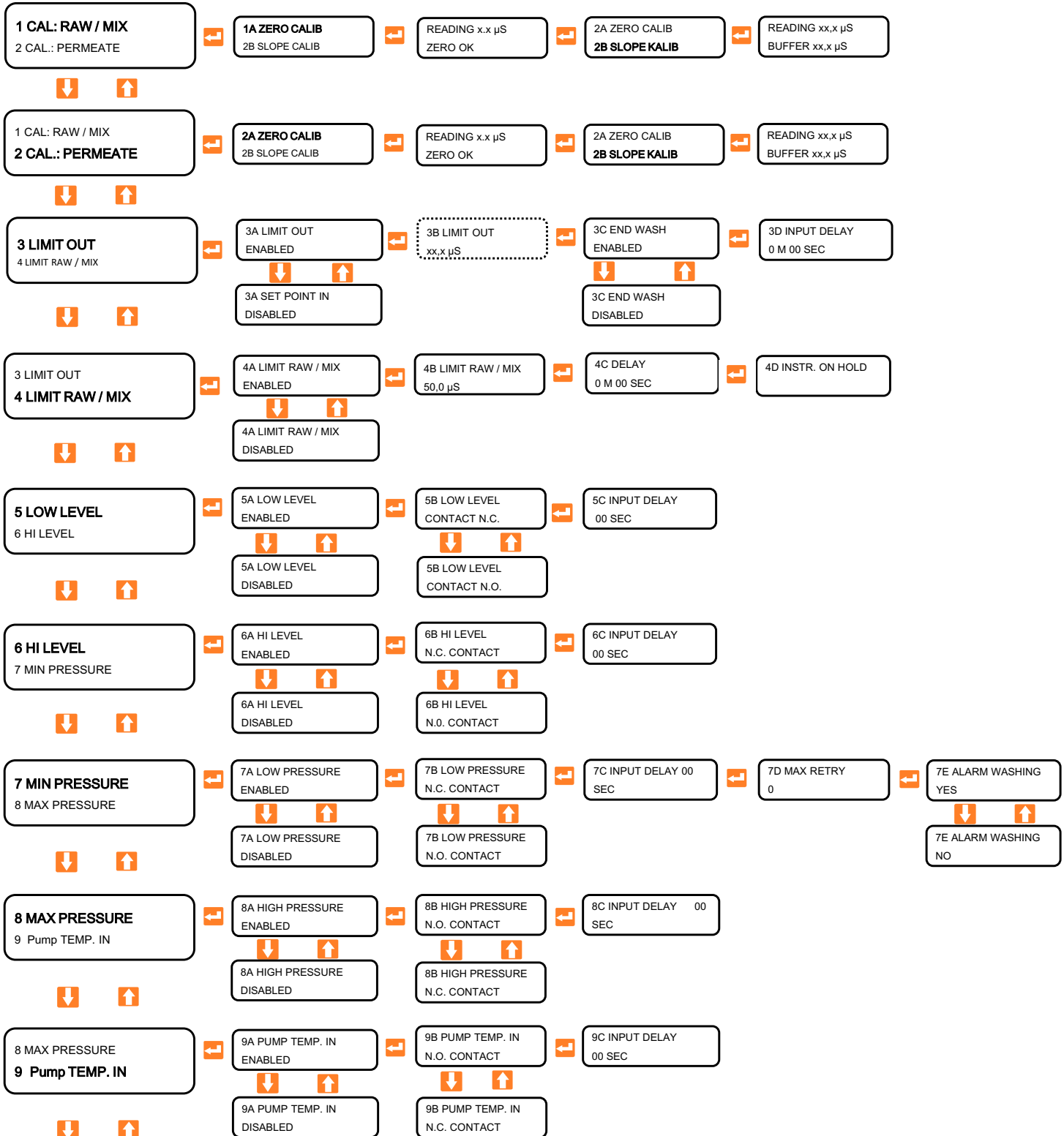

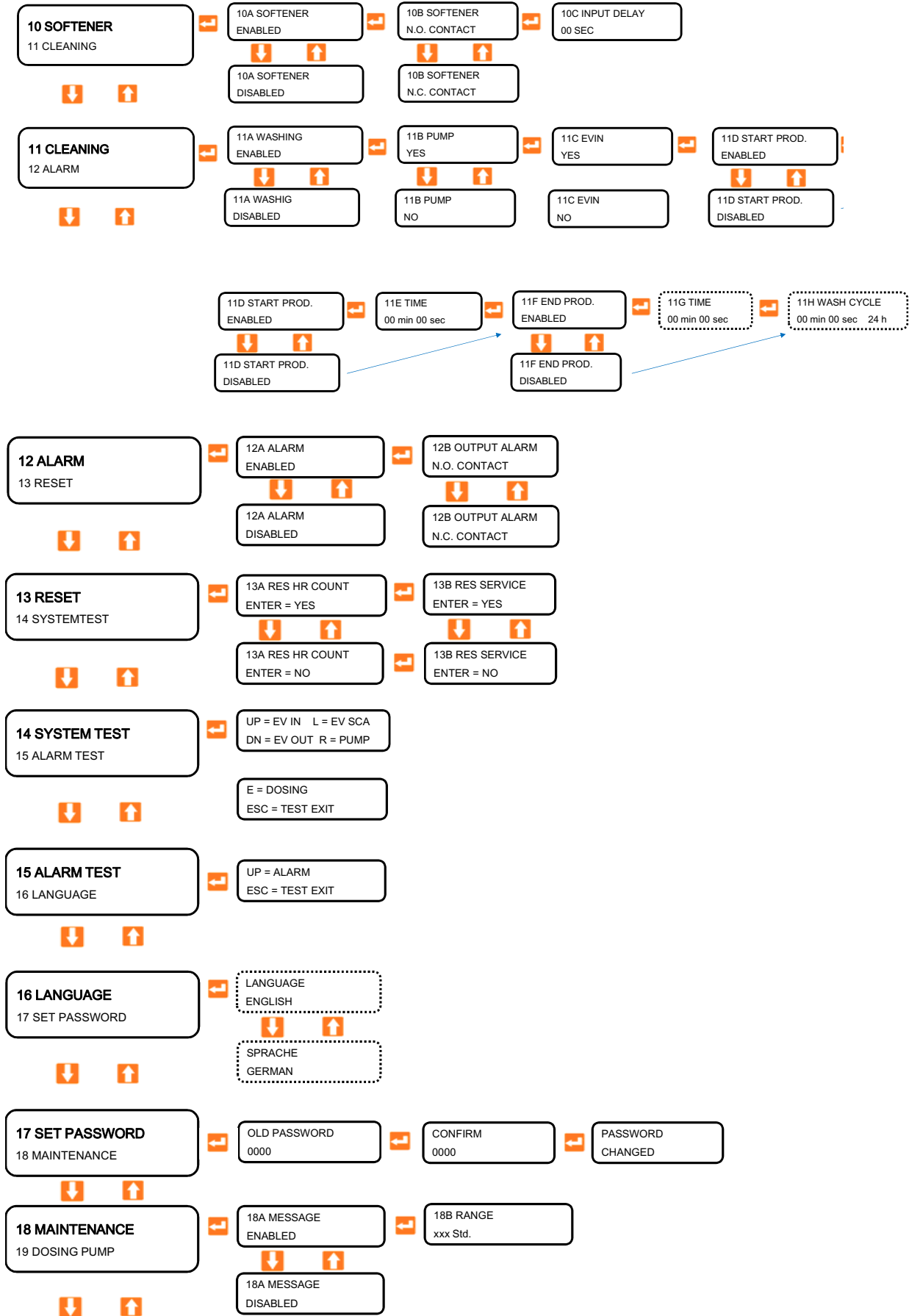

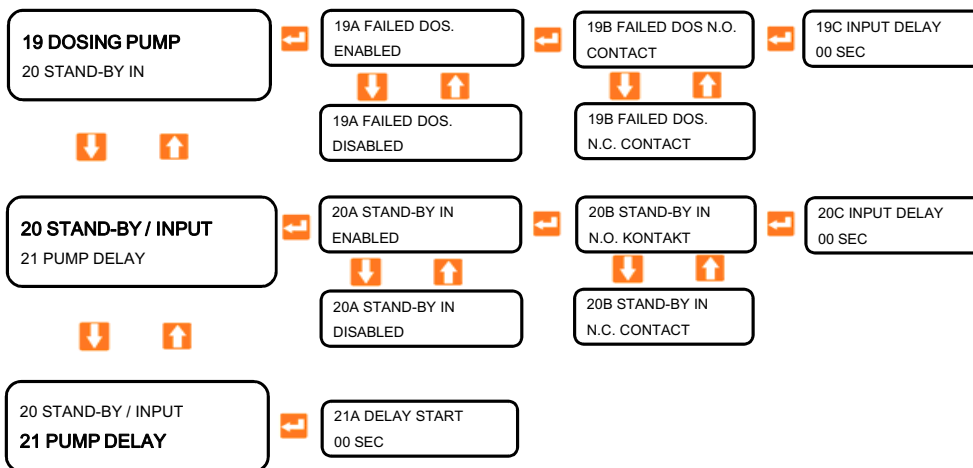

11.6 Setting options at service level

The following chapter is only intended for certified service staff. The password for reaching the service level can be found in the additional information provided with the unit. HygroMatik is not liable for damages caused by incorrect parameter settings at this level.

NOTICE

The parameters have already been configured ex works and may only be changed with the appropriate expertise.

The contact configuration is preset in all submenus. Do not change this carelessly! Otherwise there is a risk of damage to the system.

11.6.1 Conductivity sensors

The HygroMatik RO units WL-ROC 25-80 are equipped with one conductivity sensor (permeate).

The WL-ROL units (and WL-ROC-140 with blending kit) are equipped with two conductivity sensors. One sensor measures the conductivity of the feed water (ROH/ MIX), the other sensor that of the permeate. Both conductivity sensors are pre-calibrated ex works.

1 CAL. ROH- / MIX
2 CAL. PERMEATE

In the case of recalibration during maintenance, the calibration can be carried out either with the help of a buffer solution with known conductivity, or with a conductivity tester according to the principle of comparative measurement.

NOTICE

When selecting the calibration liquid (not included in the scope of delivery), please note the selected measuring range:

- Note that this conductivity measurement is not temperature-compensated.
- To achieve a high measuring precision it is therefore recommended that the calibration liquid (or the water sample for the comparison measurement) has approximately the same conductivity and temperature as the permeate to be measured.

Display shows three lines:



After a few minutes of running time, measure the conductivity of the permeate and/or raw/mixed water with an external conductivity meter and enter the measured value in the corresponding parameter:

3 LIMIT OUT

- » Press + at the same time
- » Press ENTER to calibrate
- » Press ESC to exit without calibrating

4 LIMIT ROH-/MIX

- » Press + at the same time
- » Press ENTER to calibrate
- » Press ESC to exit without calibrating

11.6.2 Calibration of the probe zero point

- » Remove the conductivity probe from the flow assembly and dry it.
- » Select **2A CAL ZERO** in the main menu

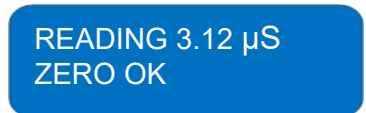

A conductivity value is now displayed in the upper line.

- » Confirm the selection with

The display value may be > 0 µS, but should remain < 50 µS, otherwise the controller would not accept the calibration. In this case the conductivity probe may be faulty and must be replaced. The display shows the message "ZERO ERROR cal."



- » repeat the calibration or quit the parameter without saving with

11.6.3 Calibration of the probe slope

2A ZERO CALIB
2B SLOPE CALIB



READING 12,5 µS
BUFFER 15,0 µS

- » In the main menu, select **2B SLOPE CALIB**
- » Enter the conductivity of the buffer solution in the "BUFFER" field according to the table on the bottle label.
- » Hold the sensor in the buffer solution and wait until the "READ" value has stabilized.
- » press  , to confirm the displayed slope value and exit the parameter
- and press  , to return to the main menu
- or
- » press  to exit the parameter without saving



The buffer value must not be 0, otherwise the calibration is not saved.

11.6.4 Permeate set point calibration

With the assistance of the permeate conductivity measurement and a freely adjustable limit value for the permeate conductivity, the unit can be stopped and an alarm message issued if the permeate quality is reduced.

- » Select **3 LIMIT OUT** in the main menu



3 LIMIT OUT
4 LIMIT RAW/MIX

Press the arrow keys   to select whether the set point function should be active or inactive.

3A LIMIT OUT
ENABLED

- » Confirm the selection with 
- If the set point function has been activated, the program jumps to submenu "3B"..



3B LIMIT OUT
50,00 µS

By pressing the arrow keys   you can set the max. set point

- » Confirm the selection with  . The program jumps to the submenu "3C".

If the permeate conductivity exceeds the limit value set here during production, the system stops, the alarm message "ALARM CONDUCTIVITY" appears on the display and the alarm output relay picks up.

3C END WASH
ENABLED

By pressing the arrow keys   you can select in the submenu "3C FLUSH TIME END" the reaction of the control system when the set point is reached at the end of a module flush.



SWITCHED ON: At the end of module rinsing before the transition to the standby state, the permeate conductivity exceeds the limit value. The alarm message "ALARM CONDUCTIVITY" appears on the display and the alarm output relay picks up.

The unit stops.

OFF: The conductivity control during and after module rinsing is deactivated.

- » Confirm the selection with . The program jumps to the submenu 3D".

3D DELAY
0M 00Sec

Enter a delay time by pressing the   arrow keys. The delay is intended to prevent the system from being switched off abruptly due to temporary measurement value peaks.

0 Sec = no delay

(Causes an immediate switch-off when the set max. conductivity value is reached. See note at the end of the chapter)

- » Confirm the selection with . The program jumps back to the main menu.



If a module flush is followed by a longer standstill period, an increased conductivity value may temporarily occur. If the parameter 3C is set to ON, this will lead to an unintended shutdown of the system

11.6.5 RAW/MIX set point calibration

With the assistance of the feed water conductivity measurement and a freely adjustable limit value for the conductivity, the unit can be stopped and an alarm message issued if the feed water quality is reduced.

- » Select **4 LIMIT RAW/MIX** in the main menu

4 LIMIT RAW/MIX
5 LOW LEVEL



Press the arrow keys   to select whether the set point function should be active or inactive.

4A LIMIT RAW/MIX
ENABLED

- » Confirm the selection with 

If the set point function has been activated, the program jumps to submenu "4B"..



4B LIMIT RAW/MIX
xx,xx µS

By pressing the arrow keys   you can set the max. set point

- » Confirm the selection with . The program jumps to the submenu "4C".

If the feed water conductivity exceeds the limit value set here during production, the system stops, the alarm message "ALARM CONDUCTIVITY" appears on the display and the alarm output relay picks up.

4C DELAY
ENABLED



Enter a delay time by pressing the   arrow keys. The delay is intended to prevent the system from being switched off abruptly due to temporary measurement value peaks.

0 Sec = no delay

(see note at the end of the chapter)

» Confirm the selection with . The program jumps to the submenu 4D".

4D INSTR. ON HOLD
YES

Press the arrow keys   to select whether the set point function (monitoring of the conductivity limit value during production) should be active or inactive.

YES= active

NO = inactive



Confirm the selection with . The program jumps back to the main menu.

11.6.6 Lower level switch LS_{Low}

With the aid of the level switch, the minimum fill level in the permeate vessel can be monitored and the system can be started automatically if the pressure falls below the required level.

» Select **5 LOW LEVEL**

5 LOW LEVEL
6 HIGH LEVEL

» Press the arrow keys   to select if pressure switch should be active or inactive.

5A LOW LEVEL
ENABLED

ENABLED= active

DISABLED = inactive

(not recommended)

» Confirm the selection with .

If the set point function has been activated, the program jumps to submenu "5B".

5B LOW LEVEL
CONTACT N.O.



Press the arrow keys   to set the switching direction.

N.O. CONTACT = The input functions as a normally open contact.

N.C. CONTACT = The input works as a normally closed contact

» Confirm the selection with . The program jumps to submenu "5C".

5C INPUT DELAY
00Sec

- » Press the arrow keys   to set the time of delay

0 Sec = no delay
(see note at the end of the chapter)

- » Confirm the selection with . The program jumps back to the main menu.

11.6.7 Upper level switch LS_{HIGH}



The pressure switch can be used to control the maximum level in the permeate vessel and stop production when this level is reached.

- » Select **6 HIGH LEVEL** in the main menu

6 HI LEVEL
7 MIN PRESSURE



6A HI LEVEL
ENABLED

- » Press the arrow keys   to select if relay input should be active or inactive.

ENABLED= active (ex works)

DISABLED = inactive

- » Confirm the selection with .

If the set point function has been activated, the program jumps to submenu "6B".

6B HI LEVEL
CONTACT N.O.



- » Press the arrow keys   to set the switching direction.

N.O. CONTACT = The input functions as a normally open contact.

N.C. CONTACT = The input works as a normally closed contact (**not recommended**)

- » Confirm the selection with . The program jumps to submenu "6C".

6C INPUT DELAY
00Sec

- » Press the arrow keys   to set the time of delay

0 Sec = no delay
(see note at the end of the chapter)

- » Confirm the selection with . The program jumps back to the main menu

11.6.8 Calibration low pressure switch PS_{Low}

With the help of a pressure switch between the feed water pre-filter and the high pressure pump the system inlet pressure can be monitored. If the pressure falls below a minimum pressure set on the pressure switch during production (e.g. due to a clogged pre-filter), production can be shut down and the system stopped.

7 MIN. PRESSURE
8 MAX. PRESSURE



7A LOW PRESSURE
ENABLED

- » Press the arrow keys to select if pressure switch should be active or inactive.
- » Confirm the selection with . The program jumps to submenu "7B".

7B LOW PRESSURE
CONTACT N.C.

By pressing the arrow keys you set switching direction.

N.O. CONTACT = The input functions as a normally open contact.

N.C. CONTACT = The input works as a normally closed contact

- » Confirm the selection with . The program jumps to submenu "7C"

NOTICE

N.C. contact is set ex works here. Do not change this! Otherwise there is a risk of damage to the system.

7C INPUT DELAY
00Sec

- » Press the arrow keys to set the time of delay

0 Sec = no delay
(see note at the end of the chapter)

- » Confirm the selection with . The program jumps to submenu "7D".

7D MAX RETRY
0

By pressing the arrow keys you set the number of start-up attempts (0-9).

- » Confirm the selection with . The program jumps to submenu "7E".

7E ALARM WASHING
YES

The menu item is not assigned.

Function of the startup repeats:

If the number of start-up repeats is set to "0", the unit stops as soon as the low-pressure monitor switches (and any delay time set has ended). All output relays are switched off! The display shows

SYSTEM STOPPED!
LOW PRESSURE

If the number of start-up repeats is set to e.g. "5", the unit stops as soon as the low-pressure monitor switches (and any delay time set has ended). The feed water valve SV1 stays activated. The display shows

**LOW PRESSURE!
ALARM 1/4**

If the minimum inlet pressure returns, the system starts up again automatically. If the system produces constantly for the next 10 minutes without any further disturbance, the repeat counter is reset to "0". If the pressure drops again, the system stops again and the counter is raised.

If the minimum inlet pressure does not return, the system will continue to start up within the next 20 minutes until the number of repetitions is reached. All output relays are now finally switched off! The display shows

**SYSTEM STOPPED!
NO PRESSURE**



**11.6.9 Calibration high pressure monitor (only WL-ROL/ WL-ROC140)
PS_{HIGH}**

The system operating pressure can be controlled by means of a pressure switch between the high pressure pump and the RO modules. If a maximum pressure set on the pressure switch is reached during production (e.g. due to an overly restricted concentrate valve), the system can be stopped.



**8 MAX PRESSURE
9 PUMP TEMP IN**



**8A HIGH PRESSURE
ENABLED**

- » Press the arrow keys   to select if pressure switch should be active or inactive.
- » Confirm the selection with . The program jumps to submenu "8B".

**8B HIGH PRESSURE
CONTACT N.C.**

- » Press the arrow keys   to set the switching direction.

N.O. CONTACT = The input functions as a normally open contact.



N.C. CONTACT = The input works as a normally closed contact

- » Confirm the selection with . The program jumps to submenu "8C".

NOTICE

N.C. contact is set ex works. Do not change this! Otherwise there is a risk of damage to the system.

8C INPUT DELAY
00Sec

- » Press the arrow keys   to set the time of delay

0 Sec = no delay
(see note at the end of the chapter)

- » Confirm the selection with . The program jumps back to the main menu.

Menu item 9: "High pressure pump TS_{HP}" is not active.

9 PUMP TEMP IN
10 SOFTENER

11.6.10 Upstream softening system IN_{FIL}



If the upstream softening system is e.g. equipped with an automatic backwashing device and has a potential-free switching contact to show the backwashing, then the control system can shut down the WL-ROC system for the duration of the filter backwashing and put it on hold.

It is also possible to connect an upstream 1-column softening system to the control so that the RO unit goes into standby mode for the duration of the regeneration.



10 SOFTENER
11 SPUELUNG

10A SOFTENER
ENABLED



- » Press the arrow keys   to select if relay input should be active or inactive.
- » Confirm the selection with . The program jumps to submenu "10B".
- »

10B SOFTENER
CONTACT N.O.



- » Press the arrow keys   to set the switching direction.

N.O. CONTACT = The input functions as a normally open contact.

N.C. CONTACT = The input works as a normally closed contact

- » Confirm the selection with . The program jumps to submenu "10C".

10C INPUT DELAY
00Sec

- » Press the arrow keys   to set the time of delay.

0 Sec = no delay
(see note at the end of the chapter)

- » Confirm the selection with . The program jumps back to the main menu

11.6.11 Module flushing

In this submenu you configure the module flush(es). Four flushing procedures can be programmed:

- At start-up of production
- During shutdown of the production
- During production at a programmed time interval
- In standby mode against standstill germination (same time interval as during production)

10 SOFTENER
11 CLEANING



11A WASHING
ENABLED

- » Press the arrow keys to select if relay input should be active or inactive.
- » Confirm the selection with . The program jumps to submenu "11B".

11B PUMP
YES

By pressing the arrow keys you set whether the high-pressure pump should run during flushing.

Yes = Pump ON

NO = Pump OFF

- » Confirm the selection with . The program jumps to submenu "11C"

11C EVIN
YES

Press the arrow keys to select, if a flush should be done when **production is started up**.

YES = active NO = inactive

- » Confirm the selection with . The program jumps to submenu "11D".

11D START PROD.
ENABLED

By pressing the arrow keys you set whether a flush should be carried out before each start.

- » Confirm the selection with . The program jumps to submenu "11E".

11E TIME
00min 00sec

By pressing the arrow keys you set the duration of the flushing time.

- » Confirm the selection with . The program jumps to submenu "11F".

11F END PROD.
ENABLED

By pressing the arrow keys you set whether a flush should be carried out at the end of the production.



- » Confirm the selection with . The program jumps to submenu "11G".

11G TIME
0min 15sec

By pressing the arrow keys you set the duration of the flushing time for the periodic module flushing.

- » Confirm the selection with . The program jumps to submenu "11H".

11H WASHCYCLE
0min 15sec 24h

By pressing the arrow keys   you specify the time period between the periodic module flushes.

e.g. change 24h to 48h (usage pause)

- » Confirm the selection with . The program jumps back to the main menu.



11.6.12 Configuration of the alarm - output relay

(See 11.7 wiring diagram)



12 ALARM
13 RESET



12A ALARM
ENABLED

- » Press the arrow keys   to turn the alarm output on or off.
- » Confirm the selection with . The program jumps to submenu "12B".

12B OUTPUT ALARM
CONTACT N.C.

- » Press the arrow keys   to set the switching direction.

N.O. CONTACT = The input functions as a normally open contact.

N.C. CONTACT = The input works as a normally closed contact.

- » Confirm the selection with . The program jumps back to the main menu.

11.6.13 Operating and service hour counter

The operating hours counter always runs when the system is in production mode. It is for general information and has no further control function.



It counts down the time. As soon as the counter has reached "0 hours", the following message appears on the display: "EXECUTE MAINTENANCE" (do maintenance).

The counter is set in the " 18 MAINTENANCE" submenu.



13 RESET
14 SYSTEM TEST



13A RES HR COUNT
ENTER = YES



- » Press the arrow keys   to select, if the operation counter should be reset.
- » Confirm the selection with . The program jumps to submenu "13B".

13B RES SERVICE
ENTER = YES

By pressing the arrow keys   you select if the service interval should be reseted.

- » Confirm the selection with . The program jumps back to the main menu.

Resetting the parameters to factory settings (except password)::



- » Switch off the system
- » Press and hold  and  and switch on the system. Only then release the buttons.

RESET Passwort:

- » Switch off the system
- » Press and hold  and ESC and switch on the system. Only then release the buttons.

- » Press the key again to switch the relay back.
- » Press ESC  to return to the main menu

NOTICE

To avoid damage to the unit: Always activate the feed water valve  first before activating the pump .

11.6.14 Function test relay outputs

In this submenu you can check the relay outputs.

13 RESET
14 SYSTEM TEST







AU=ROHW L=SPUL
AB=PERM R=PUMPE

Display changes automatically

ENTER=DOS. PUMPE
ESC=TEST EXIT

- » Press the keys described below to switch the relay.

UP 	Feed water valve
DN 	Permeate flush valve V _{PER}
L 	Concentrate-flush valve V _{CONC}
R 	High pressure pump H _p
E 	Dosingpump Antiscalant P _{ASC}



11.6.15 Function test alarm output relay

In this submenu you can manually activate the alarm output. The switched-on relay is then reset to its switching status as programmed in submenu 12.

15 ALARM TEST
16 LANGUAGE



UP=ALARM
ESC=TEST EXIT

- » Press "UP" , to switch the relay.
- » Press the key again to switch the relay bac
- » Press ESC  to return to the main menu

11.6.16 Select language

In this submenu you can select the language shown on the display.

16 LANGUAGE
17 SET PASSWORD



LANGUAGE
ENGLISH

- » Press the arrow keys to select your language
- » Confirm the selection with . The program jumps back to the main menu

11.6.17 Change password

In this submenu you can change the password to program the main menu.

17 SET PASSWORD
18 MAINTENANCE



OLD PASSWORD
0000

- » Press the arrow keys to enter your latest password
- » Confirm the selection with .

If the entry is correct, the program displays "PASSWORD ACCEPTED" and jumps to the next submenu.

NEW PASSWORD
0000

- » Press the arrow keys to enter your new password
- » Confirm the selection with . The program jumps to the screen:

CONFIRM
0000

- Press the arrow keys to enter your new password again.
- » Confirm the selection with . The program jumps to the screen:

PASSWORD
CHANGED

If the entry is incorrect, "CONFIRM ERROR" appears on the display for approx. 2 seconds before the programme jumps back to the "NEW PASSWORD" input display so that the new password can be entered again.

11.6.18 Reset password

To reset the password follow the steps below:

- » disconnect the unit from the power supply
- » press the two buttons while reconnecting the plug (connect to power supply).

The display will show "RESET PASSWORD" for a few seconds before the pump is started up.

11.6.19 Setting the maintenance interval

In this submenu you activate the service interval and enter the countdown of the service hour counter. In the delivery status, the service hour counter is set to 00100 hours. (100 hours). Resetting the countdown is described in submenu 13.

18 MAINTENANCE
19 DOSING PUMP



18A MESSAGE ENABLED

- » Press the arrow keys to activate or inactivate the service hour counter
- » Confirm the selection with . The program jumps to submenu "18B".

18B RANGE
xxx Hr

Press the arrow keys to enter the Serviceintervall in hours

- » Confirm the selection with . The program jumps back to the main menu.

11.6.20 Dosing pump antiscalant IN_{PASC}

If a dosing pump for the dosing of antiscalant is installed instead of an upstream softening system, then either the potential-free fault signal output of the dosing pump or the level switch (empty indicator) in the dosing vessel can be connected to the controller.

If the INPASC input is switched, the control system can switch off the RO system for the duration of the fault and put it in the waiting mode. As soon as the fault has been eliminated, the control system automatically returns the RO system to production mode.

19 DOSING PUMP
20 STAND BY/ INPUT



19A FAILED DO. ENABLED

- » Press the arrow keys to select if relay input should be active or inactive.
- » Confirm the selection with . The program jumps to submenu "19B".
- »

19B FAILED DO. CONTACT N.C.



- » Press the arrow keys to set the switching direction.

N.O. CONTACT = The input functions as a normally open contact.

N.C. CONTACT = The input works as a normally closed contact

- » Confirm the selection with . The program jumps to submenu "19C".

19C INPUT DELAY
00Sec



- » Press the arrow keys   to set time of delay.
- » Confirm the selection with . The program jumps back to the main menu.

11.6.21 Stand-by-Input IN_{SB} (Release contact)



20 STAND BY / INPUT
21 PUMP DELAY



20A STAND BY IN
ENABLED

- » Press the arrow keys   to select if relay input should be active or inactive.
- » Confirm the selection with . The program jumps to submenu "20B".

20B STAND BY IN
CONTACT N.O.



- » Press the arrow keys   to set the switching direction.

N.O. CONTACT = The input functions as a normally open contact.

N.C. CONTACT = The input works as a normally closed contact

- » Confirm the selection with . The program jumps to submenu "20C".

20C INPUT DELAY
00Sec

- » Press the arrow keys   to set the time of delay

0 Sec = no delay
(see note at the end of the chapter)

- » Confirm the selection with . The program jumps back to the main menu.

11.6.22 Set start delay

20 STAND BY/ INPUT
21 PUMP DELAY



21A PUMP DELAY
00 sec

NOTICE

Output activation / delay:

In order to avoid pipeline damage due to "water hammer", a delay of 3 seconds between pump on (or off) and solenoid valve on (or off) and a delay of 2 seconds between pump on (or off) and pressure pump on (or off) has been set at the factory.

11.7 Wiring diagram

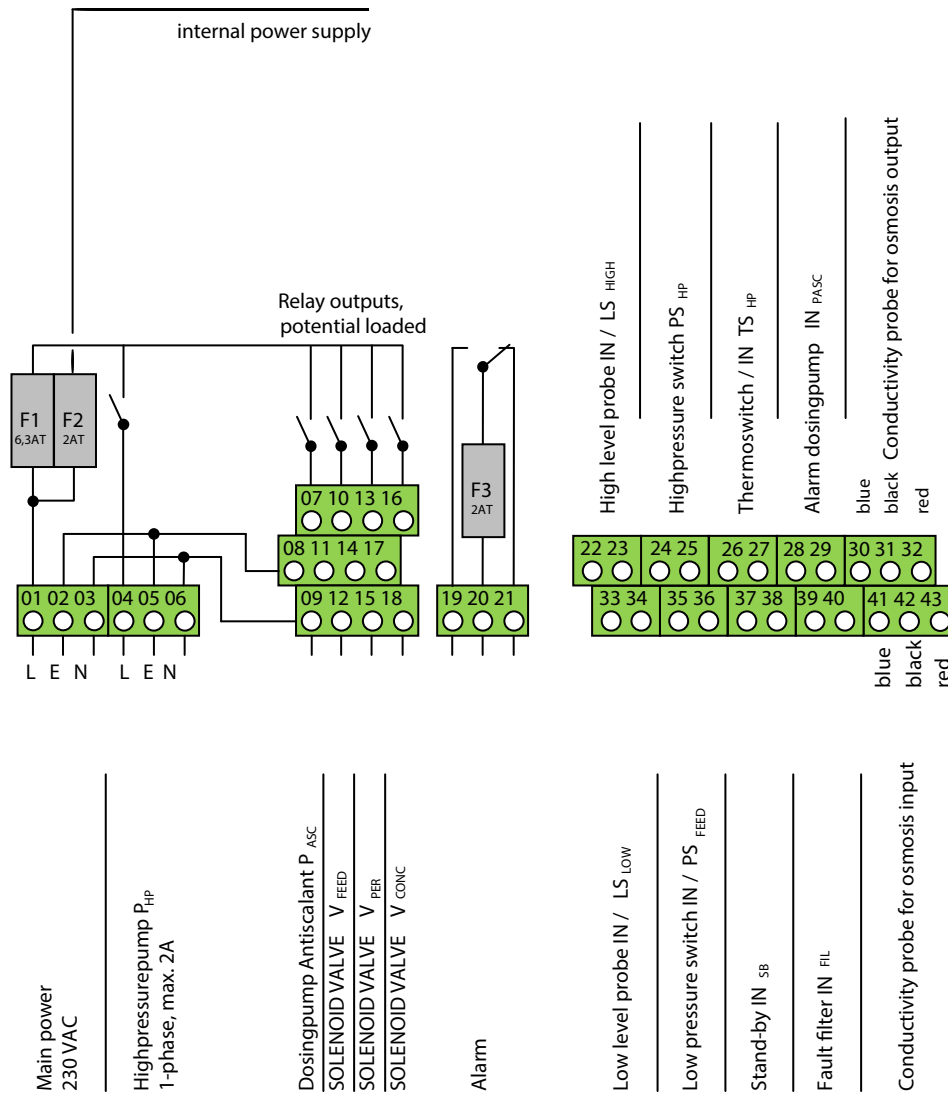

Power supply, output relay			
01	02	03	Main power IN 230 VAC
L	E	N	
04	05	06	Highpressurepump IN / P _{HP} 1-phase, max. 2A
L	E	N	

19	20	21	Alarm OUT
N.O.	C	N.C.	

E:

Output relay			
07	08	09	Dosingpump Antiscalant OUT/ P _{ASC}
L	E	N	
10	11	12	SOLENOID VALVE (EV IN) / V _{FEED}
L	E	N	
13	14	15	SOLENOID VALVE (EV OUT) / V _{PER}
L	E	N	
16	17	18	SOLENOID VALVE (EV Conc) / V _{CONC}
L	E	N	

Digital inputs	
22	High level probe IN / LS _{HIGH}
23	
24	Highpressure switch IN / PS _{HP}
25	
26	Thermoswitch IN (pressure pump motor) / TS _{HP}
27	
28	Alarm dosingpump IN _{PASC}
29	

Digital inputs	
33	Low level probe IN / LS _{LOW}
34	
35	Low pressure switch IN / PS _{FEED}
36	
37	Stand-By IN _{SB}
38	
39	Filter IN _{FIL}
40	

Conductivity measurement option 1			Conductivity measurement option 2		
30	blue	Conductivity probe for osmosis output ECDI/01 0,0 – 99,9 µS/cm	41	blue	Conductivity probe for RAW/MIX water ECDI/1 0,0 – 999,9 µS/cm
31	black		42	black	
32	red		43	red	

12. Error description

If an error appears, the permeate production stops. The display in the control panel switches from the current display to the display of an error code.

List of possible faults and error codes

Alarm indication on the display	Possible cause	Action
ALARM - CONDUCTIVITY	The conductivity measuring instrument has lost calibration or is no longer working correctly.	Recalibrate or replace the conductivity sensor.
	The feed water parameters have changed.	Contact your supplier or the manufacturer.
	High permeate conductivity due to blocked membrane(s).	Replace the membrane(s).
	Piping blocked	Eliminate the cause of the blockage.
	Delay time too short	If the error occurs after a module flush, change the delay time in parameter 3D. If the error occurs during production, adjust parameter 4C.
	Conductivity limit value chosen too low	Check the conductivity limit value entered. Adjust if it's necessary. Note the technical data of the consumer / humidifier.
SYSTEM STOP - HIGH PRESSURE The PSHIGH overpressure switch for the max. permissible operating pressure has switched. Only for WL-ROC 140 and WL-ROL units	The PS _{HIGH} pressure switch is not calibrated or is not working correctly.	Replace the pressure switch.
	Water pressure too high.	Re-adjust the pump pressure.
	Membrane(s) is/are blocked.	Replace membrane.
SYSTEM STOP - NO PRESSURE The PS _{LOW} overpressure switch for the min. permissible operating pressure has switched.	The PS _{LOW} pressure switch is not calibrated or is not working correctly.	Check an existing pre-treatment (if any). Replace the pressure switch.
	Decreasing flow rate. Blocking of filter cartridges..	Replace them.
	Water pressure too low.	Check the function of the solenoid valve. Check the water inlet pressure.
System STOP - DOS PUMP (only for systems with dosing pump)	Dosing pump does not work.	Check the fuse and replace it if necessary .
		Dosing pump is not working, replace it.
	Dosing pump does not work, the magnet "knocks".	The suction filter in the anti-coating canister is blocked. Clean the filter.
	Dosing pump does not work, the magnet does not "knock" or only damped.	Dirt deposits in the valve or valve is blocked. Replace the dosing pump.
	The red LED in the display of the dosing pump lights up.	Level alarm. Refill with anti-calant.

List of possible faults and error codes (sequel)

Problem	Possible cause	Action
Reduction of the permeate rate.	Decrease of permeator inlet pressure	Check pump P, make sure it is running correctly, replace it if necessary.
		Readjust the pressure to the sizing values and adjust the bypass inside pump P if necessary.
	Increase the pressure loss at the membrane due to blockages caused by hardness minerals	Check the process parameters and contact the supplier to arrange for replacement of the membrane(s) if necessary.
	The pressure switches have lost calibration, are worn or no longer function correctly.	Adjust or reset the flow rate and pressure to match the process values.
		Check the electrical connections.
	Blocked piping.	Correct the cause.
	Reduction of the water flow rate.	If necessary, check the water supply or adjust the shut-off valves in front of the system.
Filter cartridges blocked. Replace the filter elements.		
The parameters of the water entering the system have changed.	Contact your supplier or the manufacturer.	
Immediate stop (within one minute after start-up).	The pressure switches installed on the PVC distributor of the permeate are not working correctly or are not calibrated.	Check the function of the pressure switches and replace them if necessary.
	Inlet pressure of the expansion vessel is too low. Membrane of the expansion vessel is damaged.	Check the inlet pressure of the expansion tank and replace it if it is damaged.
The solenoid valves do not open	Control board or the solenoid valve coil is not supplied with voltage.	Restore the power supply to the control board and/or check the connections and the solenoid valve supply.
	Solenoid valve is defective.	Replace the solenoid valve.
	Incorrect pressure.	Check the water inlet pressure.
	Process parameters not correct.	Check the parameter settings.
High permeate conductivity	The membrane(s) is/are blocked or contaminated.	Replace the membrane(s). Contact your supplier or the manufacturer.
Low water pressure	Low water pressure Inlet valves closed	Check the water inlet pressure.
		Check the function of the solenoid valve.
	Decreasing flow rate	Blocked filter cartridges. Replace them.
The osmosis production does not start although it is activated and no alarm has been given.	The pressure switches doesn't supply a signal.	Check the connections and the function of the pressure switches and replace them if necessary.
	The fuse that protects the pump is blown.	Replace the fuse and test pump operation.
The system does not carry out the set sequences.	Power supply failure.	Check the power supply.

13. Declaration of Conformity

The manufacturer **ATLAS FILTRI ITALIA s.r.l. - Via Unità d'Italia 12 – 35010 Limena (PD) Italy**

hereby declares that the products:

Code NEA0550051 – Reverse Osmosis system 25 l/h – WL-ROC-25
 Code NEA0550052 – Reverse Osmosis system 40 l/h – WL-ROC-40
 Code NEA0550053 – Reverse Osmosis system 80 l/h – WL-ROC-80
 Code NEA0550054 – Reverse Osmosis system 140 l/h – WL-ROC-140

Code NEA0550055 – Reverse Osmosis system 160 l/h with Antiscalant – WL-ROL-160AS
 Code NEA0550056 – Reverse Osmosis system 320 l/h with Antiscalant – WL-ROL-320AS
 Code NEA0550057 – Reverse Osmosis system 460 l/h with Antiscalant – WL-ROL-460AS
 Code NEA0550058 – Reverse Osmosis system 600 l/h with Antiscalant – WL-ROL-600AS
 Code NEA0550059 – Reverse Osmosis system 1000 l/h with Antiscalant – WL-ROL-1000AS
 Code NEA0550060 – Reverse Osmosis system 1200 l/h with Antiscalant – WL-ROL-1200AS

Code NEA0550065 – Nano Filtration system 160 l/h with Antiscalant – WL-ROL-160NF
 Code NEA0550066 – Nano Filtration system 320 l/h with Antiscalant – WL-ROL-320NF
 Code NEA0550067 – Nano Filtration system 460 l/h with Antiscalant – WL-ROL-460NF
 Code NEA0550068 – Nano Filtration system 600 l/h with Antiscalant – WL-ROL-600NF
 Code NEA0550069 – Nano Filtration system 1000 l/h with Antiscalant – WL-ROL-1000NF
 Code NEA0550070 – Nano Filtration system 1200 l/h with Antiscalant – WL-ROL-1200NF

Code NEA0550071 – Reverse Osmosis system 160 l/h – WL-ROL-160
 Code NEA0550072 – Reverse Osmosis system 320 l/h – WL-ROL-320
 Code NEA0550073 – Reverse Osmosis system 460 l/h – WL-ROL-460
 Code NEA0550074 – Reverse Osmosis system 600 l/h – WL-ROL-600
 Code NEA0550075 – Reverse Osmosis system 1000 l/h – WL-ROL-1000
 Code NEA0550076 – Reverse Osmosis system 1200 l/h – WL-ROL-1200

have been designed and built in conformity with the following directives:

LOW VOLTAGE	2014/35/EC
ELECTROMAGNETIC COMPATIBILITY	2014/30/EC

The following standards have been consulted to check the conformity:

EN IEC-61000-6-2 - Electromagnetic compatibility (EMC) - Part 6-2: Generic standards - Immunity for industrial environments

EN IEC-61000-6-3 - Electromagnetic compatibility (EMC) - Part 6-3: Generic standards - Emission standard for residential, commercial and light-industrial environments

ATLAS FILTRI ITALIA SRL - Unipersonale

Sede Legale ed Operativa
 Via Unità d'Italia, 12 - 35010 LIMENA (PD)
 C.F. e P.I. 03212000289
 Cap. Soc. € 34.000,00 - REA n° 292223
 Telefono +39 0498629133 - Fax +39 0498845294
 atlasitalia@atlasfiltri.com - www.atlasfiltri.com

ASSOCIATA _____



EN 61000-3-2 - Electromagnetic compatibility (EMC) - Part 3-2: Limits - Limits for harmonic current emissions (equipment input current ≤ 16 A per phase)

EN 61000-3-3 - Electromagnetic compatibility (EMC) - Part 3-3: Limits - Limitation of voltage changes, voltage fluctuations and flicker in public low-voltage supply systems, for equipment with rated current ≤ 16 A per phase and not subject to conditional connection

EN60335-1 - Household and similar electrical appliances - Safety - Part 1: General requirements

EN60335-2-41 - Household and similar electrical appliances - SafetyPart 2: Particular requirements for pumps

EN62233 - Measurement methods for Electromagnetic fields of household appliances and similar apparatus with regard EN 62233/AC 2008-08 to human exposure

Limena (PD), November 2020

ATLAS FILTRI ITALIA srl

ATLAS FILTRI ITALIA SRL
Via Unità d'Italia, 12 - 35010 Limena (PD)
Cod. Fisc. e P. IVA 03212000289
Tel. 049 8629133 - Tel. 049 8841410

ATLAS FILTRI ITALIA SRL - Unipersonale

Sede Legale ed Operativa

Via Unità d'Italia, 12 - 35010 LIMENA (PD)
C.F. e P.I. 03212000289
Cap. Soc. € 34.000,00 - REA n° 292223
Telefono +39 0498629133 - Fax +39 0498845294
atlasitalia@atlasfiltri.com - www.atlasfiltri.com

ASSOCIATA _____

AQUA40ITALIA
ASSOCIAZIONE COSTRUTTORI TRATTAMENTI ACQUE PRIMARIE

FEDERATA
ANIMA
CONFINDUSTRIA
MECCANICA VARIA

14. Spare parts

WL-ROL	WL-ROC	Article. No.	Type	Description
	x	AUC0180000	Spare	Expansion vessel white 18L 3/4" M
	x	AUC0400000	Spare	Expansion vessel white 40L 3/4" M
x		AUC080K000	Spare	Expansion vessel white 80L 3/4" M
x		AUC100K000	Spare	Expansion vessel white 100L 3/4" M
x		AUC200K000	Spare	Expansion vessel white 200L 3/4" M
x		AUC300K000	Spare	Expansion vessel white 300L 3/4" M
x		AUC500K000	Spare	Expansion vessel white 500L 3/4" M
x		AUCK00BR34	Spare	Wall mouting bracket SS/painted 3/4" F-F for 18L or 40L expansion vessel
	x	ROKC00CV18	Spare	Check valve push-in 1/8"-compression fitting for tube Ø1/4" x 1/8" M
	x	ROKC00CV10	Spare	Check valve push-in 10/10 black acetal
x		ROKC00CV20	Spare	Check valve in PVC ø20mm
x		AUCK00PF15	Acc	Expansion vessel connection kit PVC 3/4" M - JG15
x		WF-50-00005	Acc	Expansion vessel connection kit stainless steel 3/4" (only for WL-ROL-1000/1200)
x		AUCK00MABV	Acc	Stainless steel fitting with pressure gauge and tap for connection to the top of the expansion vessel 100-500 L
	x	ROKC00DEBA	Acc	UV disinfection system 240 l/h max. JG10
	x	ROKC00UVLA	Spare	UV lamp for ROKC00DEBA
	x	ROKC00QZLA	Spare	Quartz for UV lamp 240 LPH
x		ROKC00DEB1	Acc	UV disinfection system 680 l/h max. JG15
x		ROKL00UVL1	Spare	UV lamp for ROKL00DEB1 (ROL100 - ROL600)
x		ROKL00QZL1	Spare	Quartz for UV lamp 680 LPH
x		ROKC00DEB2	Acc	UV disinfection system 1360 l/h max. 3/4"
x		ROKL00UVL2	Spare	UV lamp for ROKL00DEB2 (ROL1K0-ROL1K2)
x		ROKL00QZL2	Spare	Quartz for UV lamp 1360 LPH
	x	ROKC00UVOR	Spare	Quartz lamp O RING silicone for quartz lamp
x	x	ROKL00UVT1	Spare	Electronic ballast 230V 50-60HZ for lamp 10-21 W
	x	ROKC00BLD1	Acc	Blending kit for WL-ROC 25-80l/h with adjustable mixing ratio and conductivity sensor
	x	ROKC00BLD2	Acc	Blending kit for WL-ROC 140l/h with adjustable mixing ratio and conductivity sensor
x		ROKL00EC02	Acc	Kit inlet conductivity probe 1/2".
	x	ROKC00DPK1	Acc	Kit antiscalant for ROC140 with VCL200110000 pump,5 Bar injection valve, tank and fittings
	x	ROKC00DP01	Spare	Anti scalant metering pump VCL200110000. 1 l/h at 20 Bar. 230Vac Schuko
x		ROKL00DP00	Spare	Anti scalant metering pump VCL150210001. 2 l/h at 15 Bar. 230Vac Schuko
x	x	ROKL00JV00	Spare	Injection valve 5 Bar
x	x	ROKL00AT00	Spare	20L tank with cap
x	x	ROKL00DPPI	Spare	Connection hoses kit for metering pump, injection valve and 20l tank
x	x	ROKL00AS10	Spare	Antiscalant Pragmaclean 309, EN 15040 compliant for DACH. 10Liter
x	x	ROKL00AS25	Spare	Antiscalant Pragmaclean 309, EN 15040 compliant for DACH. 25Liter
	x	ROKC00FR02	Spare	Kit flow restrictors ROC25
	x	ROKC00FR04	Spare	Kit flow restrictors ROC40
	x	ROKC00FR08	Spare	Kit flow restrictors ROC80
	x	ROKC00FR14	Spare	Kit flow restrictors ROC140
x	x	ROKC00KIT1	KIT	Connection to Humisonic when distance <= 3m, or additional humidifiers (double cylinder).
x	x	ROKC00KIT2	KIT	Connection to Humisonic humidifiers when 3m < distance <=20m or additional humidifiers (double cylinder).
x	x	ROKC00KIT4	KIT	Connection to Isothermal when distance <= 3m, or additional humidifiers (double cylinder)
x	x	ROKC00KIT5	KIT	Connection to Isothermal humidifiers when 3m < distance <=20m or additional humidifiers (double cylinder)
x	x	ROKC00KIT3	KIT	Connection to optiMist / humiFog / chillBooster / MC. To be used with KIT1 or KIT2
	x	ROKC001810	Spare	Quick coupling brass straight, Ø10x 1/8" cylindrical for connecting WL-ROC to humidifier

WL-ROL	WL-ROC	Article. No.	Type	Description
	x	E-5000120	Spare	LLPDE hoose white 10/7
	x	E-7600224	Spare	LLPDE hoose black 10/7 (only WL-ROC-140)
	x	E-7600186	Spare	LLPDE hoose black 10/7 (only WL-ROC-25-80)
x		E-7600264	Spare	LLPDE hoose white 15/11,5
x		E-7600262	Spare	LLPDE hoose black 1/711,5
x	x	ROKC003410	Spare	Adapter acetal 3/4" F - JG10 with flat inner gasket
x	x	ROKL003415	Spare	Adapter acetal 3/4" F - JG15 with flat inner gasket
	x	ROK00TEE1	Spare	Equal TEE black acetal 3x JG10
	x	ROKC00Y001	Spare	Y connection Ø10
	x	ROKC00VALS	Spare	Hand valve union connector JG10 F-F
x		ROKC00KY15	Spare	Y-Piece 15mm (with 2x reducers 10mm)
x	x	ROKL00EC01	Spare	Conductivity probe ECPROB OUT
x	x	E-5000134	Spare	LDOSIN control, Hygromatik branded
x	x	ROKL00PSHP	Spare	Pressure switch PSHIGH 12 bar; NC; 1/4" M brass - with plastic protective cups IP65
x	x	ROKL00PSHL	Spare	Pressure switch PSMAX 4 bar; NC; 1/4" M brass - with plastic protective cups IP65
x	x	ROKL00PSLL	Spare	Pressure switch PSMIN 2 bar; NC; 1/4" M brass - with plastic protective cups IP65
	x	ROKC00MA06	Spare	Pressure guage 6 Bar; SS case; 40mm diameter; Brass 1/8"G Back; glycerine filled
	x	ROKC00MA16	Spare	Pressure guage 16 Bar; SS case; 40mm diameter; Brass 1/8"G Back; glycerine filled
	x	ROKC00MR16	Spare	Pressure guage 16 Bar; SS case; 40mm diameter; Brass 1/8"G Radial; glycerine filled
x		ROKL00MA06	Spare	Pressure guage 6 Bar; SS case; 63 mm diameter; Brass 1/4"G Radial, glycerine filled
x		ROKL00MA16	Spare	Pressure guage 16 Bar; SS case; 63 mm diameter; Brass 1/4"G Back, glycerine filled
	x	ROKC00VALN	Spare	Permeate check valve CV3 - diam. 6 mm
	x	ROKC00FLT1	Spare	Carbon block cartridge filter CB-EC 10" SX 5µm
	x	ROKC00HOU1	Spare	Water inlet filter housing 10"; 1/2" GF
x	x	ROKC00WREN	Spare	Spanner for 10" filter DP model
x	x	ROKC00FLT2	Spare	Carbon block cartridge filter CB-EC 10" SX 10µm
x	x	ROKC00FLT3	Spare	Sediment melt-blown filter CPP 10" SX 5µm
x	x	ROKC00OR10	Spare	10" water inlet filter gasket kit
x	x	ROKC00HOU5	Spare	Water inlet filter housing 10" double; 3/4" GF
x		ROKL00FLT5	Spare	Carbon block cartridge filter CB-EC 20" SX 10µm
x		ROKL00FLT4	Spare	Sediment melt-blown filter CPP 20" SX 5µm
x		ROKL00OR20	Spare	20" water inlet filter gasket kit
x		ROKL00HOU2	Spare	Water inlet filter housing 20" double; 3/4" GF
x		ROKL00WREN	Spare	Spanner for 20" filter 3P MODEL
	x	ROKC00MEMB	Spare	RO membrane 2012LP
	x	ROKC00VESS	Spare	Membrane vessel 2012
	x	ROKC00ME00	Spare	RO membrane 2012-400
	x	ROKC00SPAN	Spare	Spanner for 2 inch membrane vessel
	x	ROKC00ME14	Spare	RO membrane 4021XL
	x	ROKC00VESM	Spare	Membrane vessel 4021
x		ROKL00OR25	Spare	O-ring for 2.5" RO membrane and membrane cylinder
x		ROKL00OR40	Spare	O-ring for 4" RO membrane and membrane cylinder
x		ROKL00ME10	Spare	RO membrane LOW4-2540
x		ROKL00VS25	Spare	Membrane vessel 2540
x		ROKL00EXMB	Spare	Extraction kit for membrane vessels
x		ROKL00ME20	Spare	RO membrane LOW4-4040
x		ROKL00VS40	Spare	Membrane vessel 4040
x		ROKL00ME30	Spare	RO membrane LOW4 4040XL
	x	ROKC00MOT5	Spare	Motor 245W 50Hz
x	x	ROKL00MOT5	Spare	Motor 550W 50Hz
x	x	ROKL00AD00	Spare	Adapter M80
x	x	ROKL00EJ00	Spare	Coupling for motor 550W
x		ROKL00PU32	Spare	Pump with bypass 800 lph for ROL 320
	x	ROKC00PUMP	Spare	Pump with bypass 150 lph for ROC25-40
	x	ROKC00PU00	Spare	Pump with bypass 300 lph for ROC80
	x	ROKC00PU14	Spare	Pump with bypass 1000 lph for ROC140
x		ROKL00PUMP	Spare	Pump with bypass 800 lph for ROL 160-320
x		ROKL00PUM5	Spare	Multistage centrifugal pump 3SV14F015M for ROL460-ROL600-ROL1000
x		ROKL00PUX5	Spare	Multistage centrifugal pump 3SV16F015M for ROL1200

WL-ROL	WL-ROC	Article. No.	Type	Description
x	x	ROKL00IV12	Spare	SOLENOID VALVE SV1 1/2" G F 230Vac (ELETTROVALVOLA + BOBINA)
x		ROKL00IV34	Spare	SOLENOID VALVE SV1 3/4" G F 230Vac (ELETTROVALVOLA + BOBINA)
x	x	ROKL00IV14	Spare	SOLENOID VALVE SV2 1/4" G F 230Vac (ELETTROVALVOLA + BOBINA)
	x	ROKC00P064	Spare	PE PIPE Ø6/4
x		ROKL00FL20	Spare	Flow meter D.20 - 320 lph
x		ROKL00FL25	Spare	Flow meter D.25 1000 lph
x		ROKL00FL32	Spare	Flow meter D.32 - 1600 lph
x		ROKL00PVCA	Spare	PVC fittings for antiscalant injection (ROL100÷ROL320)
x		ROKL00PVCB	Spare	PVC fittings for water inlet conductivity meter (ROL100÷ROL320)
x	x	ROKL00FC40	Spare	Cable L = 4 m and connector for ROL conductivity probe with common mode filter
x	x	ROKL00FC15	Spare	Cable L = 1.5 m and connector for ROL conductivity probe with common mode filter
x	x	ROKL00CP02	Spare	Conductivity probe 1/2" K=1 0-999uS
x	x	ROKL00CP01	Spare	Conductivity probe 1/2" K=0,1 0,0...99,9uS

For ordering spare parts, a template can be found on the www.hygromatik.com website under the „Contact“ tab. Your spare parts order may as well be directed per e-mail to the HygroMatik main office using the address hy@hygromatik.de.

Please make sure to specify your unit model and serial number.

15. Commissioning report / maintenance documentation

Commissioning report for HygroMatik reverse osmosis systems WL-ROC-XX and WL-ROL-XX			
Unit	Type _____	Serial number _____	
	Type of pressure expansion vessel _____		
	Date of maintenance _____		
	Company / name _____		
Customer	Commercial / Private _____		
	Street / Number _____		
	Postal code / City _____		
	Contact on site _____	Telephone number _____	
		checked / Value	Remarks
Unit condition	Unit delivered complete?	<input type="checkbox"/> yes <input type="checkbox"/> no	
	Transport locks removed?	<input type="checkbox"/> yes <input type="checkbox"/> no	
	All hoses and connections checked for damage?	<input type="checkbox"/> yes <input type="checkbox"/> no	
	All detachable PVC screw connections tightened? (WL-ROL-XX only)	<input type="checkbox"/> yes <input type="checkbox"/> no	
	All electrical cables checked for external damage?	<input type="checkbox"/> yes <input type="checkbox"/> no	
General	Distance appliance - pressure expansion vessel _____	meters	
	Distance pressure expansion vessel - consumer _____	meters	
	Connection to the drinking water system	<input type="checkbox"/> yes <input type="checkbox"/> no	
	Softening system connected?	<input type="checkbox"/> yes <input type="checkbox"/> no	
	Hoses to the anti-scalant pump and canister connected (if available)?	<input type="checkbox"/> yes <input type="checkbox"/> no	
	Prefilter and membranes in position?	<input type="checkbox"/> yes <input type="checkbox"/> no	
Feed water	Total hardness _____	°dH	
	Conductivity _____	µS/cm	
	Temperature _____	°C	
	Water inlet pressure _____	bar	
Permeate / Konzentrate	Conductivity permeate _____	µS/cm	
	Conductivity concentrate _____	µS/cm	
	Conductivity Mixwater (only WL-ROC-XX with blending kit) _____	µS/cm	
	Operation pressure _____	bar	
	Permeate quantity _____	l/h	
	Concentrate quantity _____	l/h	
	Demineralisation rate _____	%	
	Switch-on pressure _____	bar	
	Switch-off pressure _____	bar	
	Antiscalant dosing (if available) activated according to operating instructions and canister filled to mixing ratio?	<input type="checkbox"/> yes <input type="checkbox"/> no	
<p>Note: The commissioning values are to be documented as a basis for the system assessment. A water analysis is to be attached to this protocol.</p>			
<p>Datum / Unterschrift _____</p>			

Maintenance checklist for HygroMatik reverse osmosis systems WL-ROC-XX and WL-ROL-XX

Unit	Type	Serial number
	Type of pressure expansion vessel	
	Date of maintenance	
	Company / name	
Customer	Commercial / Private	
	Street / Number	
	Postal code / City	
	Contact on site	Telephone number

The following system components were tested (settings, setpoints, levels, etc.):	Error-free operation		Replacement		Remarks
	Yes	No	Yes	No	
Activated carbon pre-filter	<input type="checkbox"/>	<input type="checkbox"/>	<input type="checkbox"/>	<input type="checkbox"/>	
5 µm-prefilter (only for WL-ROL, WL-ROC140)	<input type="checkbox"/>	<input type="checkbox"/>	<input type="checkbox"/>	<input type="checkbox"/>	
membrane(s)	<input type="checkbox"/>	<input type="checkbox"/>	<input type="checkbox"/>	<input type="checkbox"/>	
electrical connections	<input type="checkbox"/>	<input type="checkbox"/>	<input type="checkbox"/>	<input type="checkbox"/>	
Dosing pump (if available)	<input type="checkbox"/>	<input type="checkbox"/>	<input type="checkbox"/>	<input type="checkbox"/>	
Tightness of the unit	<input type="checkbox"/>	<input type="checkbox"/>	<input type="checkbox"/>	<input type="checkbox"/>	
UV lamp (replace after 9000 hours or 1 year) if available	<input type="checkbox"/>	<input type="checkbox"/>	<input type="checkbox"/>	<input type="checkbox"/>	
Control	<input type="checkbox"/>	<input type="checkbox"/>	<input type="checkbox"/>	<input type="checkbox"/>	

Measured parameters		Values at		Remarks
		Commissioning	Maintenance	
Operating hours	hours			
Feed water pressure	bar			
Water pressure behind pre filter	bar			
Total hardness feed water	°dH			
Conductivity feed water	µs/cm			
Temperature feed water	°C			
Conductivity permeate	µs/cm			
Conductivity mixed water (only WL-ROC-XX with blending option)	µs/cm			
Operation pressure	bar			
switch-on pressure (max 2 bar)	bar			
switch-off pressure (max 4 bar)	bar			
Permeate quantity in relation to the feed water quantity used		☺	☹	
Concentrate quantity in relation to the feed water quantity used		☺	☹	
Reset service counter		☺	☹	

Samples taken for analysis			Remarks
Feed water	<input type="checkbox"/>		
Permeate	<input type="checkbox"/>		

NOTE: The commissioning values are to be documented as a basis for the system assessment. Copy this form for multiple use.

Date / Sign _____

16. Technical specifications

Technical Data WL-ROC (Reverse Osmosis Compact)				
	WL-ROC 25	WL-ROC 40	WL-ROC 80	WL-ROC 140
permeate production [l/h] * (+/- 10%)	25	40	80	140
concentrate production [l/h]*	25	40	80	140
water consumption during operation [l/h]	50	80	160	280
max. output Permeate [%]	50			
membran pressure [bar]	8	8	5	10
feed water pressure [bar]	2 - 5			
water pressure permeate max. [bar]	4			
feed water temperature [°C]	5 - 25			
Water hardness	20 °dH without pre-treatment (otherwise: softening)			
feed water Total Dissolved Salt [ppm]	< 750			
feed water conductivity [µS/cm]	< 1000			
number of membranes	1	2	2	1
electrical connection	230V /1Ph /N /50-60Hz			
electrical power [kW]	0,3			0,6
operation weight (kg)	19	21	21	41
Dimensions [mm]	width	420		770
	height	580		700
	depth	235		220
permeate pipe connection	John Guest 10 mm			
water connection	3/4" external thread			
drainage connection	John Guest Ø 8 mm			John Guest Ø12 mm
drain function	/			✓
Conductivity measurement	Permeate monitoring and alarm function included			
Antiscalant pump	/			optional
Adjustable blending for ELDB	optional available			

* Specifications refer to the reference water quality: 15°C, TDS: 250 ppm, free of iron and chloride

These values are theoretical because they can change with the temperature of the feed water and its chemical and physical qualities. These values were used for feed water with a TDS of 250 ppm and a water temperature of 16°C.

The temperature of the feed water has a great influence on the productivity and quality of the permeate. As the temperature increases, the permeate output also increases, but with a worse conductivity value.

The recovery value is calculated as follows:

$$\text{RECOVERY (\%)} = \frac{\text{Permeate}^*}{\text{Permeate}^* + \text{Concentrate}^*} \times 100$$

* quantity

These options are available:

- Retrofit antiscalant WL-ROC-140
- Retrofit kit blending WL-ROC-140
- UV-lamp for WL-ROC-140
- Retrofit kit blending WL-ROC-25 to 80
- expansion vessel

17. Antiscalant

Dosage specifications:

When using the recommended antiscalant Pragmaclean 309, dose it depending on the feed water quality:

Soft water	
CaCO ₃ + MgCO ₃ [ppm] ?	250
total hardness [°fH]	25
total hardness [°dH] ?	5,6
PH	6,5-8
Sulfat [ppm]	<14,4

medium-hard water	
CaCO ₃ + MgCO ₃ [ppm] ?	325
total hardness [°fH]	32,5
total hardness [°dH]	5,7 - 11,2
PH	7,5-8,5
Sulfat [ppm]	<17

hard water	
CaCO ₃ + MgCO ₃ [ppm] ?	400
total hardness [°fH]	40
total hardness [°dH]	11,3 - 28
PH	8-9
Sulfat [ppm]	<20

Use only diluted antiscalant!

How to proceed:

Fill the empty canister (20l) with the quantity of antiscalant specified for the existing feed water quality.

Example:

For a WL-ROC-140 with soft feed water, fill 1,3 litres of Pragmaclean 309 into the canister.

For a ROL1200 with hard water, fill 1,7 litres of Pragmaclean into the canister.

Fill the canister up with permeate.

		WL-ROC-140
Canister size [l]		20
Soft water	Dosing antiscalant [l]	1,30
	Dilution factor	15,40
medium-hard water	Dosing antiscalant [l]	1,5
	Dilution factor	13,3
hard water	Dosing antiscalant [l]	1,7
	Dilution factor	11,8

HygroMATIK®

Lise-Meitner-Str.3 • D-24558 Henstedt-Ulzburg
Phone +49(0)4193/ 895-0 • Fax -33
eMail hy@hygromatik.de • www.hygromatik.com
member of **CAREL Group**

