

HygroMATIK®

FlexLine

Control Climate

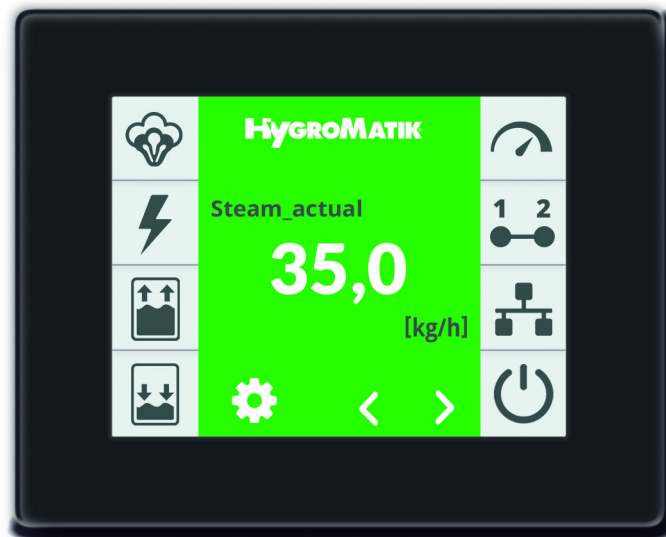

Manual

IMPORTANT: READ AND SAVE THESE INSTRUCTIONS



FL-T.CSA
E-8881766

Certain computer programs contained in this product [or device] were developed by HygroMatik GmbH ("the Work(s)").

Copyright © HygroMatik GmbH [30.08.2021]

FlexLine Control

Validity: This documentation is valid for the control system of the Flexline device series

All Rights reserved.

HygroMatik GmbH grants the legal user of this product [or device] the right to use the Work(s) solely within the scope of the legitimate operation of the product [or device]. No other right is granted under this licence. In particular and without prejudice to the generality of the foregoing, the Work(s) may not be used, sold, licensed, transferred, copied or reproduced in whole or in part or in any manner or form other than as expressly granted here without the prior written consent of HygroMatik GmbH.

Information in this manual is subject to change or alteration without prior notice.

The device-specific wiring diagrams are included in the scope of delivery. Please keep them carefully for future use.

▲ WARNING

Risk of electrical shock!

Hazardous electrical high voltage!

All electrical work to be performed by certified expert staff (electricians or expert personnel with equivalent training) only.

1. Introduction	5
1.1 Typographic Distinctions	5
1.2 Documentation	5
1.3 Symbols in Use	5
1.3.1 Specific Symbols related to Safety Instructions	5
1.3.2 General Symbols	5
2. Safety Instructions	7
2.1 Guidelines for Safe Operation	7
2.1.1 Scope	7
2.1.2 Unit control	7
2.1.3 Unit Operation	7
2.1.4 Mounting, dismantling, maintenance and repair of the unit	8
2.1.5 Electrical	8
2.2 Disposal after dismantling	8
3. Description of control	9
3.1 General description	9
3.2 Layout of control	9
3.3 Mainboard	10
3.3.1 Connections on the mainboard	11
3.4 Expansion board (double cylinder units)	12
3.4.1 Connections on the expansion board	12
3.5 Relay circuit board	13
3.5.1 Connections on the relay board	13
3.6 Electrical connection	14
3.6.1 Connection of control voltage	14
3.6.2 Connection of interlock (safety) system	14
3.6.3 1 step operation	15
3.6.4 Operation with external controller or active humidity sensor	15
3.6.5 Connecting the digital input (DI)	16
3.6.6 Wiring for control signal and release signal for multiple units	16
4. Screen	17
5. Operation of control	19
5.1 Operation basics	19
5.2 Screen 1 - Commissioning	21
5.2.1 Setting the language	21
5.2.2 Input of date and time	21
5.2.3 Control settings	22
5.2.4 Line-up of the commissioning parameters	23
5.3 Screen 2 - Main screen	24
5.3.1 Changing the set point humidity	25
5.4 Password entry	26
5.5 Screen 3 - Main menu (user level)	27
5.6 User level submenus	27

5.6.1 Settings submenu	29
5.6.2 Read values submenu	30
5.6.3 History submenu	32
5.7 Screen 3 - Main menu (operator level)	34
5.8 Operator level submenus	34
5.8.1 Settings submenu	35
5.8.2 Read values submenu	35
5.8.3 Control submenu	36
5.8.4 Service submenu	37
5.8.5 History submenu	39
5.8.6 Blow-down submenu	40
5.8.7 Fill parameters submenu	41
5.8.8 Functions submenu	42
5.8.9 Communication interface submenu	44
5.8.10 Weekly timer submenu	45
5.8.11 Recording submenu	46
5.8.12 Cylinder extension submenu	48
5.8.13 Relay extension 1 submenu	49
5.8.14 Relay extension 2 submenu	50
6. Faults and Warnings	54
6.1 Fault Management	54
6.1.1 Table of Fault Messages, possible Causes and Countermeasures	54
6.2 Service messages and warnings	60
6.3 Table of functional disruptions	61
7. Wiring Diagramms	65
7.1 FLE Single cylinder units	65
7.2 FLE Double cylinder units	71
7.3 FLH Single cylinder units	77
7.4 FLH Double cylinder units	81
7.5 FLP Single cylinder units	83
7.6 FLP Process single cylinder units	87
8. Glossary	91
9. Technical Data	97

1. Introduction

Dear Customer,

Thank you for choosing a HygroMatik steam humidifier.

HygroMatik steam humidifiers represent the latest in humidification technology.

In order to operate your HygroMatik steam humidifier safely, properly and efficiently, please read these operating instructions, which are supplemented by other operating instructions for the relevant basic unit.

Employ your steam humidifier only in sound condition and as directed. Consider potential hazards and safety issues and follow all the recommendations in these instructions.

If you have additional questions, please contact your expert dealer.

For all technical questions or spare parts orders, please be prepared to provide unit type and serial number (see name plate on the unit).

1.1 Typographic Distinctions

- Preceded by a bullet: general specifications
- » Preceded by an arrow: procedures for servicing or maintenance which should or must be performed in the indicated order
- ☑ Installation step which must be checked off.

italics Terms used with graphics or drawings

1.2 Documentation

Retention

Please retain these operating instructions in a secure, always accessible location. If the product is resold, turn the documentation over to the new operator. If the documentation is lost, please contact HygroMatik.

Versions in Other Languages

These operating instructions are available in several languages. If interested, please contact HygroMatik or your HygroMatik dealer.

1.3 Symbols in Use

1.3.1 Specific Symbols related to Safety Instructions

According to ANSI Z535.6 the following signal words are used within this document:

▲ DANGER

DANGER indicates a hazardous situation which, if not avoided, will result in death or serious injury.

▲ WARNING

WARNING indicates a hazardous situation which, if not avoided, could result in death or serious injury.

▲ CAUTION

CAUTION indicates a hazardous situation which, if not avoided, could result in minor or moderate injury.

NOTICE

NOTICE is used to address practices not related to physical injury.

1.3.2 General Symbols

Please note

This symbol is used whenever a situation requires special attention beyond the scope of safety instructions.

Intended Use

The control described is an integral part of a HygroMatik steam humidifier. Use for other applications is not permitted. All instructions on intended use, which are given in connection with the basic device, apply.

Proper usage also comprises the adherence to the conditions specified by HygroMatik for:

- installation
- dismantling
- reassembly
- commissioning
- operation
- maintenance
- disposal

Only qualified and authorised personnel may operate the unit. Persons transporting or working on the unit must have read and understood the corresponding parts of the Operation and Maintenance Instructions and especially the chapter 2. „Safety Notes“. Additionally, operating personnel must be informed of any possible dangers. You should place a copy of the Operation and Maintenance Instructions at the unit's operational location (or near the unit).

By construction, HygroMatik steam humidifiers are not qualified for exterior application.

▲ WARNING

Risk of scalding!

Steam with a temperature of up to 100 °C is produced.

Do not inhale steam directly!

2. Safety Instructions

These safety instructions are required by law. They promote workplace safety and accident prevention.

2.1 Guidelines for Safe Operation

2.1.1 Scope

Comply with the accident prevention regulation „DGUV Regulation 3“ to prevent injury to yourself and others. Beyond that, national regulations apply without restrictions. This way you can protect yourself and others from harm.

2.1.2 Unit control

Do not perform any work which compromises the safety of the unit. Obey all safety instructions and warnings present on the unit.

In case of a malfunction or electrical power disruption, switch off the unit immediately and prevent a restart. Repair malfunctions promptly.

⚠ WARNING

Restricted use.

IEC 60335-1 stipulates as follows:

This device may be used by children of eight years of age and above as well as by persons with reduced physical, sensory or mental capabilities or lack of experience and knowledge so long as they are supervised or have been instructed regarding the safe use of the device and understand the hazards that may result from it. Cleaning and user maintenance of the unit must not be undertaken by children without supervision.

2.1.3 Unit Operation

⚠ WARNING

Risk of scalding!

Uncontrolled hot steam escape in case of leaking or defective components possible. Switch off unit immediately.

⚠ WARNING

For Ministeam devices applies:

Risk of scalding!

No persons may be under the cloud of steam blowing out (at a distance of approx. 1 m/40 inch in the direction of blowing out and 0.5 m/20 inch on both sides of the device).

NOTICE

Risk of material damage!

- The unit may be damaged if switched on repeatedly following a malfunction without prior repair. Rectify defects immediately!
- The unit must not be operated on a DC power supply.
- The unit may only be used connected to a steam pipe that safely transports the steam (not valid for MiniSteam units).
- Regularly check that all safety and monitoring devices are functioning normally. Do not remove or disable safety devices.
- Steam operation is only allowed when the unit cover is closed.

NOTICE

Water leaks caused by defective connections or malfunctions are possible.

Water is constantly and automatically filled and drained in the humidifier. Connections and water-carrying components must be checked regularly for correct operation.

2.1.4 Mounting, dismantling, maintenance and repair of the unit

NOTICE

The HygroMatik steam humidifier is IP20 protected. Make sure that the unit is not object to dripping water in the mounting location.

Installing a humidifier in a room without water discharge requires safety devices to protect against water leakages.

- Use genuine spare parts only
- After any repair work, have qualified personnel check the safe operation of the unit
- Attaching or installing of **additional components** is permitted only with the **written consent** of the manufacturer

NOTICE

Do not install HygroMatik steam generators above electrical equipment such as fuse boxes, electrical appliances, etc. In the case of a leakage, leaking water can damage the underlying electrical equipment

2.1.5 Electrical

⚠ WARNING

Risk of electrical shock!

Hazardous electrical voltage!

Any work on the electrical system to be performed by certified expert staff (electricians or expert personnel with comparable training) only.

Steam operation may only be started when the unit cover is closed.

During maintenance or installation work, the device must be disconnected from the power supply and secured against being switched on again. The absence of voltage must be ensured by a measurement.

Leaks can cause leakage currents. Observe safety regulations on working with voltage parts (applies to electrode steam humidifiers).

After electrical installation or repair work, test all safety mechanisms (such as grounding resistance).

NOTICE

Use only original fuses with the appropriate amperage rating.

Regularly check the unit's electrical equipment. Promptly repair any damage such as loose connections or burned wiring.

Responsibility for intrinsically safe installation of the HygroMatik steam humidifiers is incumbent on the installing specialist company.

2.2 Disposal after dismantling

The humidifier is made up of metal parts and plastic parts. In reference to European Union directive 2012/19/EU issued on 4 July 2012 and the related national legislation, please note that:

The components of the electrical and electronic devices must not be disposed of as municipal waste, and therefore the method of waste separation must be applied. The public or private waste collection systems defined by local legislation must be used.

NOTICE

The operator is responsible for the disposal of unit components as required by law.

3. Description of control

3.1 General description

The control is integrated into the steam humidifier and is operated via a 3.5" graphic display on the front of the unit.

The only other operating element, which is also located on the front of the unit, is a control switch whose positions are assigned as follows:

Pos. "0": The unit is switched off

Pos. "I": The unit is switched on and the control is active

Pos. "II": The cylinder water is pumped off manually without the participation of the control. The control is not active, the display remains dark.

Control switch



By changing the parameters, the user/operator can adapt the control to the system specifications and the special characteristics relating to the use of the unit.

Details of the operation of the unit are provided in the Glossary (see Section 6).

3.2 Layout of control

The control consists of the 3.5" screen and the mainboard. The mainboard can be expanded for additional functions with one or 2 relay boards (with 3 relays each) and additional optional relays in DIN rail format.

The relay boards are connected to the mainboard via a plug system.

The DIN rail relays are connected via cables with plug. 2 additional relay modules can be used, with 2 relays each.

For use with double cylinder units, an expansion board is added to the mainboard.

The fuse protection of the control voltage for all boards with 2 x 2.5 A fast (F1, F2) takes place on the mainboard.

The external circuitry for the control voltage and the interlock (safety) system are connected directly to the mainboard on plug ST1. If additional boards are connected, the connection moves from the mainboard to the outermost board (see sketch).

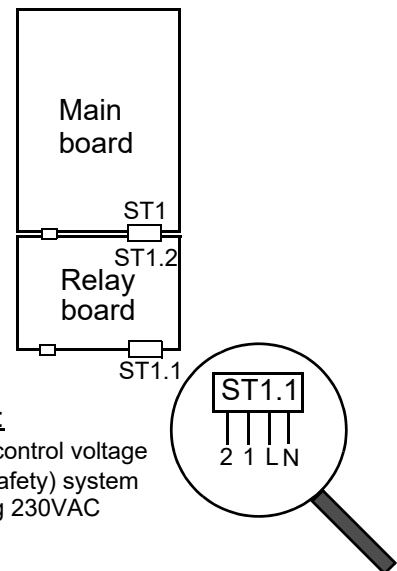

Connections:

- L, N: 230 VAC control voltage
- 1,2: Interlock (safety) system non-floating 230VAC

Please note

For device versions with separate control voltage, this is connected to clamps L and N. For versions with internal control voltage and control voltage transformer, the wiring is pre-installed here.

3.3 Mainboard

The mainboard is "the heart" of the control. All logic functions and control operations for the steam humidifier are provided here. The relays for the control of the main contactor, solenoid valve and blow-down pump are included directly on the mainboard.

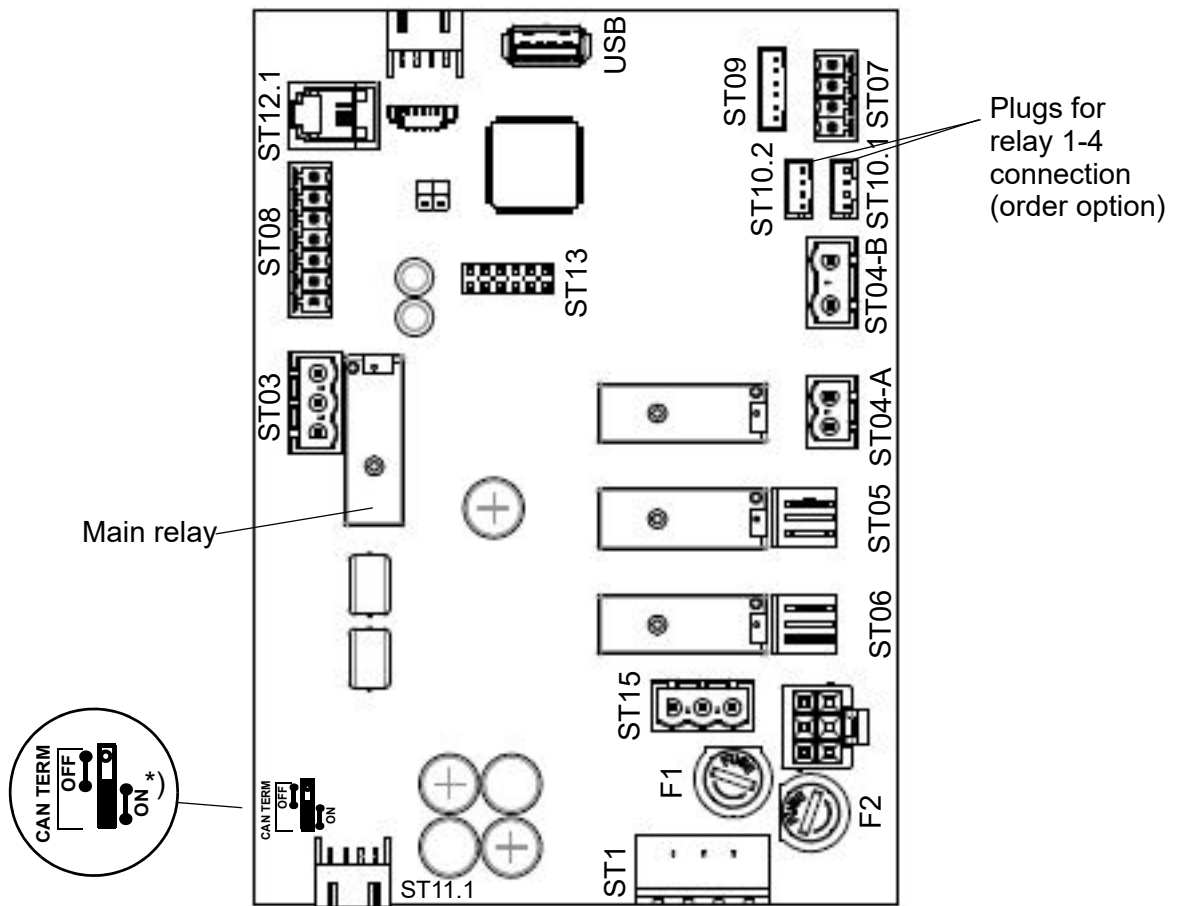

*) This jumper must always be set to „ON“

Ex-factory relay assignment:

In case of a unit without any additional options built in, assignment of the base relay (ST03) is „Collective fault“ (0). All other relay contacts carry the assignment „Not in use“ (284).

3.3.1 Connections on the mainboard

The use of the connections is illustrated by the wiring diagrams (see chapter 7)

3.3.1.1 Customer-side computer interfaces

Inputs

ST08:

- Control signal input 0...10 VDC
- Control signal input 0...20 mA
- Control signal input 0...140 ohm
- Configurable digital input 12 VDC

Outputs

ST03:

- Potential free break/make contacts NC and NO, programmable, relay assigned to "Collective fault" in factory setting

ST10.1/ST10.2:

- Connection options for an optional relay each in DIN rail version with wiring harness (order option)

ST07:

Control output 0...10 VDC (max. 8 mA)

ST08:

- +20 VDC supply voltage (max. 20 mA) for humidity sensors

ST15:

- Tap for 1,2 and N (unsecured) for customer use

USB:

Connection for USB stick for use as a data logger and for parameter updates

3.3.1.2 System-side interfaces

ST1:

- 4-pin screw / plug connection for the connection of L1 and N and the interlock (safety) system

ST11.1:

- +12 V, GND, CAN bus

Inputs

ST09:

- Input for current transformer (ELDB) / level control (HKDB) with automatic detection (for explanation of terms see Glossary, Index 7)

ST04-B:

- Galvanically isolated input (optical coupler) for sensor electrode

Outputs

ST04-A:

- Main contactor

ST05:

- Blow-down pump

ST06:

- Inlet solenoid valve

Bi-directional

ST12.1:

- Serial interface for screen connection

ST 13:

- Base for adapter board with RS485 interface

3.4 Expansion board (double cylinder units)

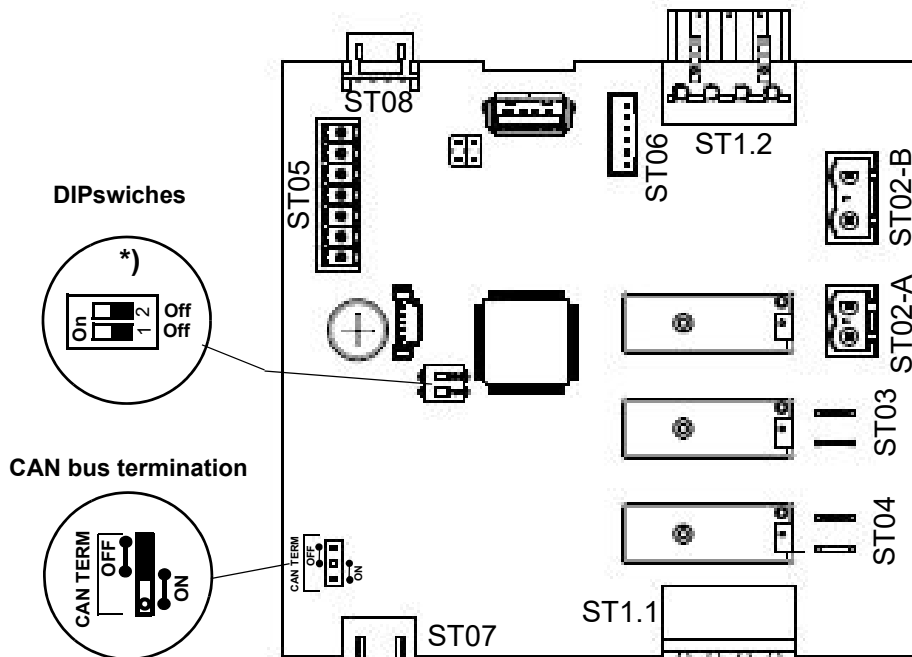

*)The DIP switches serve for CAN bus address setting. They are factory preset according to the unit configuration.

**) The jumper for the CAN bus termination is in the „ON“ position only on the lowest extension or relay board of the assembly, i.e. the termination is then effective. On the boards that are attached in higher mounting positions, the correct

3.4.1 Connections on the expansion board

3.4.1.1 Customer-side computer interfaces

Inputs/outputs

ST05: not used

3.4.1.2 System-side interfaces

ST1.1:

- 4-pin screw / plug connection for the connection of L1 and N and the inter-lock (safety) system

ST1.2:

- Loop-through of ST1.1

ST07:

- +12 V, GND, CAN-Bus

ST08:

- Loop-through of ST07

Inputs

ST02-B

- Electrically isolated input (optical coupler) for sensor electrode (ELDB)
- Thermoswitch connection (HKDB)

ST06:

- Input for current transformer (ELDB) / level control (HKDB) with automatic detection

Outputs

ST02-A:

- Main contactor

ST03:

- Blow-down pump

ST04:

- Inlet solenoid valve

3.5 Relay circuit board

The relay board has three additional relays with potential free break/make contacts (contact load 250 VAC/8 A) for switching or controlling of additional functional units or options.

A maximum of 2 relay boards can be installed. When 2 boards are in use, different CAN bus addresses must be set (see fig. below).

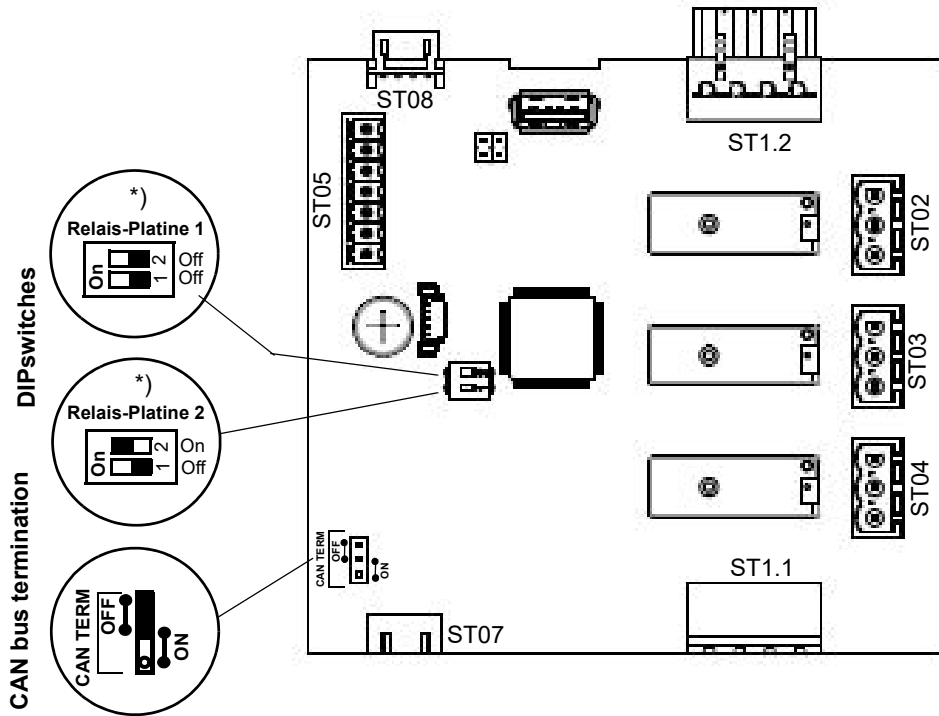

*) The DIP switches serve for CAN bus address setting. They are factory preset according to the unit configuration.

**) The jumper for the CAN bus termination is in the „ON“ position only on the lowest extension or relay board of the assembly, i.e. the termination is then effective. On the boards that are attached in higher mounting positions, the correct jumper setting is „OFF“. On the main board the correct setting of the Can-Bus termination is always "ON".

3.5.1 Connections on the relay board

3.5.1.1 Customer-side interfaces

Inputs

ST05:

- Configurable digital input 12 VDC

Outputs

ST02:

- Potential free break/make contacts NC and NO, programmable

ST03:

- Potential free break/make contacts NC and NO, programmable

ST04:

- Potential free break/make contacts NC and NO, programmable

3.5.1.2 System-side interfaces

ST1.1:

- 4-pin screw / plug connection for the connection of L1 and N and the interlock (safety) system

ST1.2:

- Loop-through of ST1.1

ST08:

- +12 V, GND, CAN bus

ST07:

- Loop-through of ST08

3.6 Electrical connection

⚠ WARNING

Danger of electric shock!

Dangerous electric voltage!
All work relating to the electrical installation may only be carried out by designated specialist personnel (electrician or qualified person with equivalent training).

Please note

The customer is responsible for monitoring the qualifications of the specialist personnel.

NOTICE

Potential component damage due to electrostatic discharge!

To protect the sensitive electronic components, measures to prevent damage due to electrostatic discharge must be taken before the start of the installation work.

3.6.1 Connection of control voltage

The control voltage of 230 VAC is to be applied to the board which is closest to the cable gland on the underside of the housing. The plug designation differs depending on the level of expansion:

Type of board	Plug designation
Mainboard	ST1
Expansion board	ST1.1
Relay circuit board	ST1.1

The pin assignment is identical for all plugs. L and N are labelled on the terminals. The pins are accessible via a terminal strip adaptor pushed on the corresponding plug.

For device versions with internal control voltage, no voltage must be applied to L and N. The wiring is pre-installed here.

3.6.2 Connection of interlock (safety) system

The so-called interlock (safety) system is located between terminals 1 and 2 with terminal 1 holding 230 VAC. For closing the interlock, a make contact is required across terminals 1 and 2. This contact is supplied by relay K21. For energising the relay, a make contact or a bridge is required across the additional terminals on the hat-top rail.

If the interlock (safety) system is open, the humidifier does not start or the operation is interrupted.

In air conditioning, it is standard to incorporate a max. hygrosat in the interlock (safety) system. The max. hygrosat is used as a safety feature in case of a malfunction of the humidity sensor.

⚠ WARNING

Danger of electric shock!

Dangerous electric voltage!
After the commissioning of the unit, a 230VAC voltage is present at terminal 1 when standard wiring is used.

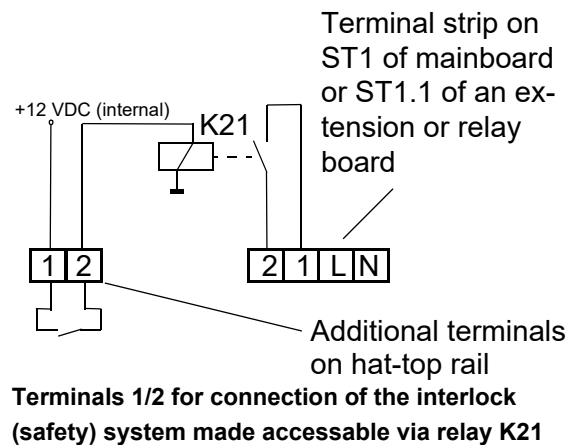

Safety equipment can be wired (also in series) into the interlock (safety) system, as shown in the fig. below:

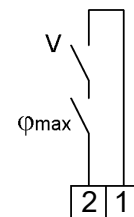

Please note

The interlock (safety) system is not closed when delivered ex-factory.

3.6.3 1 step operation

The operation of the steam humidifier is controlled via terminals 3 and 5 by the contact which is to be provided on-site. The contact only has to be suitable for low voltage.

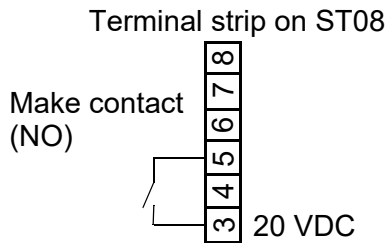

Terminals 3/5 on the mainboard (terminal strip on ST08) provided for 1-step operation

3.6.4 Operation with external controller or active humidity sensor

When the steam humidifier is controlled via an external controller (e.g. a PLC) or an active humidity sensor, physical control signals can be processed in the range 0...10 V, 0...20 mA or 0...140 Ω. A separate terminal is provided on the board for each of these signal types (also see chapter 7, „Wiring diagrams). Terminal 4, "GND" is the reference potential in each case.

Wiring examples:

External controller

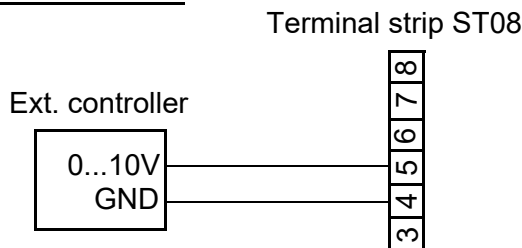

Terminals 4/5 on the mainboard (terminal strip ST08) provided for connection of an ext. control signal 0...10V

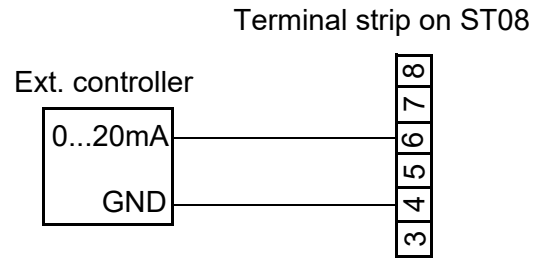

Terminals 4/6 on the mainboard (terminal strip on ST08) provided for connection of an ext. control signal 0...20mA

Humidity sensor

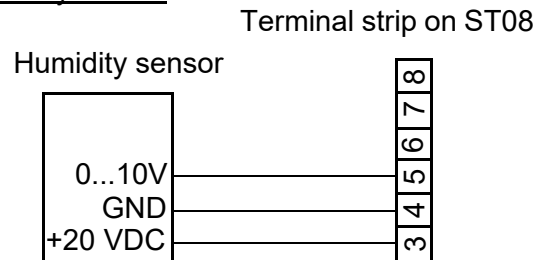

Terminals 3/4/5 on the mainboard (terminal strip on ST08) provided for connection of a humidity sensor 0...10V

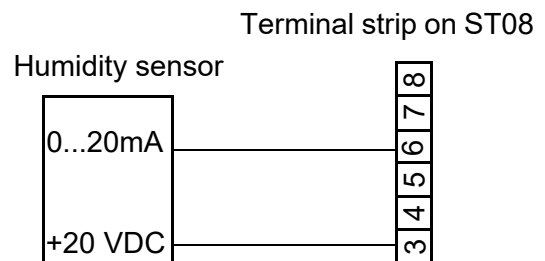

Terminals 3/6 on the mainboard (terminal strip on ST08) provided for connection of a humidity sensor 0...20mA

Please note

Humidity sensors require an external supply voltage. 20 VDC are available for this purpose at terminal 3.

3.6.5 Connecting the digital input (DI)

The digital input on the mainboard can be used for switching functions.

The digital input must be wired on-site in accordance with its use, e.g. with as push-button or a switch (also see chapter 5.8.8 „Function parameters“).

Digital input (DI) wiring examples

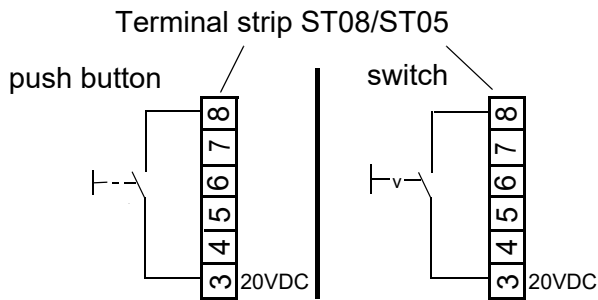

Terminals 3/8 provided for connecting the digital input

- mainboard (terminal strip ST08)
- extension board/relay board (terminal strip ST05)

3.6.6 Wiring for control signal and release signal for multiple units

In the case of multiple units, separate humidifiers work together. The control signal and the release signal are connected to the master unit as described above. In addition, connecting cables are established between the master unit and the slave unit(s) (provided on-site). These provide the slave unit with a control signal from the master and the transmitted (potential free) release signal.

The wiring for the control signal and release signal must be implemented as follows for multiple units:

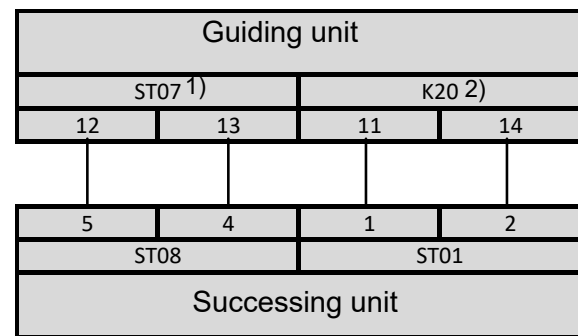





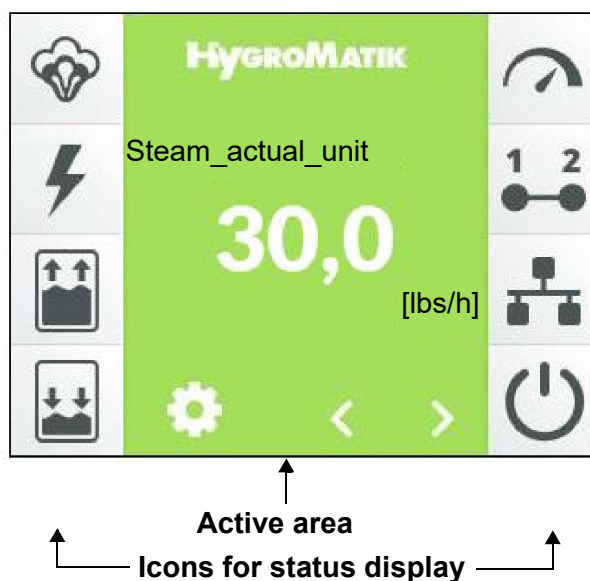

1) „ST07“ designates the connector plug on the mainboard

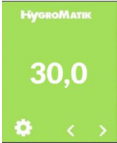
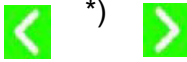





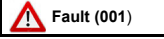

2) „K20“ is the relay used for the connection of the successing unit with the installed option (CN-07-10012) or the enclosed option (CN-07-10002)

4. Screen



Active screen area	Use
	Main display for operating values, navigation using the scroll keys ^{*)} .
 ^{*)}	Scroll buttons can be used to display the following operating values: <ul style="list-style-type: none"> • Humidity_actual_value [%] • Humidity_set-value [%] ^{1),2)} ; touching it opens a screen keyboard ^{**)} that allows for changing the set value • Steam_actual_unit [lbs/h] • Steam_output_max. [%] • Demand [%] • Control_signal_internal [%] • Output_signal • Current_actual_cyl. 1 [A] (Electrode steam humidifiers only) • Current_actual_cyl. 2 [A] (Electrode steam humidifier double cyl. units only) • Waterlevel_cyl. 1 [inch] (Heater steam humidifiers only) • Waterlevel_cyl. 2 [inch] (Heater steam humidifier double cylinder units only) <p>¹⁾only when „PI controller“ is set ²⁾ not in „Weekly timer“ mode; exemption: when „ECO“ is selected as the steam production mode, the humidity set-value is output in „Weekly timer“ mode as well.</p>
^{**)} 	Screen keyboard for changing the humidity set value; is displayed when the humidity set value display is touched; allows direct changing of the set value. Saving of the input by touching the confirmation tick in the upper right corner, exit without saving by touching the „X“ in the upper left corner.

Active screen area	Use
	Button to call up set-up mode (via password). Password „000“ -> operating functions of user level (see Section 5.5) Password „010“ -> operating functions of operator level (see Section 5.7)
  	In the event of a fault or a service message, the relevant display field is shown instead of the HygroMatik logo. Touching it opens the unit info screen (see Section 5.9).
	Unit info screen (see Section 5.9) for the display of error and service messages in plain text. Is displayed by touching the error or service message.

Icon	Status	Meaning
	dark bright flashes	Steam generation active No steam generation Fault steam generation
	dark bright flashes	Main contactor switched Main contactor not switched Fault main contactor
	dark bright flashes	Filling active No filling Fault filling
	dark bright flashes	Blow-down active No blow-down Fault blow-down <u>Manual blow-down</u> A manual blow-down can be triggered by touching the icon. Touching the icon again stops the manual blow-down. Max. blow-down time corresponds to the parameter setting for full blow-down
	dark bright flashes	Demand has been made Demand has been made Fault demand
	dark bright	Interlock (safety) system closed Interlock (safety) system open
	dark bright	Virtual interlock (safety) system closed (via communication interface) Virtual interlock (safety) system open
	dark bright flashes	Operating mode display No humidity control enabling due to e.g. open safety interlock (details can be found in Read_values/Status_unit). Unit is in the initialisation phase

5. Operation of control

5.1 Operation basics

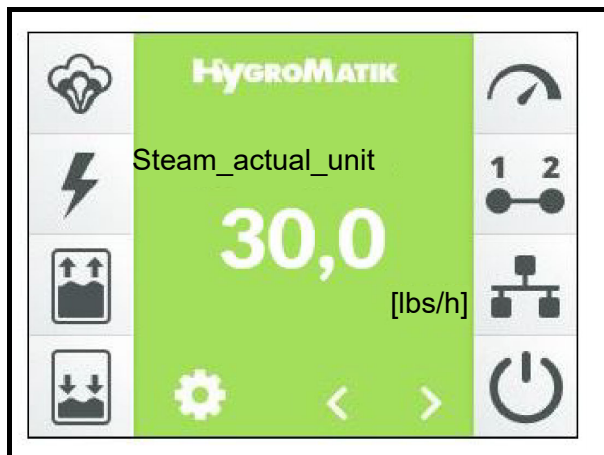

Operation takes place via the built-in touch-sensitive 3.5 inch screen. It is used for all operating steps required for the settings and operation of the unit. In addition to operating the unit directly, it is possible to control it remotely via the building technology control system or a PLC, using the communication interface. Supplementary documentation is available from HygroMatik for this type of application.

Screen views

The operating structure uses several screens, which are schematically displayed in the table below.

User guidance

In the user guidance, a distinction is made between the "user level" and "operator level". While the user level only makes it possible to carry out basic device operations, the operator level also permits operating parameters to be changed. The 2nd table below clarifies this again. The possible operating functions of the two levels are presented in Sections 5.5 and 5.7.

Overview of the screens

	Content of screen page	Presentation	Sec.
Screen 1 Initial operation	Used for the basic unit settings (e.g. user language) after the unit is switched on for the first time. This page is then closed. To do so, use the confirmation tick to exit it.		5.3
Screen 2 Main screen	Displays the current operating values and unit status information (status icons).		5.4
View 3 Main menu (user level)	Allows access to submenus for limited unit settings, read values and history		5.5
View 3 Main menu (operator level)	Allows access to submenus for comprehensive unit settings, read values, parameter settings, service settings and history		5.7
Screen 4 Unit information	Is only displayed after a fault or a service message has occurred; provides information on device data, statistics, faults that have occurred and service requirements.		5.9

Operating ranges at the user/operator level

Level	Permits
User level	<ul style="list-style-type: none"> • Display of the read values of the main screen • Setting the humidity set value in the main screen • Display of the unit information after a fault or status message • After entering the password - call-up and cancellation: Display of the complete list of read values and adjustment options for some service parameters
Operator level	<ul style="list-style-type: none"> • All functions of the user level • Advanced settings options for operation and service parameters

5.2 Screen 1 - Commissioning

After connection to the mains supply and initial actuation of the control switch, the commissioning screen for the basic device settings appears on the display once the self-test of the control has been completed:

X	01: Commissioning	✓
01: Language	English	
02: Date	31/10/2017	
03: Time	11:59	
04: Control	User-defined	

5.2.1 Setting the language

- » Touch the line with parameter "01: Language". The following screen is displayed:

<	Language	✓
German		
English		✓
Français		
Castellano		∨

- x The currently selected language is marked with a tick in the relevant line. With the scroll-down button, the 2nd page of the screen is displayed if required
- » Change the language by touching it, if required

- » Confirm the input and return to the "Initial operation" screen with the green tick in the top right (cancel by touching "X")

5.2.2 Input of date and time

The parameter "02: Date" and "03: Time" require digits to be entered. To do so, a screen with a keyboard and an input field in the date or time format will be displayed after touching the relevant line.

As an example, the date input is described below:

- » Touch line "02: Date". The following screen is displayed:

X	Date	✓
28.10.17	1 2 3	
	4 5 6	
	7 8 9	
	. 0	⌫

- » Enter the date in the format DD.MM.YY (D = day, M = month, Y= year) as digits only (the dots are added automatically)
- » Confirm the input and return to the "Initial operation" screen with the green tick in the top right (cancel by touching "X")

5.2.3 Control settings

The type of unit control is specified in the next step. The screen offers the most commonly used combinations of the operating mode of the control (1 step, controlled with an external regulator, with the internal PI controller, via the communication interface, slave operation), the type of control signal (voltage, current or resistance signal) and the control signal range (e.g. 0... 10 V). If these values have already been factory-preset according to customer requirements, the selection tick appears in the "User-defined" line.

The parameters are displayed in blocks on a screen page, which include a maximum of 4 entries. Scroll keys are used to switch between the individual screen blocks.

The initial operation is now complete. If the initial operation screen was exited with the confirmation tick, the main screen is automatically shown in the display. The initial operation screen is no longer displayed in future. Future changes with respect to the parameters set during initial operation must be made on operator level in submenus „Settings“ and „Control“.

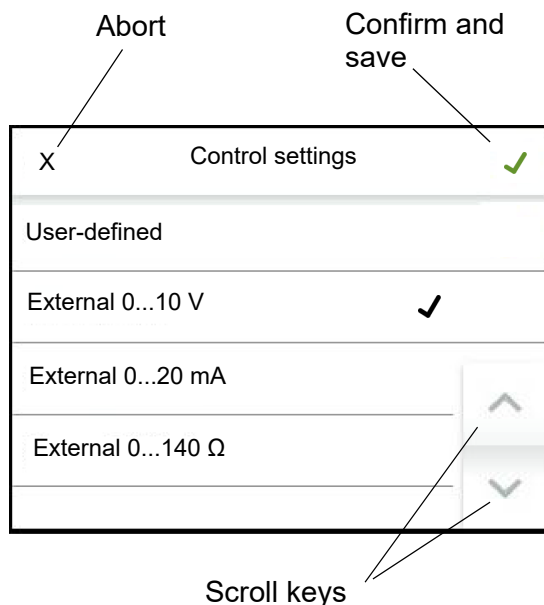

- » Confirm the input and return to the "Initial operation" screen with the green tick in the top right (cancel by touching "X")
- » Pressing the green tick in the top right saves the entries and exits the initial operation screen (cancel by pressing the "X")

5.2.4 Line-up of the commissioning parameters

Table of commissioning parameters

01: Commissioning

No. Parameter	No.	Adjustment/value range Factory setting (FS) Bold min max FS	Meaning/Comment [] explains the term in the glossary -> [] refers to a related explanation of the term
1 Language		Selection	Selection of language
	0	Deutsch	German
	1	English	English
	2	Francais	French
	3	Castellano	Spanish
	4	日本語	Japanese
	5	Italiano	Italian
	6	Русский	Russian
	7	Svensk	Swedish
2 Date		DD.MM.YY	Set date
3 Time_of_day		HH:MM	Set time
4 Control_settings		Selection	Combinations of control type and input signal type/range
	0	User_specified	The selection was carried out separately during initial operation according to control type, signal type and area. This is a read value only
	1	Extern_0...10 V	External controller [73] with voltage signal 0... 10 V
	2	Extern_0...20 mA	External control [73] with current signal 0...20 mA
	3	Extern_0...140 Ω	External controller [73] with ohmic signal 0...140 Ω
	4	PI-controller_0...10 V	Internal PI controller [96], controls with voltage signal 0...10 V
	5	PI-controller_4...20 mA	Internal PI controller [96], controls with current signal 4... 20 mA
	6	PI-controller_0...140 Ω	Internal PI controller [96], controls with ohmic signal 0...140 Ω
	7	1-step	1 step operation [44]
	8	Modbus	Control via software control commands [12] through communication interface [13]
	9	Slave	Unit operates as slave [94] in a master/slave unit network
	11	Pi-controller_V_max_mA	Selection of current input on the mainboard for the 2nd PI controller when using the floating max. limiter [35]
	12	Pi-controller_V_max_V	Selection of voltage input on the 1st relay board for the 2nd PI controller when using the floating ma. limiter [35]

5.3 Screen 2 - Main screen

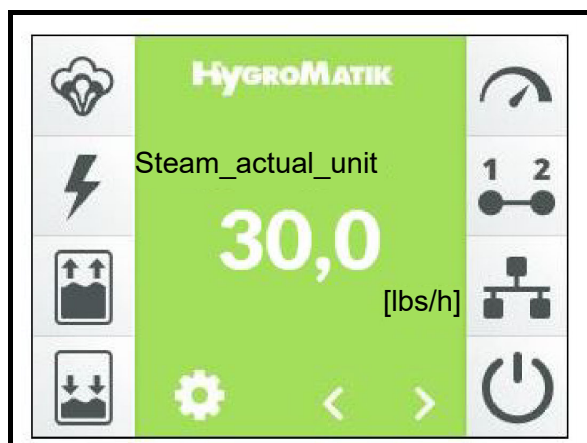



and the dimmed state can be adjusted by the user, as well as the duration after which the main screen is changed to the dimmed state.

The main menu of the user level and the operator level (screen 3) is accessed by touching the  icon. List of read values and target humidity of the main screen

The main screen is shown in the display after the unit is switched on, unless the unit is being switched on for initial operation (see Section "Initial operation"). In the main screen, current operating values are represented as numerical information, as well as status information in the form of icons. The display elements were described in Section 4 "The screen". A flashing icon always indicates a fault.

The left row of icons refers to the operational conditions of the unit. The right row of icons indicates the status of releases. For steam production to take place, all icons on the right side of the screen must be active.

The scroll keys  and  allow the user to move through the list of display values on the main screen (see Section 4, "The screen"). With the exception of the target humidity, these are read values only. The displayed values are shown and explained in the table in the following section.

If an error has occurred or a service message is issued, a display field with the relevant message is displayed instead of the Hygro-Matik logo. The user can access the unit info screen by touching this field.

The brightness of the main screen is reduced after a certain time (screen brightness is dimmed). The two scroll keys and the settings icon are also hidden at this point. The original state is restored by touching the screen.

The values for the normal display brightness

Table of the read values available in the main screen and the humidity set value

Main display

No.	Parameter	No.	Adjustment/value range			Meaning/Comment [] explains the term in the glossary -> [] refers to a related explanation of the term	
			Factory setting (FS)	min	max		FS
1	Humidity_actual_value					Read value	Actual value [1] of rel. humidity [2] in %
2	Humidity_set_value		0.0	99.0	50.0		Set value [3] of RH [2] in %
8	Steam_actual_unit					Read value	Current steam output of the unit [4] in lbs/h
9	Steam_output_max.					Read value	Set value of maximum output power [43]
10	Demand					Read value	The demand [5] is the control signal from which the internal actuator signal [42] is created
11	Control_sig_internal					Read value	Internal actuator signal [42] as a percentage of the actuator signal for the nominal output
12	Output_signal					Read value	Output signal [69] on terminals 12, 13 proportional to input signal
13	Current_actual_cyl. 1					Read value	The current power consumption of cylinder 1 (only for ELDB [77])
14	Current_actual_cyl. 2					Read value	The current power consumption of cylinder 2 (only for ELDB [77] double cylinder units)
17	Water_level_cyl. 1					Read value	Water level in cylinder 1 in inch (only for HKDB [78])
18	Water_level_cyl. 2					Read value	Water level in cylinder 2 in inch (only for HKDB [78] double cylinder units)
20	Humidity_actual_max					Read value	Actual value [1] of rel. humidity [2] in % whwn floating max. limiter [35] is activated
21	Humidity_set_max		5.0	99.0	80.0		Specification of max. humidity for the switch-off point when using the floating max. limiter [35]

5.3.1 Changing the set point humidity

- » Select the "Humidity_set value [%]" screen using or .
- » Tap on the Humidity_set value display.
- » Enter the value of the intended humidity set value using the on-screen keyboard which has opened.
- » Confirm the input and save using the check mark in the top right, cancel using the "X" in the top left.

5.4 Password entry

The password determines if the main menu of the user level or the operator level is displayed. The password codes in use are:

Code 000: The main menu of the user level becomes accessible. However, it is sufficient to leave the password prompt with the green tick, without explicitly entering the code.

Code 010: The main menu of the operator level becomes accessible.

The password entry is called up in the main screen by touching the  button. A virtual keyboard is shown on the screen for entering the password:

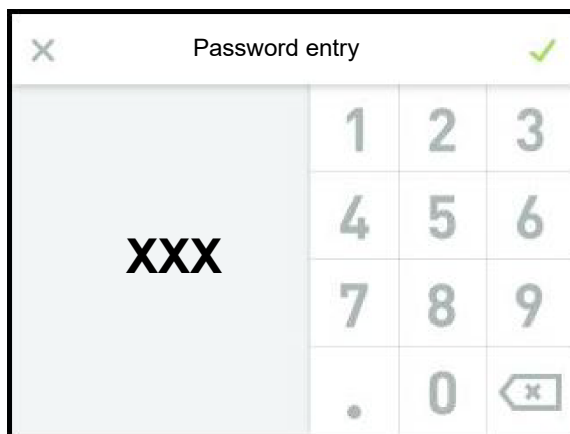



To open the user level, it is sufficient to select the X symbol (top left). The operator level is accessed through the sequential input of the code digits "0", "1" and "0" and confirming them with the green tick (top right).

5.5 Screen 3 - Main menu (user level)

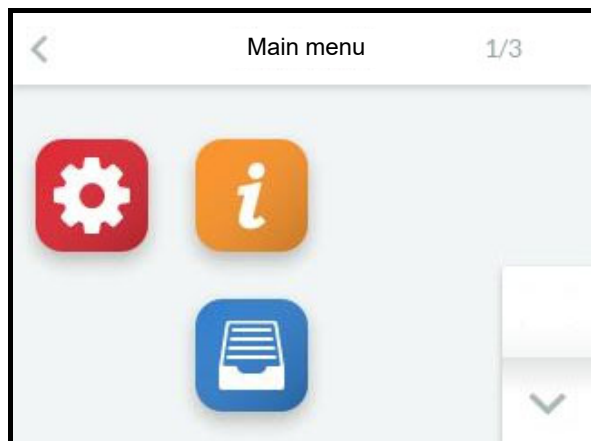
After selecting the user level, the icons of the submenus which are available to the user are displayed:



5.6 User level submenus

Icon	Selection of submenu
	Settings
	Read values
	History

By tapping on the respective icon, the user accesses the screen page where the parameters of the respective group are displayed for selection, viewing or for making changes.

Layout of screen page

The input fields in which changes can be made are shown in *italics*. Depending on the parameter, the input has to be made by:

- selection from predefined offers (multiple choice, see example 1)
- entry of numeric values using an on-screen keyboard (see example 2).

Example 1: Selection of user language:

Call up the language selection on the screen by touching "Language:



By tapping on the required language, the black tick moves to the corresponding row. By touching the green tick (top right), the selection is saved and the display returns to the parent screen.

If the settings are to remain unchanged, it is possible to return straight away using the < key.

Example 2: Setting the screen brightness

Touch "Screen_brightness normal" on the screen to call up the input mask:

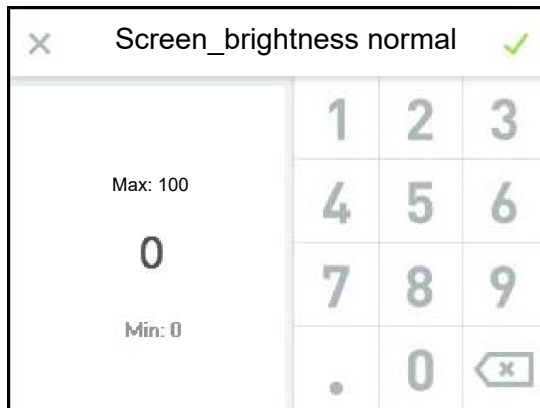

The screen brightness which is set is displayed and can be changed by using the keyboard. Save and return by touching the green tick, leave the input mask without changes by touching the "X".

The screens are hidden after a certain period of time. The main screen is then displayed. The time until the return to the main screen can be set by the user.

If a submenu is to be called up again after a screen has been closed automatically by a time-out, this can only be done through the settings icon in the main screen. This also means that the password has to be re-entered. As long as the user continues their work in the area of the main screen, the existing access remains, i.e. no renewed password entry is required.

5.6.1 Settings submenu



Table of settings parameters

03: Settings

No.	Parameter	No.	Adjustment/value range			Meaning/Comment [] explains the term in the glossary → [] refers to a related explanation of the term
			min	max	FS	
1	Language		Selection see: 01-1 Language			Selection of language
2	Date		DD.MM.YY			Set date
3	Time_of_day		HH:MM			Set time
4	Display_lighting_normal		5	100	100	Screen backlight in undimmed state
5	Delay_present_page		0	3600	300	Display duration for a certain screen page before return to the main screen in min
6	Display_lighting_dimmed		0	100	50	Screen brightness for dimmed state
7	Display_dim_after		0	3600	120	Switching of screen brightness of main screen to dimmed value after ... seconds. If an error has occurred or a status message is displayed, the main screen is not dimmed

5.6.2 Read values submenu



Read values table (visible on the user and the operator level)

04: Read values

No. Parameter	No.	Adjustment/value range Factory setting (FS) Bold min max FS	Meaning/Comment [] explains the term in the glossary →[] refers to a related explanation of the term
1 Status_unit		Read value	Operating condition of unit
	0	Initialization	Control performs initialisation [10]
	1	Safety_interlock_open	Unit is ready for steam production, but the interlock (safety) system [11] is open
	2	No_Demand	Unit is ready for steam production, but there is no demand [5]
	3	Humidification	Humidifying [47]
	4	Runtime_limitation	Unit has switched off after limitation of operating time was reached [32]
	5	Remote_off	Unit was switched off via a software command [12] for opening the interlock (safety) system [83] via the communication interface [13]
	6	No_bus-signal	Steam production was switched off manually via the on/off button [14]
	7	Standby_heating_heating	The standby heating [16] is in the heating phase
	8	Standby_heating_interval	The standby heating [16] is in the resting phase
	9	No_demand_ECO	There is no demand [5] in ECO mode [61]
	10	Humidification_ECO	Humidifying in ECO mode [61]
	11	Timer_steam_off	Steam is not produced after the timer [18] has expired
	13	Weekly_timer_steam_off	No steam is produced after the weekly timer has run out
	14	Digital_input_steam_off	Steam production was cut via the digital input [97]
	270	Service_message	A service message has appeared. For detailed specification, see read value 8 for cyl. 1 and read value 9 for cyl. 2 (double cylinder units only)
	900	Diagnosis	Unit is performing diagnostics [15]
	901	Not_programmed	The control electronics is not yet programmed for the unit type
	902	Update_in_progress	A USB stick was plugged in and a parameter upgrade is run by the unit
	903	Restart	A parameter upgrade was successfully carried out. Restart of the unit is required
	999	Fault	There is a fault
2 Status_cyl. 1		Read value	Status of cylinder 1
	0	Initialization	Unit is in initialization phase →[10]
	1	Safety_interlock_open	Cyl. 1 is ready for steam production, but the interlock (safety) system [11] is open
	2	No_Demand	Cyl. 1 is ready for steam production, but there is no demand [5]
	3	Humidification	Humidifying [47]
	30	Filling_valve 1	Filling via solenoid valve 1 [19]
	32	Filling_valve 1 a. 2	Filling via solenoid valve 1 and solenoid valve 2 [19]
	60	Start_blow-down	At the start of operation, the unit performs a start blow-down [20]
	61	Part_blow-down	A partial blow-down [21] is performed
	62	Full_blow-down	A full blow-down [22] is performed
	63	Dilution	The unit performs a dilution [23] of the cylinder water (only ELDB [77])
	64	Max_current_blow-down	The unit performs an overcurrent blow-down [24] because the measured current is too high (only for ELDB [77])
	65	Max_level_blow-down	The unit performs a max. level blow-down [25] because the water level is too high (only for HKDB [78])
	66	Standby_blow-down	The unit performs a Standby blow-down [26], because the maximum duration without demand [5] has been reached
	67	Dead_leg_flushing	A dead-end line flushing is performed [27]
	68	Manual_blow-down	A manual blow-down [28] was triggered
	81	Part_blow-down_pending	A partial blow-down [21] is performed before the next filling process
	82	Full_blow-down_pending	A full blow-down [22] is performed before the next filling process
	90	Cylinder_full	The sensor electrode reports when the maximum water level in the cylinder has been reached (only for ELDB [77])
	270	Service_message	A service message has appeared. For detailed specification, see read value 8 for cyl. 1 and read value 9 for cyl. 2 (double cylinder units only)
	900	Diagnosis	The unit is in diagnostic mode [15]
	999	Fault	There is a fault
3 Status_cyl. 2		Read value	Status of cylinder 2 (as cylinder 1)
		see: 04-2 Status_cyl. 1	
4 Fault_message_unit		Read value	List of possible unit fault messages
		see: 02-1 Fault_message_unit	
5 Fault_message_cyl. 1		Read value	List of possible fault messages for cylinder 1 (see Fault_message_unit)
		see: 02-2 Fault_message_cyl. 1	
6 Fault_message_cyl. 2		Read value	List of possible fault messages for cylinder 2 (see Fault_message_unit)
		see: 02-2 Fault_message_cyl. 1	
8 Service_message_cyl. 1		Read value	List of service messages for cylinder 1
		see: 02-5 Service_message_cyl. 1	
9 Service_message_cyl. 2		Read value	List of service messages for cylinder 2
		see: 02-5 Service_message_cyl. 1	

Read value table (ctd.)

04: Read_values

No.	Parameter	No.	Adjustment/value range			Meaning/Comment [] explains the term in the glossary ->[] refers to a related explanation of the term
			Factory setting (FS)	min	max	
13	Steam_actual_unit				Read value	Current steam output of the unit [4] in lbs/h
14	Steam_actual_cyl. 1				Read value	Current steam output [4] of cylinder 1 in lbs/h (for double cylinder units)
15	Steam_actual_cyl. 2				Read value	Current steam output [4] of cylinder 2 in lbs/h (for double cylinder units)
16	Steam_output_max.				Read value	Set value of maximum output power [43]
17	Demand				Read value	The demand [5] is the control signal from which the internal actuator signal [42] is created
18	Control_sig_internal				Read value	Internal actuator signal [42] as a percentage of the actuator signal for the nominal output
19	Output_signal				Read value	Output signal [69] on terminals 12, 13 proportional to input signal
20	Safety_interlock				Read value	Status of the interlock (Safety) system [11] 0 Off 1 On The interlock (safety) system is open The interlock (safety) system is closed
21	Safety_interlock_virtual				Read value	Status of the virtual interlock (safety) system [86] 0 Off 1 On The interlock (safety) system is open The interlock (safety) system is closed
22	Current_actual_cyl. 1				Read value	The current power consumption of cylinder 1 (only for ELDB [77])
23	Current_actual_cyl. 2				Read value	The current power consumption of cylinder 2 (only for ELDB [77] double cylinder units)
26	Water_level_cyl. 1				Read value	Water level in cylinder 1 in inch (only for HKDB [78])
27	Water_level_cyl. 2				Read value	Water level in cylinder 2 in inch (only for HKDB [78] double cylinder units)
28	Model				Read value	Type designation of unit
29	Unit_name				Read value	Unit name [90], can be selected by the customer, if required
30	Serial_number				Read value	Serial_number
31	Date_of_manufacturing				Read value	Date_of_manufacturing
32	Controller_series				Read value	Type of control
33	Software_version				Read value	Software version of control
34	Humidity_set_value				Read value	Set value [3] of rel. humidity [2] in %
35	Humidity_actual_value				Read value	Actual value [1] of rel. humidity [2] in %
36	Humidity_set_max				Read value	Set value [3] of rel. humidity [2] in % when floating max. limiter [35] is activated
37	Humidity_actual_max				Read value	Actual value [1] of rel. humidity [2] in % when floating max. limiter [35] is activated
48	Steam_amount_total_cyl. 1				Read value	Entire steam volume of cylinder 1 [lbs] produced since initial operation
49	Steam_amount_total_cyl. 2				Read value	Entire steam volume of cylinder 2 [lbs] produced since initial operation (double cylinder units only)
50	V_Signal				Read value	Voltage signal measured on terminal ST0805 (mainboard)
51	mA_Signal				Read value	Current signal measured on terminal ST0806 (mainboard)
52	Ω_Signal				Read value	Resistance signal measured on terminal ST0807 (mainboard)
53	Digital_input				Read value	Current state of digital input [97] on terminal ST0808 (mainboard) 0 Off 1 On No switching signal Switching signal present

5.6.3 History submenu



This submenu is identical on the user and the operator level.

5.6.3.1 Explanation of history management

The control stores 10 sets of error messages on a rolling basis. Once there are 10 records, the oldest record is overwritten by a current entry. An error message set consists of the following entries:

1. Date of error message
2. Contents of error message
3. Frequency of error message
4. Error origin

If an identical error occurs several times in a row, the first entry relating to this error is updated with the date of the most recent occurrence and the frequency is incremented. A new error message set is not recorded.

The situation is different if a particular error occurs multiple times, but not in direct succession. In this case, a new error message set is written for each instance.

Table of history layout

07: History

No.	Parameter	No.	Adjustment/value range Factory setting (FS) Bold min max FS	Meaning/Comment [] explains the term in the glossary ->[] refers to a related explanation of the term
1	1st fault_entry_date		Read value	1. Memory entry: Date/time
2	1st fault_entry_message		Read value	1. Memory entry: Fault message (for explanation see Read values 4 / Fault_m
3	1st fault_entry_rate		see: 02-1 Fault_message_unit Read value	1. Memory entry: Frequency of occurrence (since initial operation)
4	1st fault entry		Read value	1st memory entry: source of occurrence
		0	-	is not known
		1	Mainboard	is the motherboard
		2	Cylinder 1	is the steam cylinder 1
		3	Cylinder 2	is the steam cylinder 2
		10	Relay_extension 1	is the relay board 1
		11	Relay_extension 2	is the relay board 2
		12	Relay_extension 3	is the relay board 3
		13	Relay_extension 4	is the relay board 4
		20	Cylinder_extension 1	is the expansion board 1
		21	Cylinder_extension 2	is the expansion board 2
		22	Cylinder_extension 3	is the expansion board 3
		23	Cylinder_extension 4	is the expansion board 4

Table of history layout (ctd.)

5	2nd fault_entry_date		Read value	2. Memory entry: Date/time
6	2nd fault_entry_message		Read value	2. Memory entry: Error message, see above
7	2nd fault_entry_rate		see: 02-1 Fault_message_unit Read value	2. Memory entry: Frequency of occurrence (since initial operation)
8	2nd fault_entry		Read value	2nd memory entry: source of occurrence
9	3rd fault_entry_date		see: 07-4 1st fault entry Read value	3. Memory entry: Date/time
10	3rd fault_entry_message		Read value	3. Memory entry: Error message see above
11	3rd fault_entry_rate		see: 02-1 Fault_message_unit Read value	3. Memory entry: Frequency of occurrence (since initial operation)
12	3rd fault_entry		Read value	3rd memory entry: source of occurrence
13	4th fault_entry_date		see: 07-4 1st fault entry Read value	4. Memory entry: Date/time
14	4th fault_entry_message		Read value	4. Memory entry: Error message see above
15	4th fault_entry_rate		see: 02-1 Fault_message_unit Read value	4. Memory entry: Frequency of occurrence (since initial operation)
16	4th fault_entry		Read value	4th memory entry: source of occurrence
17	5th fault_entry_date		see: 07-4 1st fault entry Read value	5. Memory entry: Date/time
18	5th fault_entry_message		Read value	5. Memory entry: Error message see above
19	5th fault_entry_rate		see: 02-1 Fault_message_unit Read value	5. Memory entry: Frequency of occurrence (since initial operation)
20	5th fault_entry		Read value	5th memory entry: source of occurrence
21	6th fault_entry_date		see: 07-4 1st fault entry Read value	6. Memory entry: Date/time
22	6th fault_entry_message		Read value	6. Memory entry: Error message see above
23	6th fault_entry_rate		see: 02-1 Fault_message_unit Read value	6. Memory entry: Frequency of occurrence (since initial operation)
24	6th fault_entry		Read value	6th memory entry: source of occurrence
25	7th fault_entry_date		see: 07-4 1st fault entry Read value	7. Memory entry: Date/time
26	7th fault_entry_message		Read value	7. Memory entry: Error message see above
27	7th fault_entry_rate		see: 02-1 Fault_message_unit Read value	7. Memory entry: Frequency of occurrence (since initial operation)
28	7th fault_entry		Read value	7th memory entry: source of occurrence
29	8th fault_entry_date		see: 07-4 1st fault entry Read value	8. Memory entry: Date/time
30	8th fault_entry_message		Read value	8. Memory entry: Error message see above
31	8th fault_entry_rate		see: 02-1 Fault_message_unit Read value	8. Memory entry: Frequency of occurrence (since initial operation)
32	8th fault_entry		Read value	8th memory entry: source of occurrence
33	9th fault_entry_date		see: 07-4 1st fault entry Read value	9. Memory entry: Date/time
34	9th fault_entry_message		Read value	9. Memory entry: Error message see above
35	9th fault_entry_rate		see: 02-1 Fault_message_unit Read value	9. Memory entry: Frequency of occurrence (since initial operation)
36	9th fault_entry		Read value	9th memory entry: source of occurrence
37	10th fault_entry_date		see: 07-4 1st fault entry Read value	10. Memory entry: Date/time
38	10th fault_entry_message		Read value	10. Memory entry: Error message see above
39	10th fault_entry_rate		see: 02-1 Fault_message_unit Read value	10. Memory entry: Frequency of occurrence (since initial operation)
40	10th fault_entry		Read value	10th memory entry: source of occurrence
41	Clear_memory		see: 07-4 1st fault entry Selection	Reset error messages?
		0	Off	No
		1	On	Yes

5.7 Screen 3 - Main menu (operator level)

After the operator level has been selected by entering the corresponding password (code 010), the main menu is displayed. It spans multiple screen pages and scroll keys are used to navigate between them.

Screen page 1 (of 3)

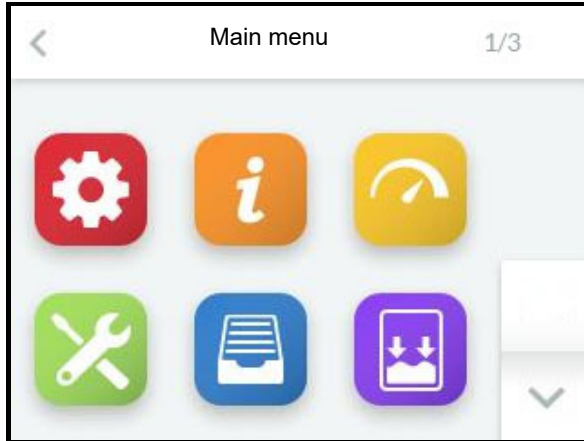

Screen page 2

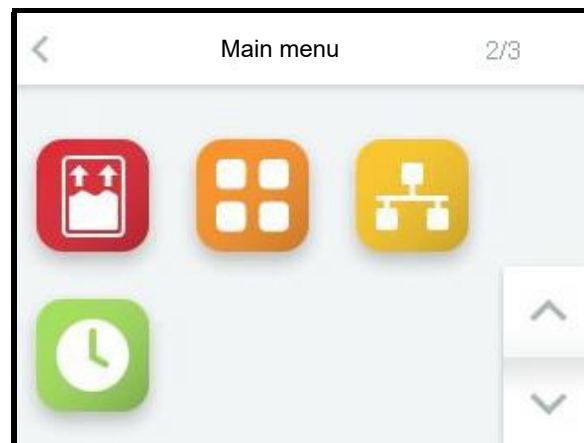

Screen page 3

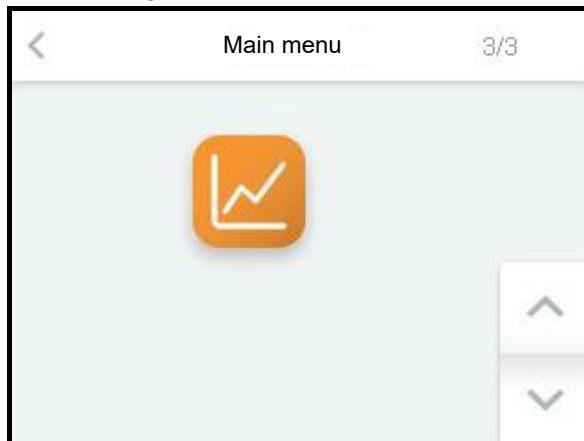

5.8 Operator level submenus

By touching the respective icon, the operator accesses the screen page where the parameters of the respective group are available for selection, viewing or for making changes. The layout of the screen pages corresponds to the pages of the submenus of the user level (see Section 5.6).

Icon	Selection of submenu
	Settings
	Read values
	Control
	Service
	History
	Blow-down
	Filling
	Functions
	Communication interface
	Weekly timer
	Recording
	Cylinder extension (visible only if an extension board is present)
	Relay extension 1 (visible only if a relay board is present)
	Relay extension 2 (visible only if 2nd relay board is present)

The parameters available in the submenus are described in table form below (for explanations on the individual parameters see Glossary in Section 8).

5.8.1 Settings submenu



Table of settings parameters (operator level)

03: Settings

No.	Parameter	No.	Adjustment/value range			Meaning/Comment
			Factory setting (FS)	Bold		
			min	max	FS	
1	Language		Selection			Selection of language
			see: 01-1 Language			
2	Date		DD.MM.YY			Set date
3	Time_of_day		HH:MM			Set time
4	Display_lighting_normal		5	100	100	Screen backlight in undimmed state
5	Delay_present_page		0	3600	300	Display duration for a certain screen page before return to the main screen in min
6	Display_lighting_dimmed		0	100	50	Screen brightness for dimmed state
7	Display_dim_after		0	3600	120	Switching of screen brightness of main screen to dimmed value after ... seconds. If an error has occurred or a status message is displayed, the main screen is not dimmed
8	Units		Selection			Selection of system of units
		0	SI			Units are displayed in the format of the SI system of units [8]
		1	Imperial			Units are displayed in the format of the imperial system of units [9]

5.8.2 Read values submenu



The read value submenu is no different to that of the user level. The read values listed in table format in Section 5.6. are also available at the operator level.

5.8.3 Control submenu



Table of control parameters

05: Control

No.	Parameter	No.	Adjustment/value range			Meaning/Comment [] explains the term in the glossary → [] refers to a related explanation of the term
			Factory setting (FS)	Bold	min max FS	
1	Control_settings		Selection see: 01-4 Control_settings			Combinations of control type and input signal type/range
2	Steam_output_max.		25.0	100.0	100.0	The maximum output power [43] can be limited to between 25 and 100%
3	Δ Power_limitation		0	50.0	0	Reduction of the maximum steam output for the purpose of load shedding [101]
4	Output_signal		Selection			Mapping of the output signal [69] to an internal value
		0	Off			No mapping
		1	Control_sig_external			Output signal is proportional to the demand [5] from the external controller [73]
		2	Control_sig_internal			Output signal is proportional to the internal actuator signal [42]
		3	Humidity_actual_value			Output signal is proportional to the actual humidity value [1]
		4	Control_signal_slave			Output is used to control a slave [94]
17	Humidity_set_value		0	99.0	50.0	Set value [3] of RH [2] in %
18	Δ Set_value_dehumidification		1.0	20.0	10.0	Downstream dehumidifier is actuated if humidity set value has been exceeded by the respective difference value [%], (PI controller only), → [50]
19	Δ Humidity_ECO		0	50.0	10.0	Target humidity is lowered by this percentage when ECO is switched on
20	PI-controller_gain		.5	100.0	5.0	Proportional part of PI controller
21	PI-controller_integral		0	100	10	Integral part of PI controller
22	Humidity_notification		5.0	99.0	50.0	When the set humidity [%] has been reached, one of the relays is energised, which must have been assigned code 211 (humidity reached) for this purpose
23	Humidity_set_max		5.0	99.0	80.0	Specification of max. humidity for the switch-off point when using the floating max. limiter [35]
24	Pi-controller_max_gain		.5	100.0	5.0	Amplification of 2nd PI controller when using the floating max. limiter [35]

5.8.4 Service submenu



5.8.4.1 Monitoring and service messages

The wear components of the unit and the status of the steam cylinder(s) are monitored continuously when the unit is in operation. When a limit value is reached, the corresponding service message is displayed with reference to the cylinder. The service messages need to be reset after component replacement or cylinder maintenance.

The following service messages are implemented:

Steam volume

A steam volume in kg is specified in the "Steam_volume_service" parameter and after this is reached, the message "Steam volume counter" is issued. In case of double cylinder units, the parameter entry applies to both cylinders. The service message differentiates between cylinder 1 and cylinder 2.

After the service has been carried out, the message has to be reset with "Reset_cyl. 1" or "Reset_cyl. 2" (or both).

For the assessment of the remaining steam volume until the next service is required, the read values "Steam_volume_to_service_cyl. 1" and "Steam_volume_to_service_cyl. 2" (only for double cylinder units) are used.

Main contactors

For main contactors, the maximum number of operating cycles is specified by the manufacturer. When a limit value is reached, the corresponding service message is displayed. The main contactor must then be changed and the message has to be reset by setting the "Main_contactor Kx_Reset" (x = 1...5) parameter.

Please note

When the service message was triggered for one of the main contactors, it is advisable to check the meter reading for the remaining main contactors.

Monitoring

The FlexLine control permanently monitors the performance capabilities of the electrodes (ELDB only), of the blow-down pump(s), and of the solenoid valve(s). When preset functionality warning thresholds are exceeded, messages are generated with respect to the current state of:

- Electrodes (ELDB only), („Warning_cyl._full“)
- Blow-down pump(s) („Warning_pump“)
- Solenoid valve(s) („Warning_valve“)

Three sensitivity values can be selected for each of the alarm thresholds, where "Sensitivity 3" triggers the warning messages at the earliest time.

After the condition for triggering the warning has been resolved (e.g. by cleaning the solenoid valve intake strainer), no further warning is issued. The warning messages can also be turned off (s. parameters 22, 23 and 24 in the table following hereunder).

Table of service parameters

06: Service

No.	Parameter	No.	Adjustment/value range			Meaning/Comment [] explains the term in the glossary → [] refers to a related explanation of the term
			min	max	FS	
2	Steam_amount_service		0	65535	0	Preset steam volume (see [33]) in short ton. until service message is triggered
4	Service-reset_cyl. 1		Selection			Reset steam volume counter for cylinder 1 →[33]
		0	Off			No
		1	On			Yes
6	Steam_until_msg_cyl. 1		Read value			Remaining steam volume for cyl. 1 in lbs until service message →[33] is triggered
7	Service-reset_cyl. 2		Selection			Reset steam volume counter for cylinder 2 →[33], double cylinder units only
		0	Off			No
		1	On			Yes
9	Steam_until_msg_cyl. 2		Read value			Remaining steam volume for cyl. 2 in lbs until service message →[33] is triggered
12	Main_contactor 1_reset		Selection			Reset K1 counter for main contactor operating cycles →[34]
		0	Off			No
		1	On			Yes
13	K1_switching_cycles_until_msg.		Read value			Remaining operating cycles for K1 until service message →[34] is triggered
14	Main_contactor 2_reset		Selection			Reset K2 counter for main contactor operating cycles →[34]
		0	Off			No
		1	On			Yes
15	K2_switching_cycles_until_msg.		Read value			Remaining operating cycles for K2 until service message →[34] is triggered
16	Main_contactor 3_reset		Selection			Reset K3 counter for. main contactor operating cycles →[34] (double cyl. units only)
		0	Off			No
		1	On			Yes
17	K3_switching_cycles_until_msg.		Read value			Remaining operating cycles for K3 until service message →[34] is triggered
18	Main_contactor 4_reset		Selection			Reset K4 counter for main contactor operating cycles →[34] (double cyl. units only)
		0	Off			No
		1	On			Yes
19	K4_switching_cycles_until_msg.		Read value			Remaining operating cycles for K4 until service message →[34] is triggered
20	Main_contactor 5_reset		Selection			Reset K5 counter for main contactor operating cycles →[34] (double cyl. units only)
		0	Off			No
		1	On			Yes
21	K5_switching_cycles_until_msg.		Read value			Remaining operating cycles for K5 until service message →[34] is triggered
22	Warning_cyl_full		Selection			Warning message about electrode burn-off (only for ELDB [77]) →[95]
		0	Off			No message
		1	Sensitivity 1			Threshold value 1 for message (lowest sensitivity)
		2	Sensitivity 2			Threshold value 2 for message (medium sensitivity)
		3	Sensitivity 3			Threshold value 3 for message (highest sensitivity)
23	Warning_pump		Selection			Warning message about functional performance of blow-down pump →[95]
		see: 06-22 Warning_cyl_full				
24	Warning_valve		Selection			Warning message about functional performance of solenoid valves →[95]
		see: 06-22 Warning_cyl_full				
26	Update_function		Read value			Status of update function [7]
		0	USB-stick_insert			USB stick is not inserted
		1	Loading			The parameter set which is saved on the stick is loaded
		2	Checking			The loaded parameter set is checked
		3	Update			The parameter set is updated
		4	Successful			The update was successful
		5	Data_not_valid			USB stick does not contain a parameter set or parameter set is not compatible

5.8.4.2 Procedure for parameter update

The information below explains how to work with the "Update_function" parameter (see parameter row 26 in the table above).

The update function makes it possible to overwrite parameter settings with a parameter set which is saved on an external USB flash drive. As a result, the operator can make a change without having to change the parameters by themselves. The modified parameter set can be provided by HygroMatik.

The procedure is as follows:

- » With the unit switched on, insert the USB stick into the socket on the mainboard.
- » Call up the "Update function" in the services submenu.

The status of the update process is displayed (see table). Its successful completion is displayed by the "Update successful" status message.

- » Switch the unit off and on again. The loaded parameter set is activated.
- » To reload the parameter set at a later date if required (e.g. after a factory reset), the "ImportDone.txt" file on your USB stick must be deleted beforehand. To do so, the stick must be inserted in an external device (e.g. PC).

If the status "Invalid data" is output after the update operation, a compatible parameter set is not available on the USB stick.

USB connector on mainboard

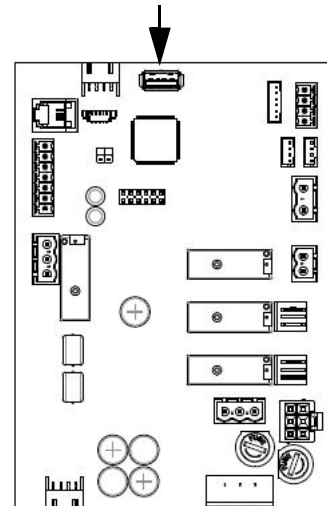

5.8.5 History submenu



The error message history was already described for the user level in Section 5.6.3. There are no differences at the operator level.

5.8.6 Blow-down submenu



Table of blow-down parameters

08: Blow-down

No.	Parameter	No.	Adjustment/value range			Meaning/Comment [] explains the term in the glossary → [] refers to a related explanation of the term
			min	max	FS	
1	Full_blow-down_correction		-5	5	0	Correction value for frequency of full blow-down ("+" = more frequently, "-" = less frequently) → [55]
2	Part_blow-down_correction		-5	5	0	Correction value for frequency of partial blow-down ("+" = more frequently, "-" = less frequently) → [55]
3	Standby_blow-down		Selection			Full blow-down [58] for hygiene reasons, if there was no steam production for an extended period → [26]
		0	Deactivated			No stand-by blow-down
		1	Activated			Blow-down after waiting period
4	Standby_blow-down_interval		1	2880	1440	After the waiting period specified, the remaining water is pumped off if the interlock (safety) system [11] was opened during this period of time, i.e. no steam production took place → [26]
5	Blow-down_without_K1		Selection			Pumps without main contactor [75] in order to avoid triggering of residual current detector → [56]
		0	Deactivated			Main contactor [75] switched on during pumping
		1	Activated			Main contactor [75] switched off during pumping

5.8.7 Fill parameters submenu



Table of fill parameters

09: Filling

No.	Parameter	No.	Adjustment/value range			Meaning/Comment [] explains the term in the glossary →[] refers to a related explanation of the term
			min	max	FS	
1	Filling_pulsed		Selection			The filling process is not continuous, but intermittent →[54] Activated Not activated
		0	Deactivated			
		1	Activated			
2	Filling_pulsed_interval		1	10	2	Time interval in s, during which filling does not take place (filling pause)
3	Filling_pulsed_active		1	600	10	Duration of filling time in s until filling pause

5.8.8 Functions submenu



Table of function parameters

10: Functions

No. Parameter	No.	Adjustment/value range			Meaning/Comment [] explains the term in the glossary →[] refers to a related explanation of the term
		Factory setting (FS)	Bold	FS	
1 Standby-heating		Selection			The standby heating [16] keeps the water in the cylinder warm if no demand [5] is present Standby heating [16] switched off Standby heating [16] switched on
	0	Deactivated			
	1	Activated			
2 Standby-heating_interval		1	999	1	Pause time of standby heating [min]
3 Standby-heating_active		1	999	1	Heating time of standby heating [16] [s]
4 Dead_leg_flushing		Selection			The solenoid valves of the water input and blow-down pump are switched on and off simultaneously with the flushing of the dead-end line [27] Flushing of dead-end line [27] is not carried out Facilitate flushing of dead-end line [27]
	0	Deactivated			
	1	Activated			
5 Dead_leg_flushing_interval		1	5760	1440	Waiting period until start of flushing of dead-end line [27] [min]
6 Dead_leg_flushing_active		1	600	90	Duration of flushing of dead-end line [27] [s]
7 Runtime_limitation		0	1440	0	Steam production is stopped after the time interval specified [min]; for resumption →[32]
8 Weekly_timer		Selection			Activation of weekly timer Steam production runs continuously with the parameters preset Steam is generated in accordance with the settings made in the Weekly timer submenu →[91]
	0	Off			
	1	On			
9 Timer_mode		Selection			The timer function [18] is triggered with an external button The timer function [18] is not available Steam production stops after the timer has elapsed The unit reverts to ECO mode [61] after the timer has elapsed
	0	Off			
	1	Steam_off			
	2	ECO			
10 Timer_running_time		0	65535	0	The runtime of the timer is given in seconds
11 Password_remote		0	9999	0	Storage of a password with a maximum of 4 digits for remote access via the communication interface, input using the keyboard screen
12 Function_digital_input		Selection			Mapping of digital input function [98] to mainboard Not used Activated digital input [97] by a pushbutton [106] switches ECO mode on Activated digital input [97] by a pushbutton [106] starts timer function [18] Activated digital input [97] by a switch (NO) switches power limitation on for load shedding [101]
	0	Off			
	10	ECO			
	30	Timer_start			
	40	Power_limitation			
14 Control_curve		Selection			Behaviour during cold start or specification for special applications (only ELDB [77]), see [68] Current during cold start is 128% of rated current for fast heating Current during cold start is 113% of the nominal current, to avoid overloading the supply network despite fast heating Particularly fine control for critical applications
	0	Energie-optimized			
	1	Load-optimized			
	2	Process-optimized			
15 Delay_humidificat_notif.		0	3600	60	Delay of Humidifying message in secs (see [74])
16 Assignment_main_relay		Selection			The relay is energised for a message (M) or a switching function (S), if ... There is any kind of error (M) The interlock (safety) system [11] is open (M) No demand [5] is present (M) Steam production is in progress (M) The unit has switched off steam production after the limitation of operating time was reached [32] (M) A remote shutdown was carried out via software command [12] (M) The interlock (safety) system [11] is switched via an additional relay (M) The interlock (safety) system [11] is switched as standard (M) A dropout delay [74] is to be generated following humidification (S) the timer function has stopped the steam production (M) the weekly timer has stopped the steam production (M) None of the solenoid valves are actuated (M) One of the solenoid valves is actuated (M) Solenoid valve 1 is actuated (M) Solenoid valve 2 is actuated (M) The superflush SV is switched via the contacts of this relay
	0	Collective_fault			
	1	Safety_interlock_open			
	2	No_Demand			
	3	Humidification			
	4	Runtime_limitation			
	5	Remote_off			
	6	Safety_interlock_ELV			
	7	Safety_interlock_closed			
	8	Humidification_off_delay			
	9	Timer_steam_off			
	10	Weekly_timer_steam_off			
	30	Solenoid_valves_off			
31	Solenoid_valves_on				
32	Solenoid_valve 1				
33	Solenoid_valve 2				
36	HyFlush				

Function parameters (ctd.)

No. Parameter	No.	Adjustment/value range			Meaning/Comment [] explains the term in the glossary →[] refers to a related explanation of the term
		Factory setting (FS)	Bold	FS	
	60	Pump_off			The blow-down pump is not actuated (M)
	61	Pump_on			The blow-down pump is actuated (M)
	62	Part_blow-down			A partial blow-down [21] is taking place (M)
	63	Full_blow-down			A full blow-down [22] is taking place (M)
	64	Dilution			A dilution [23] is taking place (only for ELDB [77]) (M)
	65	Max_current_blow-down			An overcurrent blow-down [24] is taking place (only for ELDB [77]) (M)
	66	Max_level_blow-down			A max. level blow-down [25] is taking place (only for HKDB [78]) (M)
	67	Standby_blow-down			A standby blow-down [26] is taking place (M)
	68	Dead_leg_flushing			An additionally installed relay is to be actuated, which switches the input solenoid valve for flushing the dead-leg line if the interlock (safety) system is not closed (S)
	69	Start_blow-down			A start blow-down [20] is taking place (M)
	120	Cylinder_1_step_1			Power level [63] 1 of cylinder 1 is active (only for HKDB [78]) (S). If this assignment was chosen ex-factory, no other assignment is possible.
	121	Cylinder_1_step_2			Power level [63] 2 of cylinder 1 is active (only for HKDB [78]) (S). If this assignment was chosen ex-factory, no other assignment is possible.
	122	Cylinder_2_step_1			Power level [63] 1 of cylinder 2 is active (only for HKDB double cylinder units) (S). If this assignment was chosen ex-factory, no other assignment is possible.
	123	Cylinder_2_step_2			Power level [63] 2 of cylinder 2 is active (only for HKDB double cylinder units) (S). If this assignment was chosen ex-factory, no other assignment is possible.
	210	Dehumidification			A downstream dehumidifier is to be actuated →[50] (S)
	211	Humidity_reached			The value set in the Control 21 parameter (Humidity_notification) has been reached (M)
	270	Collective_service			A general service message is generated (M)
	271	Service_solenoid_valve			A service for one of the solenoid valves or the water supply line is required
	272	Service_blow-down_pump			A service for the blow-down pump is required (M)
	273	Service_steam_amount_cnt.			A service is required after the steam volume counter which is relevant for the service was reached (M)
	274	Service_main_contactor K1			A service is required after the max. operating cycles for K1 have been reached (M)
	275	Service_main_contactor K2			A service is required after the max. operating cycles for K2 have been reached (only for double cylinder units) (M)
	276	Service_main_contactor K3			A service is required after the max. operating cycles for K3 have been reached (only for double cylinder units) (M)
	277	Service_main_contactor K4			A service is required after the max. operating cycles for K4 have been reached (only for double cylinder units) (M)
	278	Service_main_contactor K5			A service is required after the max. operating cycles for K5 have been reached (only for double cylinder units) (M)
17	Assignment_relay K20	Selection			Relay K20 is one of the top-hat rail relays connected to the ST10.1 connector on the mainboard; assignment is same as for base relay
		see: 10-16 Assignment_main_relay			
18	Assignment_relay K21	Selection			Relay K21 is the second of the top-hat rail relays connected to the ST10.2 connector on the mainboard; assignment is same as for base relay
		see: 10-16 Assignment_main_relay			
19	Assignment_relay K22	Selection			Relay K22 is one of the top-hat rail relays connected to the ST10.2 connector on the mainboard; assignment is same as for base relay
		see: 10-16 Assignment_main_relay			
20	Assignment_relay K23	Selection			Relay K23 is the second of the top-hat rail relays connected to the ST10.2 connector on the mainboard; assignment is same as for base relay
		see: 10-16 Assignment_main_relay			

Relays K20 to K23/ Relay assignment ex works:

If no built-in options are available ex works, only contact ST03 on the basic relay is assigned the "collective fault" function. All other contacts are assigned the switching message "Not used".

5.8.9 Communication interface sub-menu



The communication interface is a serial RS285 computer interface for the remote control of the steam humidifier. With this computer interface, all control operations which can be carried out on the screen can also be carried out by the building technology control system, for example.

The MODBUS-RTU Protocol is used to transmit the control commands (separate documentation on this is available from HygroMatik).

Table of communication interface parameters

11: Communication

No. Parameter	No.	Adjustment/value range			Meaning/Comment [] explains the term in the glossary → [] refers to a related explanation of the term
		min	max	FS	
1 Address		0	255	1	Address of the communication interface [13]
2 Baud_rate		Selection			Setting the baud rate
	0	1200			1200
	1	2400			2400
	2	4800			4800
	3	9600			9600
	4	19200			19200
	5	28800			26800
	6	38400			38400
	7	57600			57600
3 Parity		Selection			Parity setting
	0	None			Without parity bit
	1	Odd			Odd parity bit
	2	Even			Even parity bit
4 Stop_bits		Selection			Number of stop bits
	0	1			1 stop bit
	1	2			2 stop bits
5 Modbus_timeout		0	60	20	Timeout in s for software control commands [12] through communication interface [13]

5.8.10 Weekly timer submenu

The weekly timer is used to program two switching time ranges per day of the week, each defined by "Start time" and "End time". A humidity target value can be assign to each switching time range.

The activation of the timer can be carried out in the "Functions" submenu using parameter no. 8 ("Weekly timer"). The setting options are "On" and "Off".

Please note

When operating the control using the internal PI-controller and in weekly timer mode, the display of the temperature set value in the main display disappears during normal steam generation. In ECO mode, however, the set value specification remains visible.

Table of "Weekly timer" parameters

12: Weekly_timer

No.	Parameter	No.	Adjustment/value range			Meaning/Comment [] explains the term in the glossary →[] refers to a related explanation of the term
			min	max	FS	
1	Mon_start_time 1		00:00	23:59	08:00	Start time 1 for Monday (1st period) →[91]
2	Mon_stop_time 1		00:00	23:59	12:00	End time 1 for Monday
5	Mon_humidity_set_value 1		5.0	99.0	50.0	Humidity set value [% RH] for the 1st period on Monday
6	Mon_start_time 2		00:00	23:59	13:00	Start time 2 for Monday (2nd period) →[91]
7	Mon_stop_time 2		00:00	23:59	20:00	End time 2 for Monday
10	Mon_humidity_set_value 2		5.0	99.0	50.0	Humidity set value for the 2nd period on Monday

The table only shows the possible parameter settings for Monday. The paramters for the rest of the weekdays (Tuesday to Sunday) can be programmed in the same way.

5.8.11 Recording submenu



The control can record 10 data sets internally on a rolling basis (Recording submenu, parameter 1 set to „On“). Snapshots of the unit status are carried out at intervals of 10 s, which can be helpful for troubleshooting. When all memory slots are filled, a new set of data overrides the oldest entry. A recorded set of data is conserved for a period of max. 7 days.

The complete record [93] can be saved to a USB stick with FAT32 formatting.

For saving, pls. proceed as follows:

- » Call up recording submenu.
- » Insert USB stick in connector on mainboard (s. drawing below).
- » Set parameter „Saving_start“ (2) to „On“. Saving starts automatically. Then, parameter „Saving_start“ returns to the „Off“-state.

USB connector on mainboard

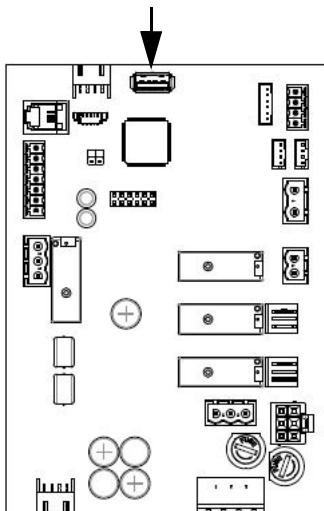

By looking at parameter „Saving_status“ (4) the status of the saving procedure can be checked. „Activated“ means that writing to the memory stick is underway.

Erasing of the complete memory is achieved by setting the „Recording_delete“ parameter (5) to „On“.

Please note

During the erasing of the recording memory, the display possibly shows a „?“ since no access to the unit parameters is made.

A data set consists of the following values:

No.	Value	only
1	Steam_actual_unit	
2	Steam_actual_Cyl. 1	DZG
3	Steam_actual_Cyl. 2	DZG
4	Status_unit	
5	Status_cyl. 1	
6	Status_cyl. 2	DZG
7	Fault message_unit	
8	Fault message_cyl. 1	
9	Fault message_cyl. 2	DZG
10	Safety interlock_open	
11	Demand	
12	Steam_output_max.	
13	Current_actual_Cyl. 1	ELDB
14	Current_actual_Cyl. 2	ELDB DZG
15	Water_level_cyl. 1	HKDB
16	Water_level_cyl. 2	HKDB DZG
17	Humidity_actual value	
18	Humidity_set value	
19	Humidity_actual_value_max	MB
20	Humidity_set_value_max	MB

Legend:

- ELDB = Electrode Steam Humidifier
- HKDB = Heater Element Steam Humidifier
- DZG = Double Cylinder Unit
- MB= Variable Max. Limitation

Table of recording functions

16: Recording

No.	Parameter	No.	Adjustment/value range Factory setting (FS) Bold min max FS	Meaning/Comment [] explains the term in the glossary → [] refers to a related explanation of the term
1	Recording		Selection	Recording [93] of parameter sets
		0	Deactivated	No recording
		1	Activated	Start recording
2	Saving_start		Selection	Saving of the existing recording on a USB stick
		0	Off	No action
		1	On	Start saving process
3	Saving_abort		Selection	Cancel saving
		0	Off	No action
		1	On	Cancel saving process
4	Saving_status		Read value	Status of saving process
		0	Deactivated	Saving not possible
		1	Activated	Saving is enabled
5	Recording_delete		Selection	Delete recording
		0	Off	No action
		1	On	Delete recording

5.8.12 Cylinder extension submenu



The icon is only visible in the main menu if a cylinder extension board is present.

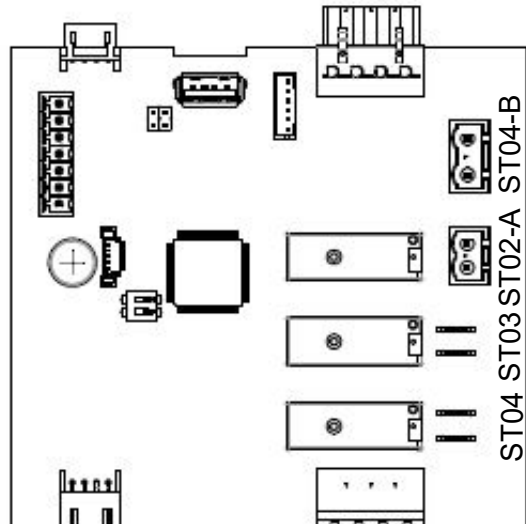

Table of control input parameters

17: Cylinder extension

No.	Parameter	No.	Adjustment/value range			Meaning/Comment [] explains the term in the glossary ->[] refers to a related explanation of the term
			Factory setting (FS)	Bold	FS	
1	Digital_input_function		Selection			Assignment of the digital input function [98] of the digital input [97] on the cylinder extension board
8	V_Signal		see: 10-12	Function_digital_input	Read value	Voltage signal measured on terminal ST0505
9	V_Signal_%				Read value	Processed input signal corresponding to measured voltage signal on terminal ST0505 [%]
10	mA_Signal				Read value	Current signal measured on terminal ST0506
11	mA_Signal_%				Read value	Processed input signal corresponding to measured current signal on terminal ST0506 [%]
12	Ω_Signal				Read value	Resistance signal measured on terminal ST0507
13	Ω_Signal_%				Read value	Processed input signal corresponding to measured resistance signal on terminal ST0507 [%]
14	°C-Signal				Read value	Temperature signal measured on terminal ST0507
15	Digital_input				Read value	Current state of digital input [97] on terminal ST0508
		0	Off			No switching signal
		1	On			Switching signal present

5.8.13 Relay extension 1 submenu



The icon is only visible in the main menu if relay extension 1 has been activated in the functions submenu. The assignment of the respective relays and the function definition of the digital input present on the relay card can be made here.

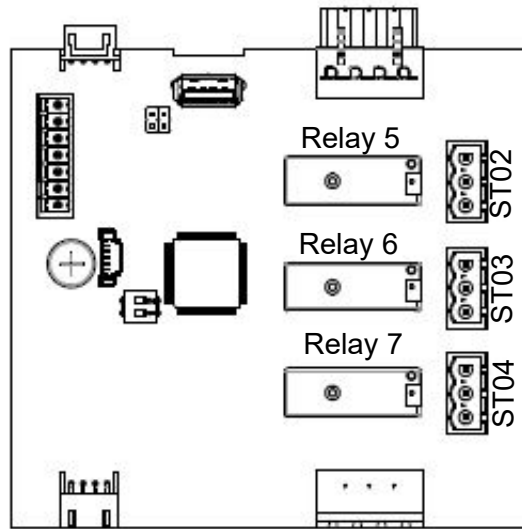

Relay designations on relay extension 1 p.c.b.

Table of control input parameters and possible relay assignments

18: Relay_extension 1

No.	Parameter	No.	Adjustment/value range			Meaning/Comment [] explains the term in the glossary → [] refers to a related explanation of the term
			Factory setting (FS)	min	max	
1	Assignment_relay ST02		Selection			Occupancy selection as for basic relay (see submenu "Functions", 16)
2	Assignment_relay ST03		Selection	see: 10-16 Assignment_main_relay		Occupancy selection as for basic relay (see submenu "Functions", 16)
3	Assignment_relay ST04		Selection	see: 10-16 Assignment_main_relay		Occupancy selection as for basic relay (see submenu "Functions", 16)
4	Digital_input_function		Selection	see: 10-16 Assignment_main_relay		Mapping of the digital input function [98] to relay board 1
11	V_Signal		Read value	see: 10-12 Function_digital_input		Voltage signal measured on terminal ST0505
12	V_Signal_%		Read value			Processed input signal corresponding to measured voltage signal on terminal ST0505 [%]
13	mA_Signal		Read value			Current signal measured on terminal ST0506
14	mA_Signal_%		Read value			Processed input signal corresponding to measured current signal on terminal ST0506 [%]
15	Ω_Signal		Read value			Resistance signal measured on terminal ST0507
16	Ω_Signal_%		Read value			Processed input signal corresponding to measured resistance signal on terminal ST0507 [%]
17	°C-Signal		Read value			Temperature signal measured on terminal ST0507
18	Digital_input		Read value			Current state of digital input [97] on terminal ST0508
		0	Off			No switching signal
		1	On			Switching signal present

5.8.14 Relay extension 2 submenu



The icon is only visible in the main menu if relay extension 2 has been activated in the functions submenu. The assignment of the respective relays and the function definition of the digital input present on the relay card can be made here.

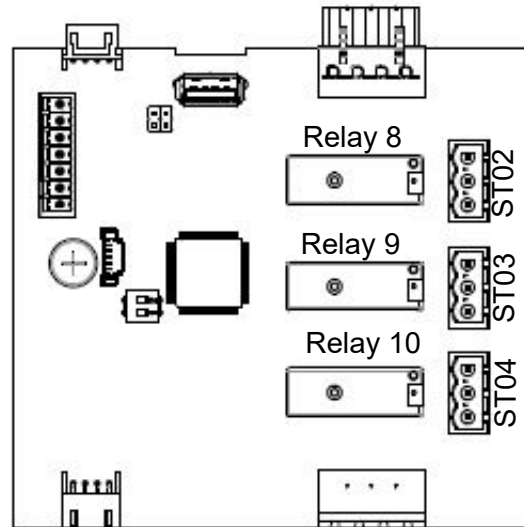

Relay designations on relay extension 2 p.c.b.

Table of control input parameters and possible relay assignments

19: Relay_extension 2

No.	Parameter	No.	Adjustment/value range			Meaning/Comment [] explains the term in the glossary -> [] refers to a related explanation of the term
			Factory setting (FS)	Bold	min max FS	
1	Assignment_relay ST02		Selection			Occupancy selection as for basic relay (see submenu "Functions", 16)
2	Assignment_relay ST03		Selection		see: 10-16 Assignment_main_relay	Occupancy selection as for basic relay (see submenu "Functions", 16)
3	Assignment_relay ST04		Selection		see: 10-16 Assignment_main_relay	Occupancy selection as for basic relay (see submenu "Functions", 16)
4	Digital_input_function		Selection		see: 10-12 Function_digital_input	Mapping of the digital input function [98] to relay board 1
11	V_Signal				Read value	Voltage signal measured on terminal ST0505
12	V_Signal_%				Read value	Processed input signal corresponding to measured voltage signal on terminal ST0505 [%]
13	mA_Signal				Read value	Current signal measured on terminal ST0506
14	mA_Signal_%				Read value	Processed input signal corresponding to measured current signal on terminal ST0506 [%]
15	Ω_Signal				Read value	Resistance signal measured on terminal ST0507
16	Ω_Signal_%				Read value	Processed input signal corresponding to measured resistance signal on terminal ST0507 [%]
17	°C-Signal				Read value	Temperature signal measured on terminal ST0507
18	Digital_input				Read value	Current state of digital input [97] on terminal ST0508
		0	Off			No switching signal
		1	On			Switching signal present

5.9 Screen 4 - Unit information

After an error or a status message has occurred, a display which provides information about the type of message appears in the main screen instead of the HygroMatik logo. The content of the message is described in Section 6.

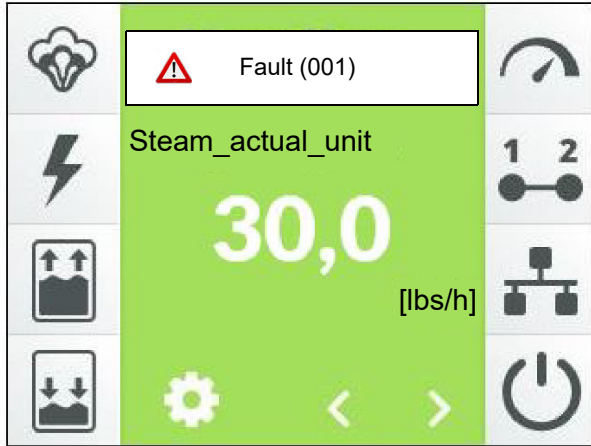

Touching this display field calls up the unit info screen which extends over several screen pages and contains comprehensive device data. As an example, one possible first screen page is shown here:

< 02: Information	
01: Error message_unit	
Plug_ST09	
02: Error_message_cyl. 1	
Plug_ST09	
04: Service_message_cyl. 1	
No_service_message	
06: Unit type	
FLE20-AA10	
	v

The content of the screen pages is provided in the table in the next section.

Entries on the unit info screen

02: Information

No. Parameter	No.	Adjustment/value range Factory setting (FS) Bold min max FS	Meaning/Comment [] explains the term in the glossary ->[] refers to a related explanation of the term
1 Fault_message_unit			Read value List of possible unit fault messages
	0	No_fault	No fault
	1	Plug_ST09	The plug for the current transformer (ELDB) [77] or the level control (HKDB) [78] is not attached
	2	Cylinder_extension 1	
	6	Relay_extension 1	There is a problem with relay board 1
	7	Relay_extension 2	There is a problem with relay board 2
	22	Input_current_min.	Minimum value of current input not plausible
	24	Input_resistance_OC	Minimum value of resistance input/NTC input not plausible
	25	Input_resistance_SC	Maximum value of resistance input/NTC input not plausible
	29	Internal	System fault
	30	Filling_valve 1	Fault solenoid valve 1 [19]
	32	Filling_valve 1 a. 2	Fault solenoid valve 1 and solenoid valve 2 [19]
	61	Part_blow-down	Partial blow-down [21] not successful
	62	Full_blow-down	Full blow-down [22] was not successful
	63	Blow-down_dilution	Dilution [23] was not successful (only for ELDB [77])
	64	Max_current_blow-down	Overcurrent blow-down [24] was not successful (only for ELDB [77])
	65	Max_level_blow-down	Max. level blow-down [25] was not successful (only for HKDB [78])
	66	Standby_blow-down	Stand-by blow-down [26] was not successful
	67	Start_blow-down	Start blow-down [20] not successful
	90	Cylinder_full	Sensor electrode reports cylinder full status [38] for over 60 min (only for ELDB [77])
	91	Current_measurement	Value provided by current measurement not plausible (only for ELDB [77])
	92	Main_contactor_current	A current is measured for at least 15 s, even though the main contactor [72] is not actuated (only for ELDB [77])
	93	Main_contactor_cyl_full	A cylinder full status [38] was detected for at least 15 s, even though the main contactor [72] is not actuated (only for ELDB [77])
	120	Thermoswitch	A thermo sensor [31] has been triggered (only for HKDB [78])
	121	Water_level_sensor	Value provided by level control [39] not plausible (only for HKDB [78])
	122	Max.-level	Max. level [40] was reached 5 times in a row during filling (only for HKDB [78])
	123	Steam_down_time	Despite a current feed to the radiators, the water level has not changed in the period specified ->[53] (only for HKDB [78])
	124	Relay_main_contactor	The relay for the control of the main contactor is not functioning correctly
	210	Humidity_sensor	Humidity sensor, cable or input level defective
	211	Humidity_sensor 2	Humidity sensor 2, cable or input level defective
2 Fault_message_cyl. 1			Read value List of possible fault messages for cylinder 1 (see Fault_message_unit)
	0	No_fault	No fault
	1	Plug_ST09	The plug for the current transformer (ELDB) [77] or the level control (HKDB) [78] is not attached
	29	Internal	System fault
	30	Filling_valve 1	Fault solenoid valve 1 [19]
	32	Filling_valve 1 a. 2	Fault solenoid valve 1 and solenoid valve 2 [19]
	61	Part_blow-down	Partial blow-down [21] not successful
	62	Full_blow-down	Full blow-down [22] was not successful
	63	Blow-down_dilution	Dilution [23] was not successful (only for ELDB [77])
	64	Max_current_blow-down	Overcurrent blow-down [24] was not successful (only for ELDB [77])
	65	Max_level_blow-down	Max. level blow-down [25] was not successful (only for HKDB [78])
	66	Standby_blow-down	Stand-by blow-down [26] was not successful
	67	Start_blow-down	Start blow-down [20] not successful
	90	Cylinder_full	Sensor electrode reports cylinder full status [38] for over 60 min (only for ELDB [77])
	91	Current_measurement	Value provided by current measurement not plausible (only for ELDB [77])
	92	Main_contactor_current	A current is measured for at least 15 s, even though the main contactor [72] is not actuated (only for ELDB [77])
	93	Main_contactor_cyl_full	A cylinder full status [38] was detected for at least 15 s, even though the main contactor [72] is not actuated (only for ELDB [77])
	120	Thermoswitch	A thermo sensor [31] has been triggered (only for HKDB [78])
	120	Thermoswitch	A thermo sensor [31] has been triggered (only for HKDB [78])
	121	Water_level_sensor	Value provided by level control [39] not plausible (only for HKDB [78])
	122	Max.-level	Max. level [40] was reached 5 times in a row during filling (only for HKDB [78])
	123	Steam_down_time	Despite a current feed to the radiators, the water level has not changed in the period specified ->[53] (only for HKDB [78])
	124	Relay_main_contactor	The relay for the control of the main contactor is not functioning correctly

Entries on the unit info screen (ctd.)

No.	Parameter	No.	Adjustment/value range Factory setting (FS) Bold min max FS	Meaning/Comment [] explains the term in the glossary →[] refers to a related explanation of the term
3	Fault_message_cyl. 2		Read value see: 02-2 Fault_message_cyl. 1	List of possible fault messages for cylinder 2 (see Fault_message_unit)
5	Service_message_cyl. 1		Read value	List of service messages for cylinder 1
		0	No_service_msg.	A service is not required
		1	Steam_amount_counter	A unit service is required due to the steam volume counter
		2	Cycles_main_contactor 1	The maximum number of operating cycles for K1 has been reached and a Service_main_contactor [34] is required
		3	Cycles_main_contactor 2	The maximum number of operating cycles for K2 has been reached and a Service_main_contactor [34] is required
		4	Cycles_main_contactor 3	The maximum number of operating cycles for K3 has been reached and a Service_main_contactor [34] is required
		5	Cycles_main_contactor 4	The maximum number of operating cycles for K4 has been reached and a Service_main_contactor [34] is required
		6	Cycles_main_contactor 5	The maximum number of operating cycles for K5 has been reached and a Service_main_contactor [34] is required
		12	Warning_electrodes	The condition of the electrodes will require a replacement shortly (only for ELDB [77]) →[95]
		13	Warning_pump	In the area of the blow-down pump and/or the piping, there are indications that maintenance requirements are starting to develop →[95]
		14	Warning_valve	At a solenoid valve and/or the piping, there are indications that maintenance requirements are starting to develop →[95]
6	Service_message_cyl. 2		Read value see: 02-5 Service_message_cyl. 1	List of service messages for cylinder 2
7	Model		Read value	Type designation of unit
8	Unit_name		Read value	Unit name [90], can be selected by the customer, if required
9	Serial_number		Read value	Serial_number
10	Date_of_manufacturing		Read value	Date_of_manufacturing
11	Software_version		Read value	Software version of control
12	Production_total_time		Read value	Total duration of steam production since initial operation (specified in days/months/years/hours/minutes)
13	Unit_total_runtime		Read value	The total runtime of the unit since its first connection to the power supply (specified in days/months/years/hours/minutes)
16	Steam_amount_total_cyl. 1		Read value	Entire steam volume of cylinder 1 [lbs] produced since initial operation
17	Steam_amount_total_cyl. 2		Read value	Entire steam volume of cylinder 2 [lbs] produced since initial operation (double cylinder units only)

6. Faults and Warnings

6.1 Fault Management

In the event of a fault, the steam production is halted. The relevant display field is then shown instead of the HygroMatik logo. The display field shows a warning symbol, the „Fault“ message and - in paranthesis - the fault code:

e.g.:





When touching the fault message display field, the unit info screen opens with the fault message in plain text and information concerning the unit and its current state.





The majority of fault messages is additionally accompanied by the flashing of one or more icons, allowing for a first limitation of the cause of fault.





6.1.1 Table of Fault Messages, possible Causes and Countermeasures

These icons flash	Fault Code	Fault message	Possible cause	Countermeasure
	001	Plug_(ST09) The plug for the current transducer or the water sensor is not connected.	<ul style="list-style-type: none"> • Plug sits not firmly or is not in place 	<ul style="list-style-type: none"> • Check plug and connect, if required
	002	Cylinder_extension Extension board not detected by the software.	<ul style="list-style-type: none"> • P.c.b. connection not o.k. • P.c.b. not present or defective • CAN bus addressing not correct 	<ul style="list-style-type: none"> • Check firm connection of boards • Connect board, replace board if defective • Check DIP switch settings on extension board (see fig. in section 3.4).
	006 007	Relay_extension 1 Relay_extension 2 Relay board (s) not detected by the software.	<ul style="list-style-type: none"> • P.c.b. connection(s) not o.k. • P.c.b.(s) not present or defective • CAN bus addressing not correct 	<ul style="list-style-type: none"> • Check firm connection of boards • Connect board(s), replace board(s) if defective • Check DIP switch settings on relay boards (see fig. in section 3.5).
	022	Input_current_min	<ul style="list-style-type: none"> • Sensor, wiring or signal source defective • Input stage defective 	<ul style="list-style-type: none"> • Check sensor, wiring and signal source, if relevant • Replace mainboard
	024 025)	Input_resistance_OC Input_resistance_SC The resistance measured is not correct („infinite“ or „zero“, resp.)	<ul style="list-style-type: none"> • Sensor, wiring or signal source defective • Input stage defective 	<ul style="list-style-type: none"> • Check sensor, wiring and signal source, if relevant • Replace mainboard





*) When the PI controller is in use, fault codes 022 to 025 relate to the sensor. In case of an external controller, the signal source is referred to.

These icons flash	Fault Code	Fault message	Possible cause	Countermeasure
	029	Internal	<ul style="list-style-type: none"> • Main board is defective 	<ul style="list-style-type: none"> • Replace mainboard
	030 032	<p>Filling_valve 1 Filling_valve 1 a. 2</p> <p>Filling was not successful, i.e. the expected filling level was not achieved after a device-specific time (15 - 45 min)</p>	<ul style="list-style-type: none"> • Solenoid valve or water supply line contaminated or defective • Solenoid valve defective • Water supply not opened • Solenoid valve electrically not driven <ul style="list-style-type: none"> - electrical cabling not o.k. - Mainboard relay not energised • Steam hose not laid with sufficient incline/decline resulting in a water bag obstructing steam flow. Steam builds up pressure in steam cylinder and pushes water towards drain • Blockage in steam pipe impedes the steam flow. The steam builds up pressure in the cylinder and presses the water into the drain. • L3 phase break-down • Main contactor does not switch L3 phase 	<ul style="list-style-type: none"> • Clean water supply line and/or solenoid valve; replace solenoid valve, if defective • Make measurement on solenoid; replace solenoid valve, if defective • Open water supply - Check electrical cable and replace, if required - Measure voltage on mainboard terminal 11 against N; replace mainboard, if required • Check steam hose layout. Eliminate water bag. • Remove blockage in steam pipe • Reestablish L3 phase feeding • Replace main contactor

These icons flash	Fault Code	Fault message	Possible cause	Countermeasure
	061 062 063 064 065 066 067	<p>Part_blow-down Full_blow-down Blow-down_dilution(only ELDB) Max._current_blow-down (only ELDB) (Max._level_blow-down (only HKDB) Standby_blow-down Start_blow-down (only HKDB)</p> <p>The respective blow-down was not successful.</p>	<ul style="list-style-type: none"> • Blow-down pump is not driven <ul style="list-style-type: none"> - electrical wiring is not o.k. - Mainboard relay is not energised • Blow-down pump defective • Blow-down pump is working but water is not drained (i.e. cylinder drain is blocked) • Blow-down pump blocked by scale deposits • Water sensor defective (only HKDB) 	<ul style="list-style-type: none"> - Check wiring and replace, if required - Measure voltage on mainboard terminal 10 against N; replace mainboard, if required • Replace blow-down pump • Check blow-down pump, drainage system and steam cylinder for hardeners and clean • Check blow-down pump, drain system and cylinder for scale deposits and clean • Replace water sensor
	090	<p>Cylinder_full (only ELDB) The sensor electrode consistently reports cylinder full status for 60 min</p>	<ul style="list-style-type: none"> • Low or widely fluctuating water conductivity • Electrodes worn out • No electrode cable run through current transducer • Salt bridges in steam-cylinder upper part • Foaming (when softened water is used) 	<ul style="list-style-type: none"> • Check feed water quality; consult your expert dealer, if required • Replace electrodes • Run one phase through current transducer • Clean • Increase blending rate (bigger raw water proportion)
 	091	<p>Current_measurement (only ELDB) The current transducer reading is not correct</p>	<ul style="list-style-type: none"> • Plug is not seated properly on mainboard • Current transducer defective 	<ul style="list-style-type: none"> • Check plug seating • Replace current transducer





These icons flash	Fault Code	Fault message	Possible cause	Countermeasure
	092	Main_contactor_current (only ELDB) A current is measured though the main contactor is not driven.	<ul style="list-style-type: none"> • Main contactor contact sticks 	<ul style="list-style-type: none"> • Replace main contactor
	093	Main_contactor_cyl._full (only ELDB) „Cylinder full“ is detected though the main contactor is not driven.	<ul style="list-style-type: none"> • Main contactor contact sticks 	<ul style="list-style-type: none"> • Replace main contactor
	120	Thermoswitch (only HKDB) Minimum one of the thermoswitches has tripped.	<ul style="list-style-type: none"> • Thermoswitch on steam cylinder cover has tripped due to lime coating on heating element • Capillary tube defective • Thermo switch on solid state relay has triggered due to blocked ventilation • Blockage in a connection hose (see no. 21/22 in the exploded view in the main manual) leads to incorrect water level detection, which can cause the thermal switch to trip. 	<ul style="list-style-type: none"> • Switch off power supply. Remove lime coating. Allow cool-down of steam cylinder. Push-back unblocking pin on thermoswitch with needle-nose pliers or a screwdriver • Replace thermoswitch • Switch off unit. Allow cool-down of heat sink. Remove blockage. Ensure unobstructed ventilation. Restart humidifier operation. • Replace the blocked connection hose. Switch the device on again.
 	121	Water_level_sensor (only HKDB) The water sensor reading is not plausible.	<ul style="list-style-type: none"> • Water sensor is defective • Connecting hoses blocked 	<ul style="list-style-type: none"> • Replace water sensor • Clean hoses

These icons flash	Fault Code	Fault message	Possible cause	Countermeasure
	<p>122</p>	<p>Max.-level (only HKDB)</p> <p>Water level has reached its maximum 5x in one single steam production phase.</p>	<ul style="list-style-type: none"> • Excessive air pressure in duct has impact on water in steam cylinder via steam hose. Water is pressed into drainage • Solenoid valve closing action imperfect. Cylinder water level rises though solenoid valve is not energised • Solenoid valve is permanently energised (water intake stops when unit is switched off) • Large amounts of residues influence or restrict cyclic blow-down. The additional water introduction caused by the optional HyFlush rinse device may cause the max. level fault 	<ul style="list-style-type: none"> • Reduce air pressure, check steam hose for blockages • Check solenoid valve • Relay contacts on mainboard stick. Measure voltage across terminal 11 and N; replace mainboard, if required • Clean steam cylinder, cylinder base, water sensor tubing and drainage system

These icons flash	Fault Code	Fault message	Possible cause	Countermeasure
 	123	<p>Steam_down_time (only HKDB) The heaters are supplied with current, but water level doesnot change.</p>	<ul style="list-style-type: none"> • Heater element is defective • Phase failure (external circuit breaker has tripped or is defective) • Heater elements not supplied with voltage • Main contactor swiching not o.k. • Main contactor not driven by mainboard relay 	<ul style="list-style-type: none"> • Measure heater element resistance; replace heater element, if required. Nominal resistance values are: FLH03 - 2.25 kW / 230 V - 21.3 - 26.1 Ω FLH06 – 4.5 kW / 400 V – 32.3 - 39.5 Ω FLH09 – 6.75 kW / 400 V - 21.5 - 26.3 Ω FLH15 – 3.8 kW / 400 V – 38.2 - 46.8 Ω (3x) FLH25 – 6.3 kW / 400 V – 23.1 - 28.2 Ω (3x) FLH30 – 3.8k W / 400 V - 38.2-46.8 Ω (6x) FLH40 – 6.3 kW / 400 V – 23.1 - 28.2 Ω (3x) + 3.8 kW / 400 V – 38.2 - 46.8 Ω (3x) FLH50 – 6.3 kW / 400 V – 23.1 - 28.2 Ω (6x) • Replace external circuit breaker, eliminate cause for tripping • Check wiring and voltage supply • Check main contactor; replace, if required • Measure voltage on mainboard terminal 9 against N; replace mainboard, if required
	124	<p>Relay_main_contactor (only HKDB) The main contactor is not driven by the electronics on the mainboard, but a voltage is measured</p>	<ul style="list-style-type: none"> • Mainboard relay contacts stick 	<ul style="list-style-type: none"> • Replace mainboard
	210 211	<p>Humidity_sensor Humidity_sensor 2 The respective humidity sensor reading is implausible.</p>	<ul style="list-style-type: none"> • Sensor cable defective • Sensor defective 	<ul style="list-style-type: none"> • Check sensor cable • Replace sensor

6.2 Service messages and warnings

Service messages and warnings are shown on the main screen in place of the HygroMatik logo, when the cause has occurred. When tipping the display field, the unit info screen is shown with the messages in plain text.

Mainscreen presentation	Message	Possible cause	Countermeasure
	Steam_amount counter	The maintenance interval has expired.	Service or check steam humidifier. Reset the steam amount counter (also see chapter 5.8.4.1 Monitoring and service messages“).
	Cycles_main_contactor x	The maximum number of operating cycles for the main contactor „X“ has been reached (the device can contain several main contactors. „x“ represents the designation number of the main contactor concerned).	The main contactor should be changed. After replacement, the respective counter must be reset with the parameter „Main_contactor_Kx_Reset“ (x=number of main contactor, 1...5) (also see chapter 5.8.4.1 Monitoring and service messages“).
	Warning_cyl._full (only ELDB)	Electrode wear is very advanced.	Replace Electrodes.
	Warning_pump	A performance capability decrease is detected in the area of the blow-down pump and its hosing.	Check area and clean. If warning persists, replace blow-down pump.
	Warning_valve	A performance capability decrease is detected in the area of the solenoid valve, cylinder base and its hosing.	Check area and clean. If warning persists check cylinder base for lime deposit.

The sensitivity threshold of the last three warning messages is set to the highest level ex-factory. Should the on-site conditions (e.g. the water conductivity) lead to an unwanted frequent occurrence of the messages, the sensitivity can be reduced in the „Service“ submenu (s. section 5.8.4).

6.3 Table of functional disruptions

Problem	Possible cause for faulty situation	Countermeasure
Set humidity level not reached	<ul style="list-style-type: none"> • Output limitation parameter setting impedes full power output • Nominal unit output insufficient • Phase failure • Lengthy steam hose layout crossing cold and drafty rooms may lead to increased condensate formation • Improper steam manifold installation may cause condensate formation within air duct • Control signal not properly selected or software setting mismatch • Water quality requires water concentration for full steam output • Excessive pressure in duct system caused by e.g. water bags or partly blocked steam pipes (max. overpressure is 1200 Pa) 	<ul style="list-style-type: none"> • Check „Steam_output_max.“ parameter setting („Control“ submenu, line 2) • Check unit technical data, airflow and secondary airflow • Check circuit breakers • Change unit installation location allowing for shorter steam hose. Insulate steam hose • Check steam manifold position within total system and installation correctness • Check control signal and „Control_settings“ parameter („Control“ submenu, line 1) • Wait • Eliminate particular cause(s)
Excessive humidity	<ul style="list-style-type: none"> • A steam output limitation setting that is too high may result in poor control performance and even condensate formation in ducts • Control signal not properly selected or software setting mismatch 	<ul style="list-style-type: none"> • Check „Steam_output_max.“ parameter setting („Control“ submenu, line 2) • Check control signal and „Control_settings“ parameter („Control“ submenu, line 1)

Problem	Possible cause for faulty situation	Countermeasure
Water collects on bottom plate	<ul style="list-style-type: none"> • Cylinder improperly reassembled following maintenance: <ul style="list-style-type: none"> - O-ring not replaced, defective or not in place - Flange (tongue and groove) damaged - Flange improperly composed - Mineral deposits in flange area • Cylinder improperly inserted in cylinder base • Water cannot drain freely when pumped from cylinder 	<ul style="list-style-type: none"> • Clean cylinder and assemble / install properly • Using moistened new O-ring, insert steam cylinder properly into cylinder base • Make sure drain is unobstructed
Water leaks from steam cylinder upper part	<ul style="list-style-type: none"> • Hose clamps on steam and/or condensate hose not tightened • Steam hose adapter not properly fit or O-ring not replaced 	<ul style="list-style-type: none"> • Tighten clamps • Replace O-ring (if required) and ensure proper adapter installation
No steam production despite the steam humidifier being switched on. Display not illuminated	<ul style="list-style-type: none"> • Defective F1 and/or F2 fuses on main-board • External control voltage failure (ext. circuit breaker has tripped or is defective) • device load circuit breaker has tripped (only ELDB) 	<ul style="list-style-type: none"> • Check micro fuses and replace, if required • Replace breaker and investigate possible causes • Switch on breaker. If problem persists, check for reason
No steam production despite the steam generator being switched on and an illuminated display	<ul style="list-style-type: none"> • The interlock (safety) system is open • The humidity set value has been reached. The control receives no demand for steam production. • A fault has occurred 	<ul style="list-style-type: none"> • Close interlock (safety) system • Check humidity set value and plausibility of actual humidity value • Check unit status
No steam production. Voltage across electrodes exist, but no water is fed into the cylinder (only ELDB)	<ul style="list-style-type: none"> • Water supply not opened or solenoid valve electrically not driven 	<ul style="list-style-type: none"> • Open water supply (s. also Filling fault messages 030 and 032)

Problem	Possible cause for faulty situation	Countermeasure
Blow-down pump works but no water is drained	<ul style="list-style-type: none"> • Steam cylinder and/or drainage system blocked 	<ul style="list-style-type: none"> • Clean cylinder base and/or drainage system, respectively
Cylinder is fully drained after partial blow-down despite pump being switched off	<ul style="list-style-type: none"> • Vent pipe is blocked 	<ul style="list-style-type: none"> • Clean venting bore; replace vent pipe, if required
No steam exit from steam manifold	<ul style="list-style-type: none"> • Steam pipe improperly laid (water bag) or blockage 	<ul style="list-style-type: none"> • Rerun steam hose according to guide lines • Remove blockage
Water exits periodically from drain hose without pump switched on	<ul style="list-style-type: none"> • Excess pressure in duct system (max. overpressure is 1200 Pa) 	<ul style="list-style-type: none"> • Lengthen drain hose system; consult your expert dealer if problem persists
Uneven electrode wear (ELDB only)	<ul style="list-style-type: none"> • One or more electrodes not supplied with power • Circuit breaker tripped • Main contactor contact not functional • Phase loading not symmetric • Electrode immersion depth differs. Unit not mounted plumb 	<ul style="list-style-type: none"> • Check power supply and electrode wiring • Check circuit breaker. Replace, if required • Check main contactor. Replace, if required • Ensure power supply phase balance by measurement • Check installation and correct positioning, if required

Problem	Possible cause for faulty situation	Countermeasure
Flashover/sparks in cylinder(only ELDB)	<ul style="list-style-type: none"> • Very high water conductivity resulting in massive electrode burn-off as indicated by brown-black deposits • Blow-down pump not working properly or defective 	<ul style="list-style-type: none"> • Deactivate unit immediately to prevent material damage Perform maintenance: <ul style="list-style-type: none"> - replace electrodes with high conductivity type - clean steam cylinder - check water quality and conductivity (also s. „Intended use“ section) - optimise blow-down parameters Consult your expert dealer, if required • Check blow-down pump functioning and replace pump, if required. See also fault messages 061 to 067 related to blow-down

7. Wiring Diagrams

7.1 FLE Single cylinder units

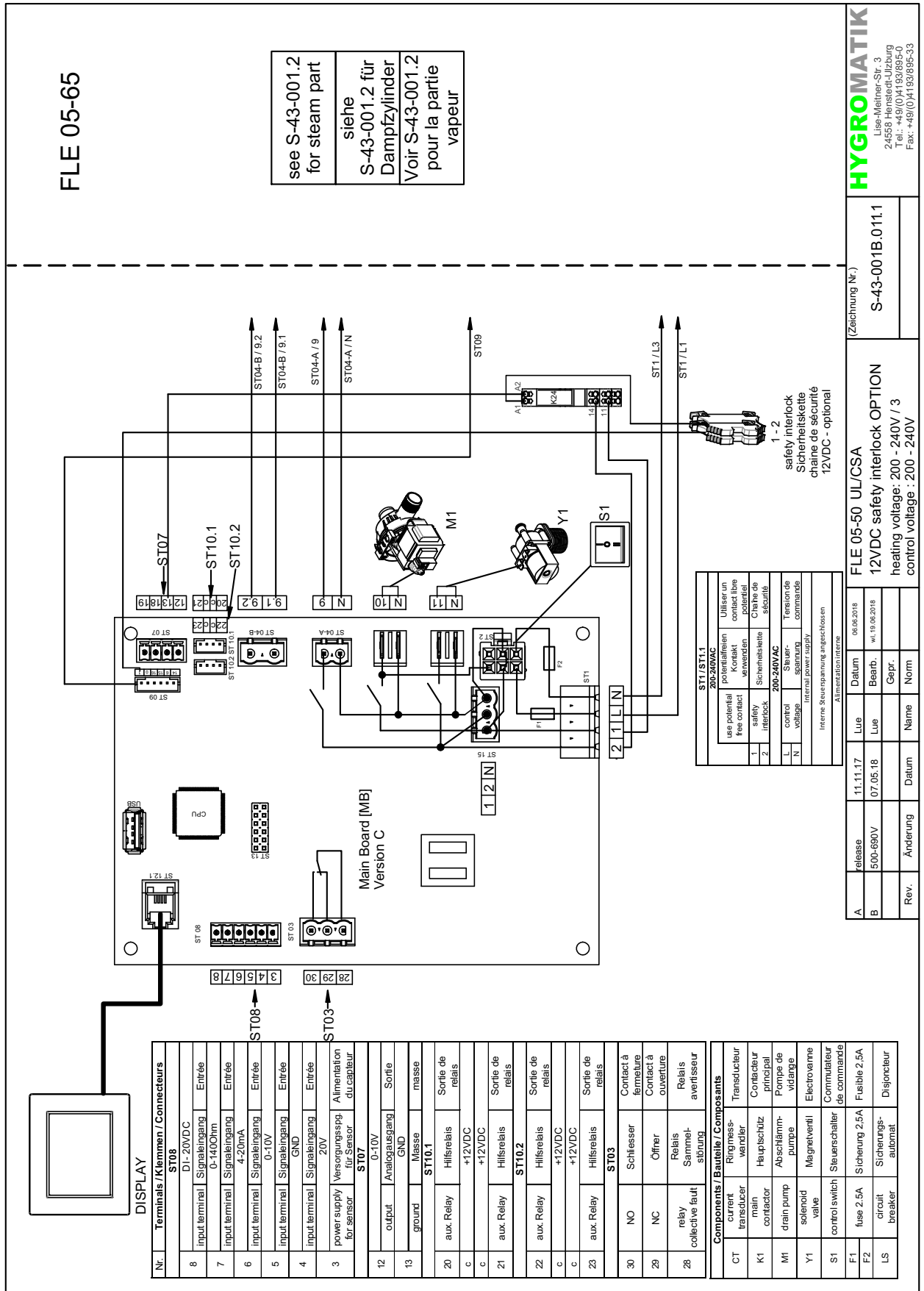

HYGROMATIK
 Lisa-Meiner-Str. 3
 24558 Hüttenberg
 Tel.: +49 (0)4193/895-0
 Fax: +49 (0)4193/895-33

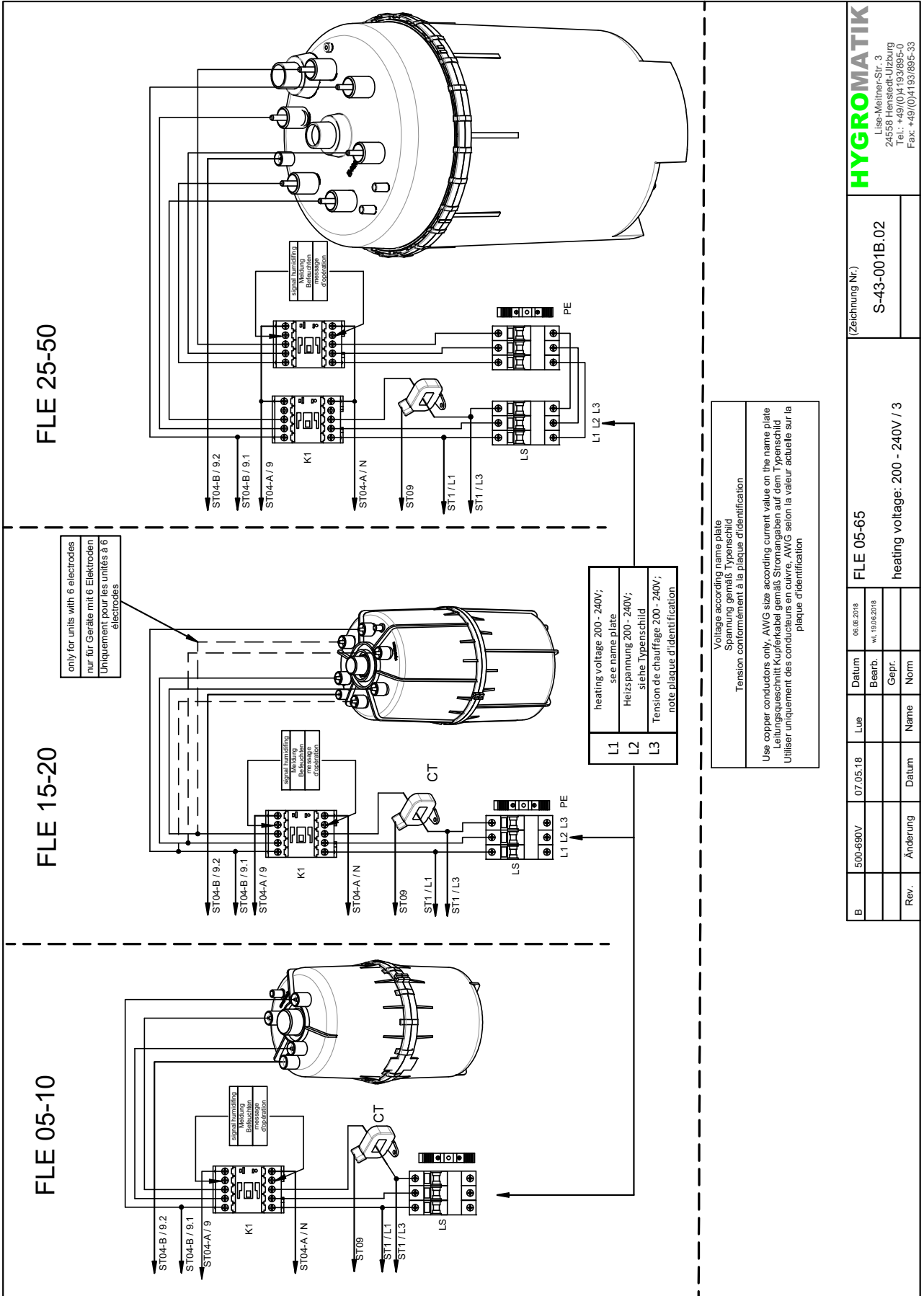

HYGROMATIK
Lise-Meiner-Str. 3
24558 Henstedt-Utzburg
Tel: +49(0)4193/895-0
Fax: +49(0)4193/895-33

(Zeichnung Nr.)
S-43-001B.02

FLE 05-65
heating voltage: 200 - 240V / 3

B	500-690V	07.05.18	Lise	Datum	06.06.2018
			Bearb.	Datum	06.06.2018
			Gepr.	Name	
Rev.	Änderung	Datum	Name	Norm	

see S-43-001.4
 for steam part
 siehe
 S-43-001.4 für
 Dampfzylinder
 Voir S-43-001.4
 pour la partie
 vapeur

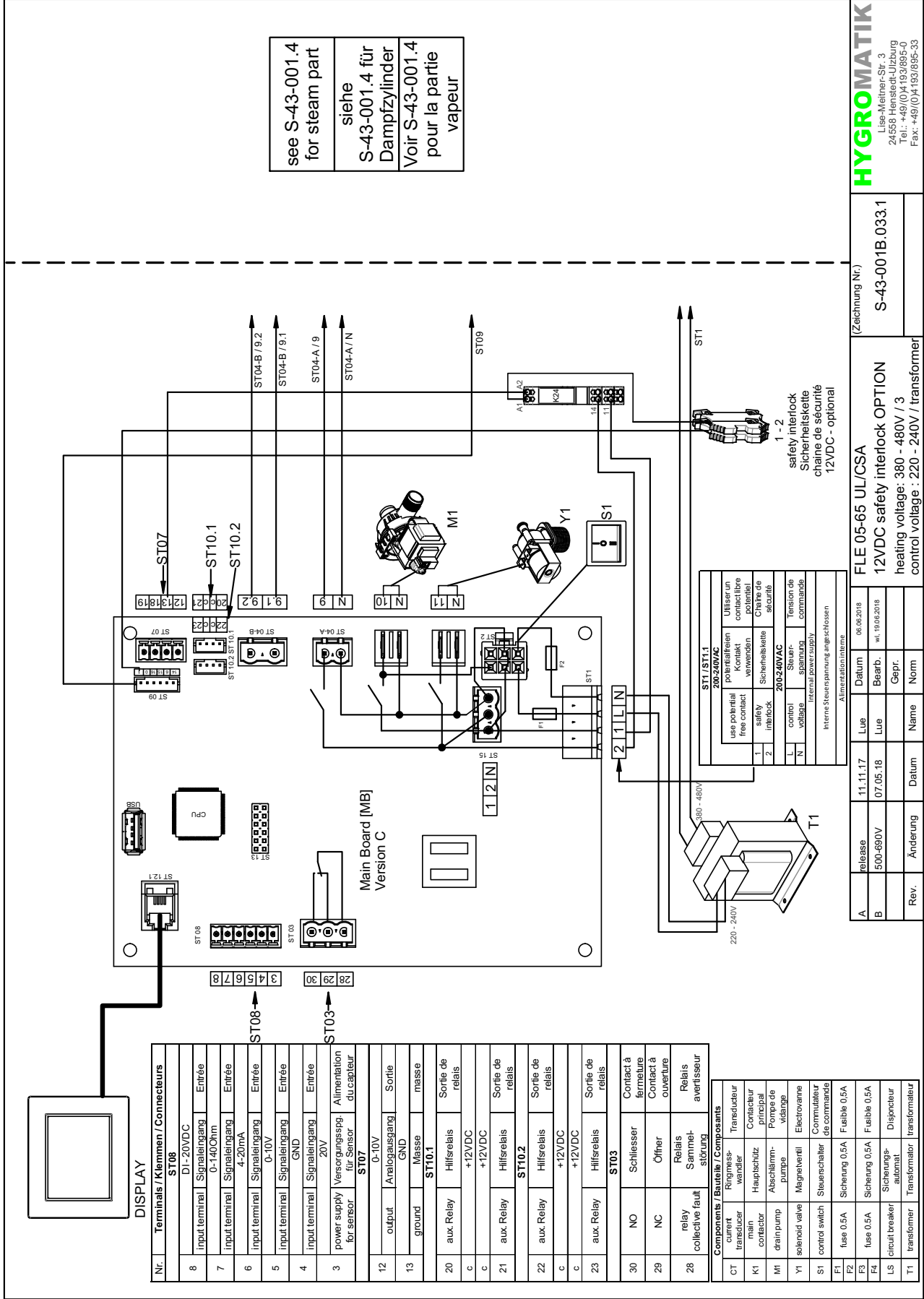

ST1 / ST1.1	
use potential free contact	Utiliser un contact libre potentiel
1 safety interlock	1 Sûreté
2 interlock	2 Sécurité
L control voltage	L Tension de commande
N internal power supply	N Alimentation interne

1 - 2
 safety interlock
 Sûreté
 chaîne de sécurité
 12VDC - optional

DISPLAY	
Terminals / Klemmen / Connecteurs	
ST08	
8	DI-20VDC
8	Input terminal Signalengang Entrée
7	0-140Ohm
7	Input terminal Signalengang Entrée
6	4-20mA
6	Input terminal Signalengang Entrée
5	0-10V
5	Input terminal Signalengang Entrée
4	GND
4	Input terminal Signalengang Entrée
3	20V
3	power supply Alimentation pour le capteur
ST07	
12	0-10V
12	output Analogausgang Sortie
13	GND
13	ground Masse
ST10.1	
20	aux Relay Hilfsrelais
c	+12VDC
c	+12VDC
21	aux Relay Hilfsrelais
c	+12VDC
22	aux Relay Hilfsrelais
c	+12VDC
23	aux Relay Hilfsrelais
c	+12VDC
ST03	
30	NO Schliesser Contact à fermeture
29	NC Öffner Contact à ouverture
28	relay collective fault störung Relais avertisseur

Components / Bauteile / Composants	
CT	current transducer Ringmesswandler
K1	main contactor Hauptschütz
M1	drain pump Abschlämpumpe
Y1	solenoid valve Magnventil
S1	control switch Steuerschalter de commande
F1	fuse 0.5A Sicherung 0,5A
F2	fuse 0.5A Sicherung 0,5A
F3	fuse 0.5A Sicherung 0,5A
LS	circuit breaker Sicherungsautomat
T1	transformer Transformateur

FLE 05-65 UL/CSA				
A	release 11.11.17	Lue	Datum	06.06.2018
B	500-690V	Lue	Bearb.	wl.19.05.2018
Rev.	Änderung	Datum	Name	Gepr.
(Zeichnung Nr.)		S-43-001B.033.1		
12VDC safety interlock OPTION		heating voltage: 380 - 480V / 3		
control voltage: 220 - 240V / transformer				

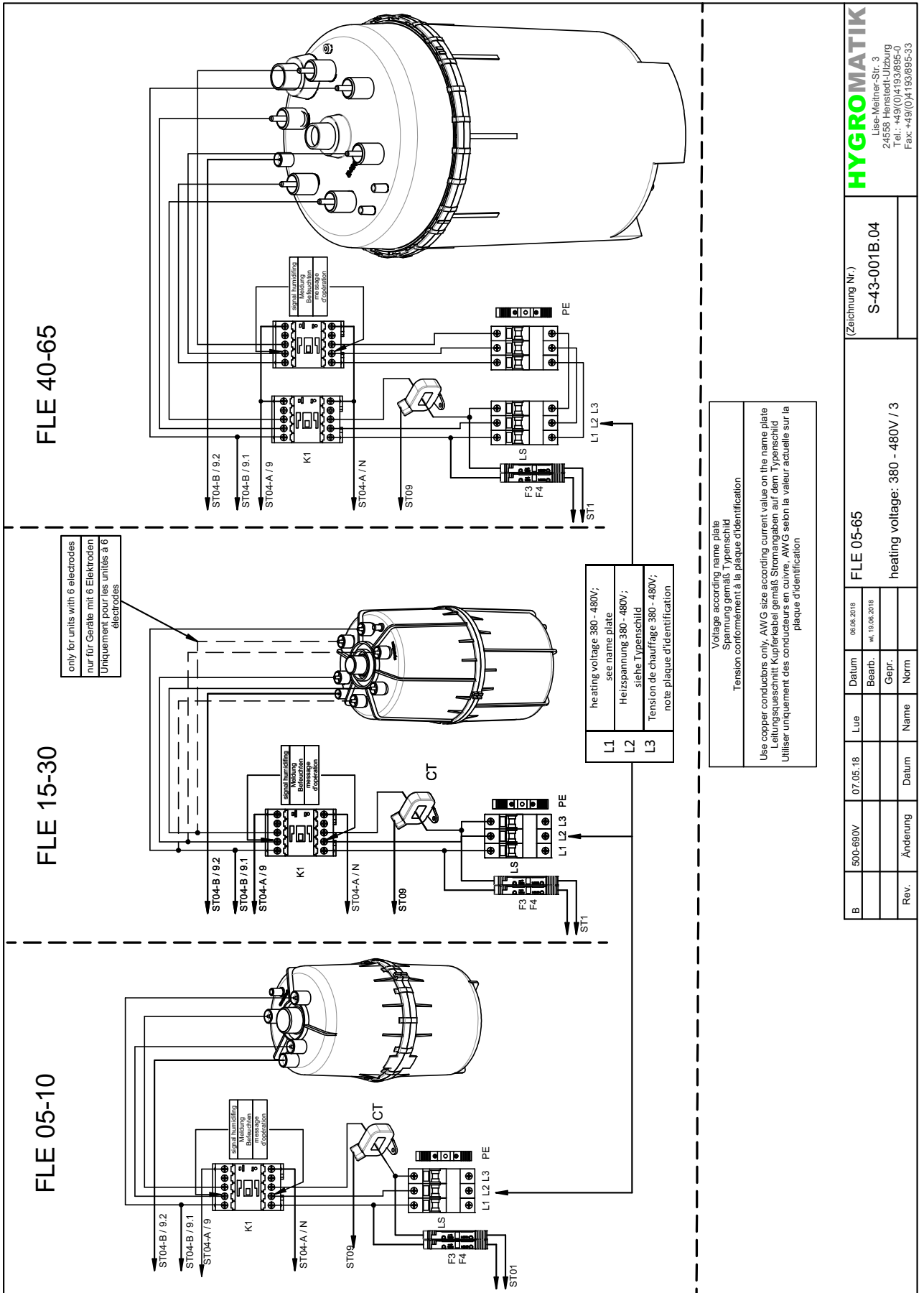

HYGROMATIK
 Lise-Meiner-Str. 3
 24558 Henstedt-Ulzburg
 Tel.: +49(0)4193/895-0
 Fax: +49(0)4193/895-33

(Zeichnung Nr.)
S-43-001B.04

FLE 05-65
 heating voltage: 380 - 480V / 3

Rev.	Änderung	Datum	Name	Norm.
B	500-690V	07.05.18		
		06.06.2018		
		19.06.2018		

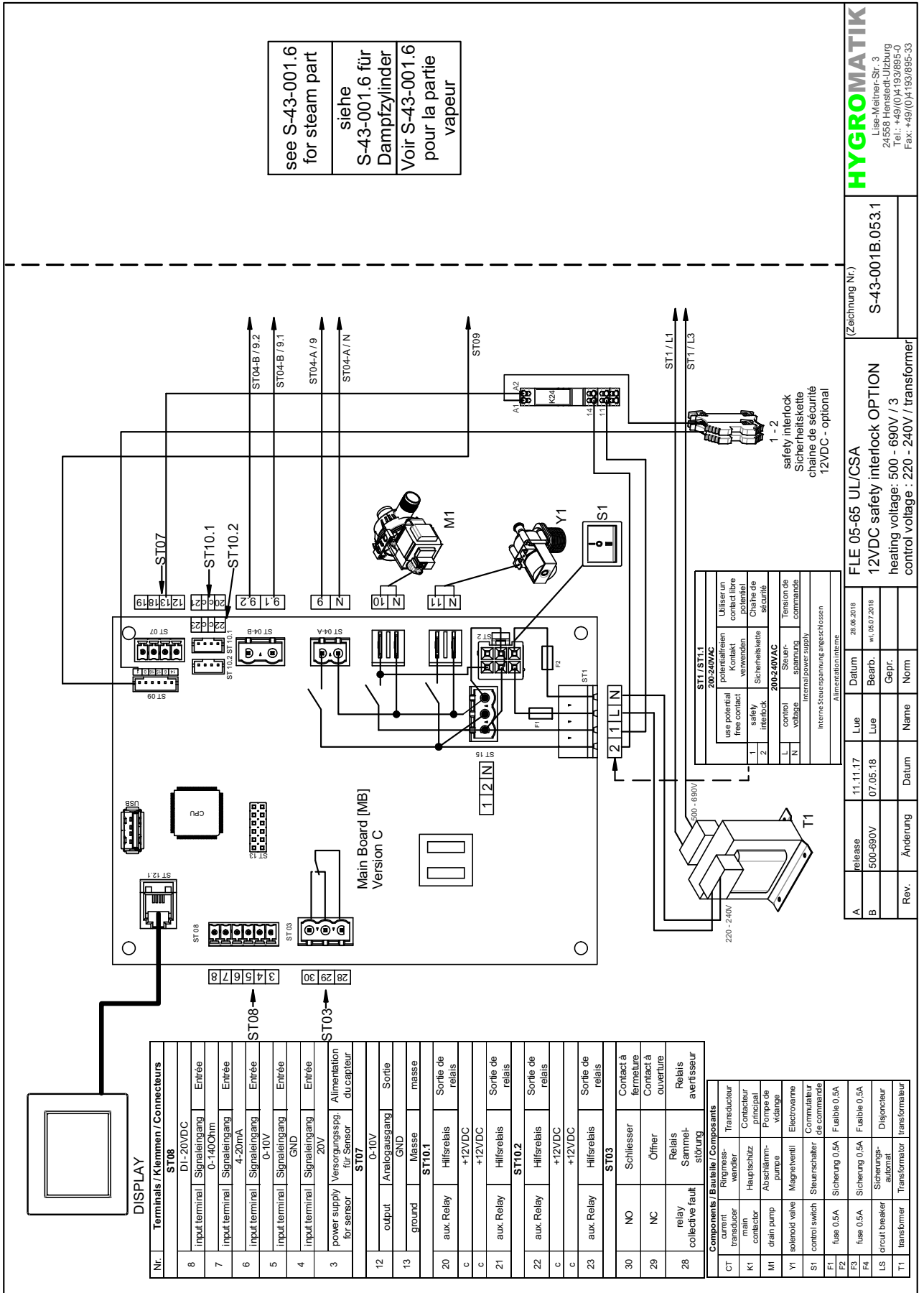

see S-43-001.6
for steam part
siehe
S-43-001.6 für
Dampfzylinder
Voir S-43-001.6
pour la partie
vapeur

HYGROMATIK
Lise-Meiner-Str. 3
24558 Henstedt-Ulzburg
Tel.: +49 (0)4193/895-0
Fax: +49 (0)4193/895-33

(Zeichnung Nr.)
S-43-001B.053.1

FLE 05-65 UL/CSA
12VDC safety interlock OPTION
heating voltage: 500 - 690V / 3
control voltage: 220 - 240V / transformer

use potential free contact	Utiliser un potentiel libre contact
1 safety interlock	1 Châsse de potentiel sécurité
2	2 Sécurité
L control voltage	L Tension de commande
N	N
Interne Steuerspannung ange-schlossen Alimentation interne	

A	release	11.11.17	Lue	Datum	28.06.2018
B	500-690V	07.05.18	Lue	Bearb.	wi.05/2018
				Gepr.	
Rev.	Änderung	Datum	Name	Norm	

Terminals / Klemmen / Connecteurs	
ST08	
8	DI - 20VDC Signal Eingang Entrée
7	Input terminal 0-140Ohm Signal Eingang Entrée
6	Input terminal 4-20mA Signal Eingang Entrée
5	Input terminal 0-10V Signal Eingang Entrée
4	Input terminal GND Signal Eingang Entrée
3	Input terminal 20V Signal Eingang Entrée
power supply for sensor Alimentation du capteur	
ST07	
12	output 0-10V Analogausgang Sortie
13	GND masse
ST10.1	
20	aux. Relay Hilfsrelais Sortie de relais
c	+12VDC
c	+12VDC
ST10.2	
21	aux. Relay Hilfsrelais Sortie de relais
22	aux. Relay Hilfsrelais Sortie de relais
c	+12VDC
c	+12VDC
ST03	
23	aux. Relay Hilfsrelais Sortie de relais
30	NO Schlesser Contact à fermeture
29	NC Öffner Contact à ouverture
28	relay collective fault Relais Sammel- störung avertisseur

Components / Bauteile / Composants	
CT	transducer wandler
K1	main contactor Haupt- schütz
M1	drain pump Abschlamm- pumpe
Y1	solenoid valve Magnetventil
S1	control switch Steuerschalter
F1	fuse 0.5A Sicherung 0,5A
F2	fuse 0.5A Sicherung 0,5A
F3	fuse 0.5A Sicherung 0,5A
F4	fuse 0.5A Sicherung 0,5A
LS	crowt breaker Sicherungs- automat
T1	transformer Transformator

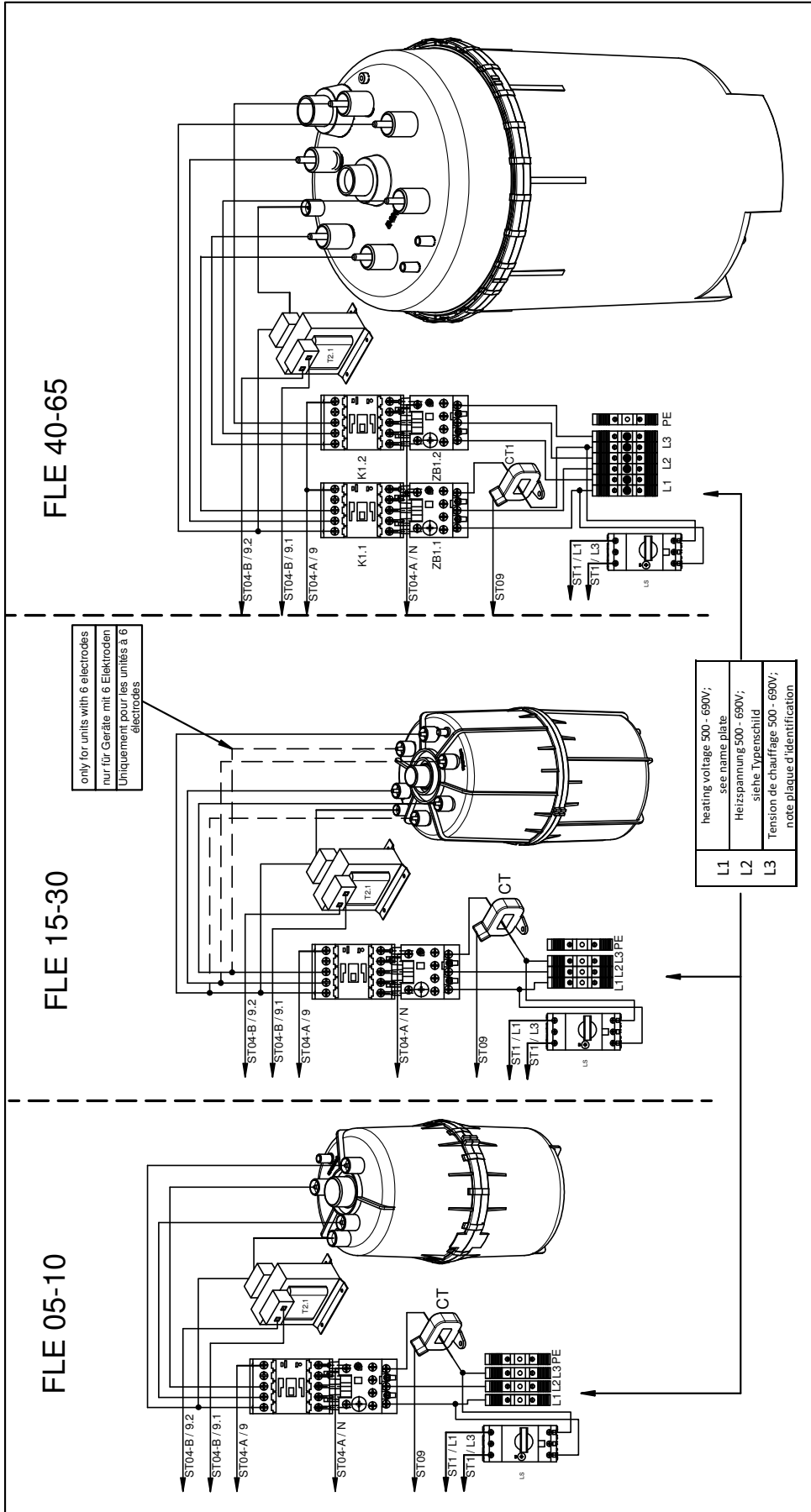

Voltage according name plate
Spannung gemäß Typenschild
Tension conformément à la plaque d'identification

Use copper conductors only, AWG size according current value on the name plate
Leitungsquerschnitt Kupferkabel gemäß Stromangaben auf dem Typenschild
Utiliser uniquement des conducteurs en cuivre, AWG selon la valeur actuelle sur la plaque d'identification

HYGROMATIK		Lise-Melner-Str. 3 24558 Hainstedt-Ulzburg Tel.: +49(0)41933685-33 Fax: +49(0)41933685-33	
S-43-001B.06		(Zeichnung Nr.)	
FLE 05-65		heating voltage: 500 - 690V / 3	
B	500-690V	07.05.18	07.11.2017
Rev.	Änderung	Datum	Name

7.2 FLE Double cylinder units

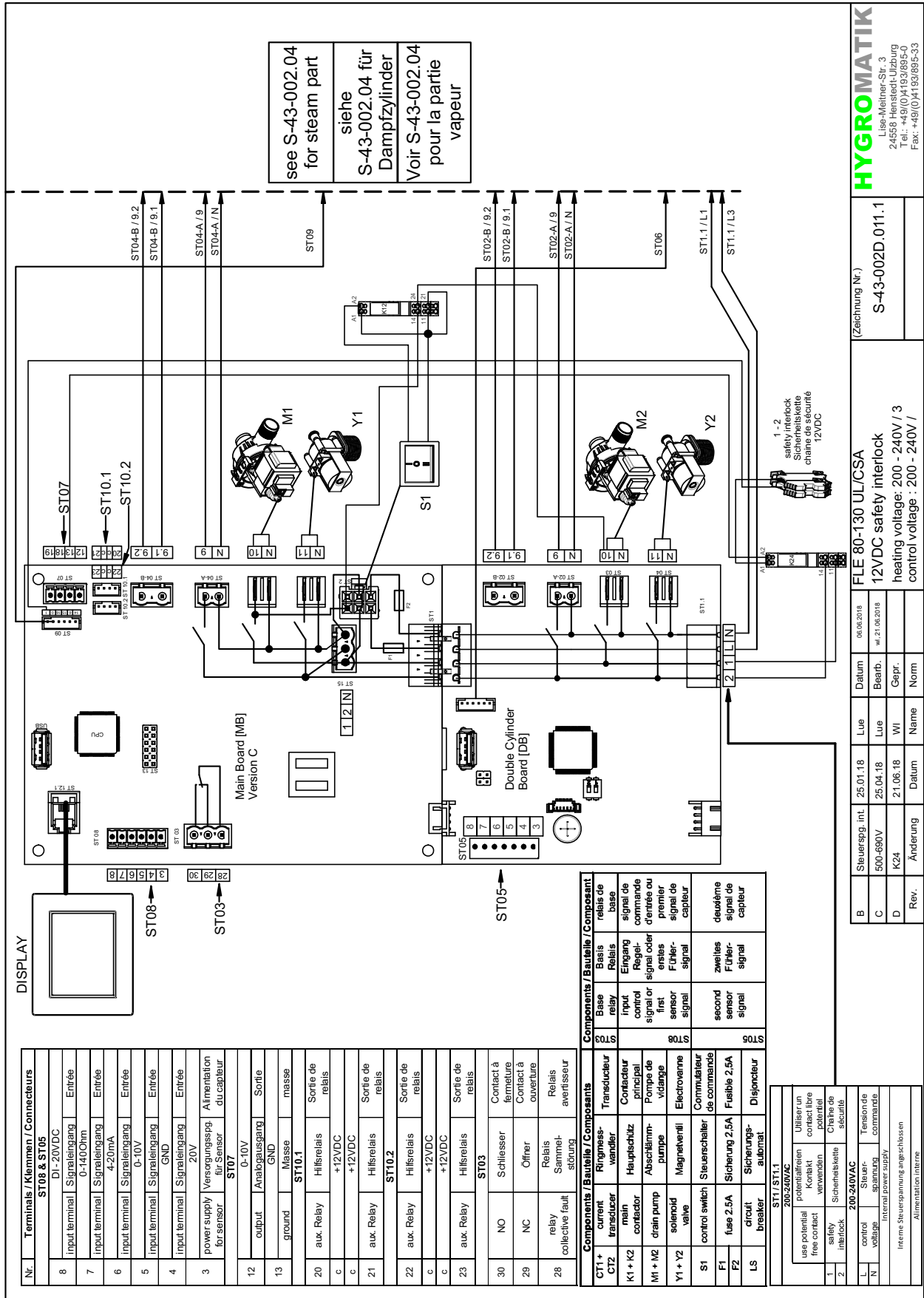

Terminals / Klemmen / Connecteurs	
ST08 & ST05	
8	DI-20VDC
7	input terminal Signalleingang Entrée
6	input terminal Signalleingang Entrée
5	input terminal Signalleingang Entrée
4	input terminal Signalleingang Entrée
3	power supply for sensor Alimentation au capteur
ST07	
12	output Analogausgang Sortie
13	ground Masse
ST10.1	
20	aux. Relay Hilfsrelais
c	+12VDC
21	aux. Relay Hilfsrelais
c	+12VDC
22	aux. Relay Hilfsrelais
c	+12VDC
23	aux. Relay Hilfsrelais
c	+12VDC
ST03	
30	NO Schliesser
29	NC Öffner
28	relay collective fault Relais Sammel-avertisseur störung

Components / Bauteile / Composants	
CT1 + CT2	Transducateur Ringwandler
K1 + K2	Contacteur principal Hauptschütz
M1 + M2	Pompe de vidange Abschlämp-pumpe
Y1 + Y2	Electrovanne Magnetventil
S1	Commutateur de commandes Steuerschalter
F1	Fusible 2,5A Sicherung 2,5A
F2	Fusible 2,5A Sicherung 2,5A
LS	Disjoncteur Sicherungs-automat

Components / Bauteile / Composants	
Base	relais de base
Input relay	signal de commande
Control signal or first sensor signal	entrée ou premier signal de capteur
second sensor signal	deuxième signal de capteur

ST1 / ST1.1	
1	Utiliser un contact libre potentiel
2	Chaine de sécurité
200-240VAC	
1	Utiliser un contact libre potentiel
2	Chaine de sécurité
200-240VAC	
1	Tension de commande
2	Alimentation interne

HYGROMATIK
 Lise-Meiner-Str. 3
 24558 Henstedt-Ulzburg
 Tel.: +49(0)4193/895-0
 Fax: +49(0)4193/895-33

(Zeichnung Nr.)
S-43-002D.011.1

FLE 80-130 UL/CSA
 12VDC safety interlock
 heating voltage: 200 - 240V / 3
 control voltage: 200 - 240V /

Rev.	Änderung	Name	Datum	Lue	Datum
B	Steuerung, int.	25.01.18	Lue	06.06.2018	
C	500-690V	25.04.18	Lue	21.06.2018	
D	K24	21.08.18	WI	Gepr.	
				Norm	

Rev.	Änderung	Name	Datum	Lue	Datum
B	Steuerung, int.	25.01.18	Lue	06.06.2018	
C	500-690V	25.04.18	Lue	21.06.2018	
D	K24	21.08.18	WI	Gepr.	
				Norm	

FLE 80-130

Left cylinder
Linker Zylinder
Cylindre gauche

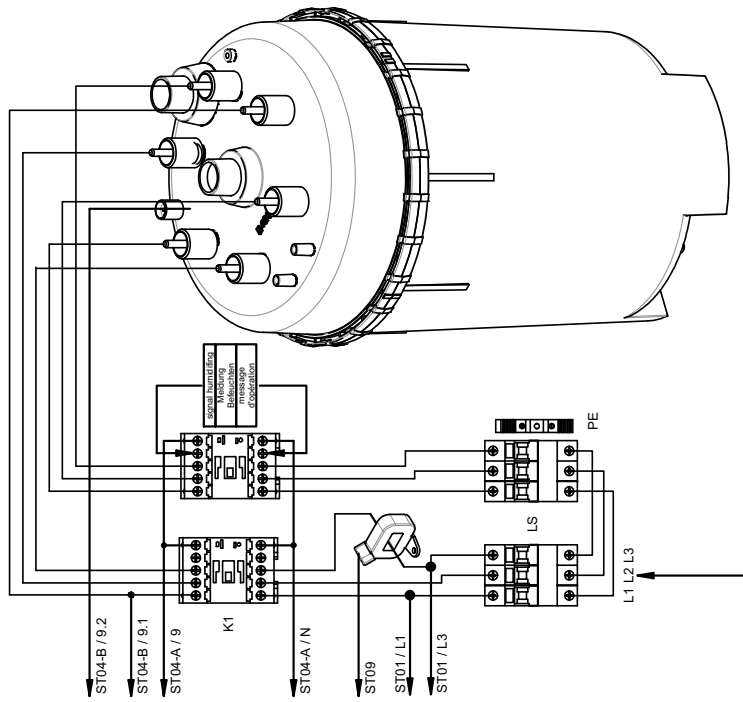

Right cylinder
Rechter Zylinder
Cylindre droit

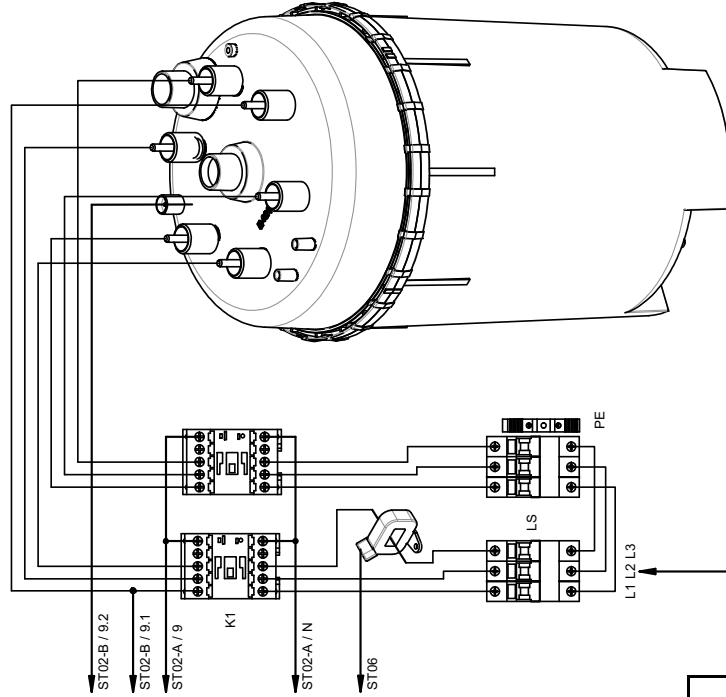

L1	heating voltage 200 - 240V; see name plate
L2	Heizspannung 200 - 240V; siehe Typenschild
L3	Tension de chauffage 200 - 240V; note plaque d'identification

Voltage according name plate
Spannung gemäß Typenschild
Tension conformément à la plaque d'identification

Use copper conductors only, AWG size according current value on the name plate
Leitungsquerschnitt Kupferkabel gemäß Stromangaben auf dem Typenschild
Utiliser uniquement des conducteurs en cuivre, AWG selon la valeur actuelle sur la plaque d'identification

Rev.	Änderung	Datum	Name	Norm
A	release	11.11.17	Lue	
B	Steuerspg. Int.	25.01.18	Lue	
			Gepr.	

heating voltage: 200 - 240V / 3

(Zeichnung Nr.)
S-43-002B.06

HYGROMATIK
Lise-Meiner-Str. 3
24458 Hersted-Utzburg
Tel.: +49 (0)4193/895-0
Fax: +49 (0)4193/895-33

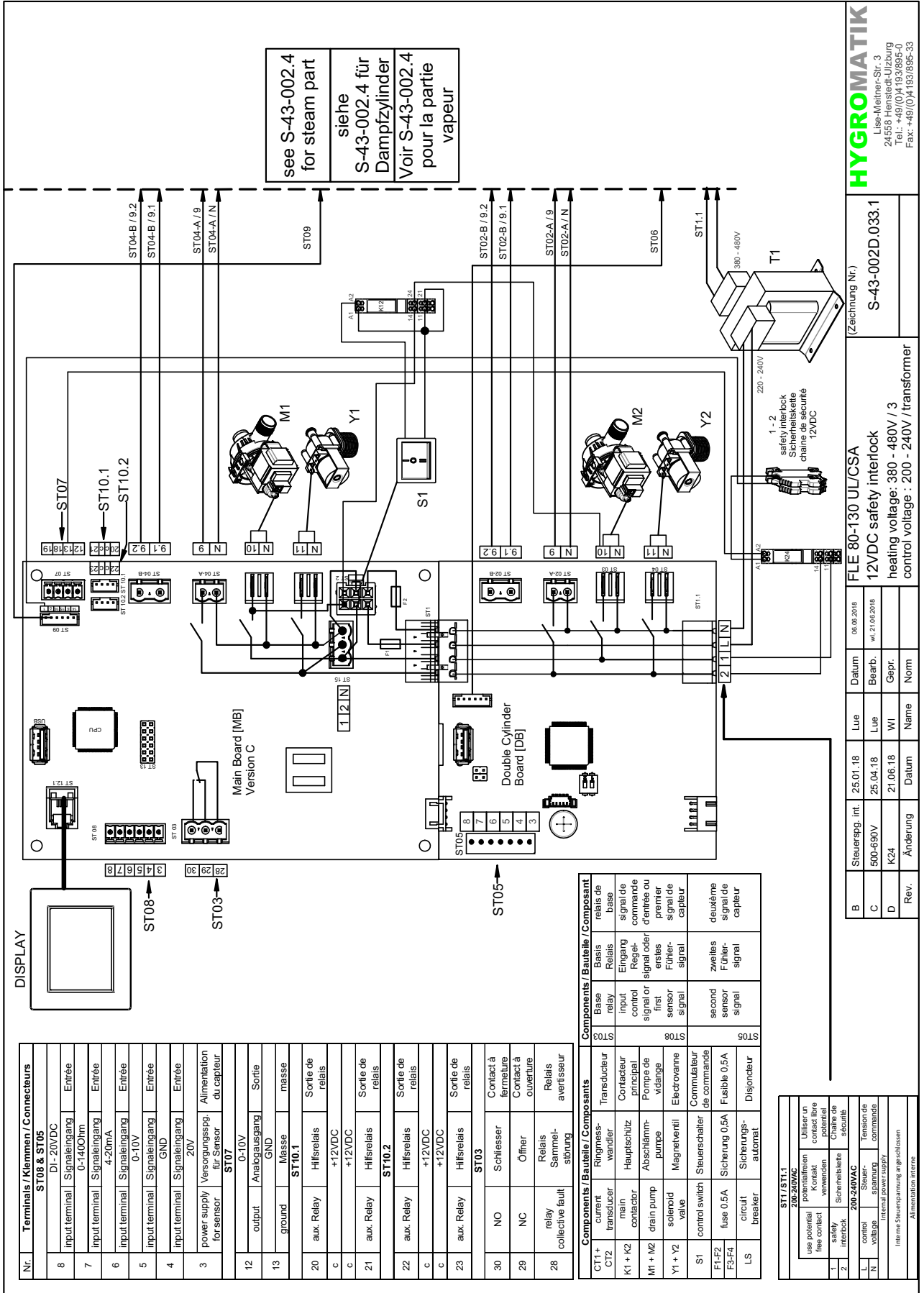

see S-43-002.4
for steam part

siehe
S-43-002.4 für
Dampfzylinder

Voir S-43-002.4
pour la partie
vapeur

Terminals / Klemmen / Connecteurs	
ST08 & ST05	
8	DI- 20VDC input terminal Signaleingang Entrée
7	0-1400hm input terminal Signaleingang Entrée
6	4-20mA input terminal Signaleingang Entrée
5	0-10V input terminal Signaleingang Entrée
4	GND input terminal Signaleingang Entrée
3	20V power supply Versorgungsppg. Alimentation for sensor for Sensor du capteur
ST07	
12	0-10V output Analogausgang Sortie
13	GND ground Masse
ST10.1	
20	aux. Relay Hilfsrelais
c	+12VDC
21	aux. Relay Hilfsrelais
c	+12VDC
ST10.2	
22	aux. Relay Hilfsrelais
c	+12VDC
23	aux. Relay Hilfsrelais
c	+12VDC
ST03	
30	NO Schliesser Contact à fermeture
29	NC Öffner Contact à ouverture
28	relay Relais
	collective fault Sammelstörung

Components / Bauteile / Composants	
CT1 + CT2	current transducer Ringmesswandler
K1 + K2	main contactor Hauptschutz
M1 + M2	drain pump Abschlämp-pumpe
Y1 + Y2	solenoid valve Magnetventil
S1	control switch Steuerschalter
F1-F2	fuse 0.5A Sicherung 0.5A
E3-F4	LS
LS	circuit breaker Sicherungsautomat

ST1 / ST1.1	
200-240VAC	power potential use potential freie potential verwendung
1	interlock
2	safety interlock
200-240VAC	control voltage interlock
1	control voltage interlock
2	control voltage interlock

HYGROMATIK
Lise-Melner-Str. 3
24558 Henstedt-Ulzburg
Tel.: +49 (0)4193/895-0
Fax: +49 (0)4193/895-33

(Zeichnung Nr.)
S-43-002.D.033.1

FLE 80-130 UL/CSA
12VDC safety interlock
heating voltage: 380 - 480V / 3
control voltage: 200 - 240V / transformer

Rev.	Änderung	Datum	Name	Gepr.	Norm
B	Steuerspg. int.	25.01.18	Lue	06.08.2018	
C	500-690V	25.04.18	Lue	wh.21.06.2018	
D	K24	21.06.18	WL		

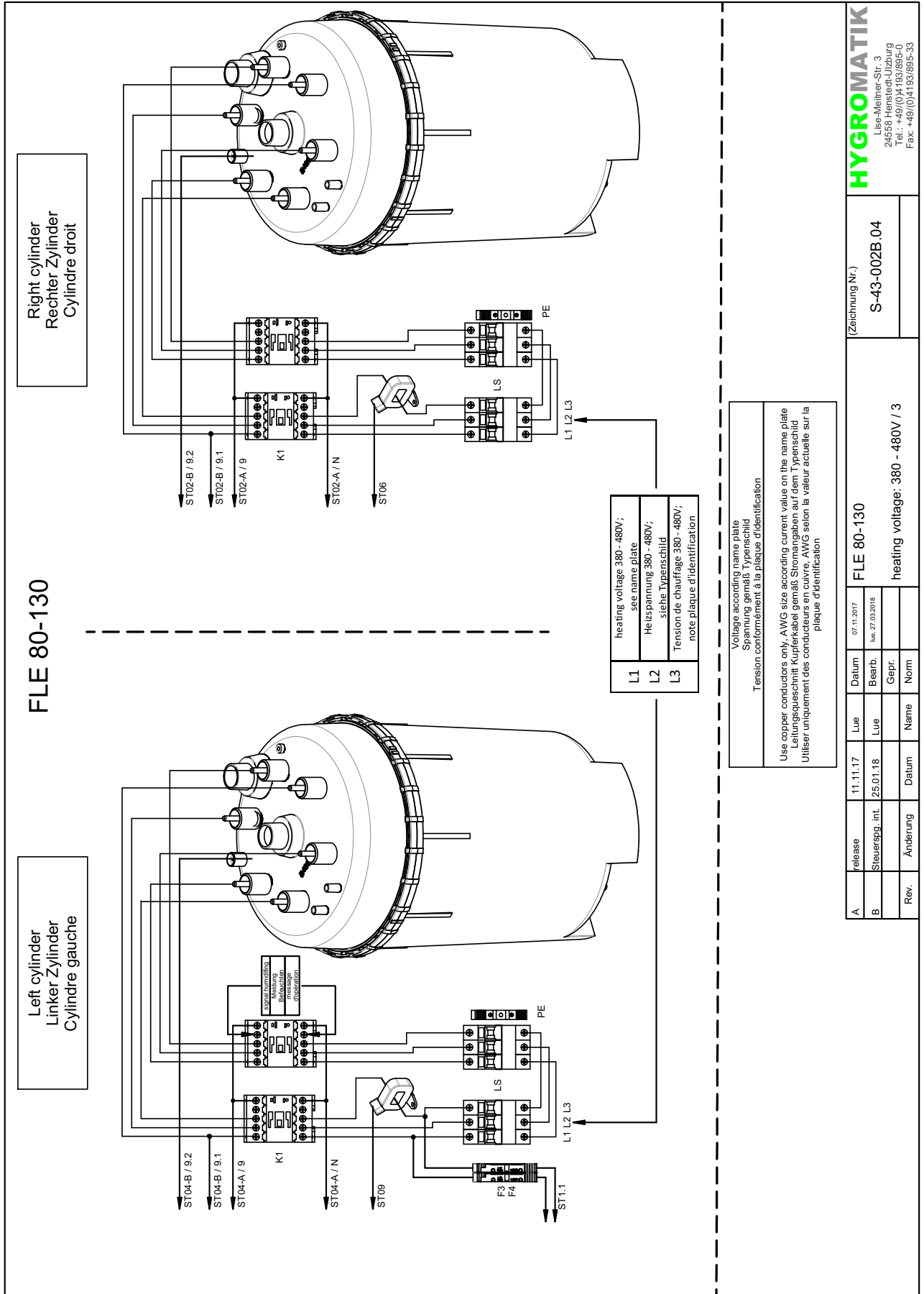

HYGROMATIK
Lise-Melmer-Str. 3
24558 Hensted-Lübzburg
Tel.: +49 (0) 41 93 695-0
Fax: +49 (0) 41 93 695-33

(Zeichnung Nr.)
S-43-002B.04

FLE 80-130
heating voltage: 380 - 480V / 3

A	release	11.11.17	Lue	Datum	07.11.2017	FLE 80-130
B	Steuersg. int.	25.01.18	Lue	Bearb.	16.07.2018	S-43-002B.04
Rev.	Änderung	Datum	Name	Gepr.	Norm	

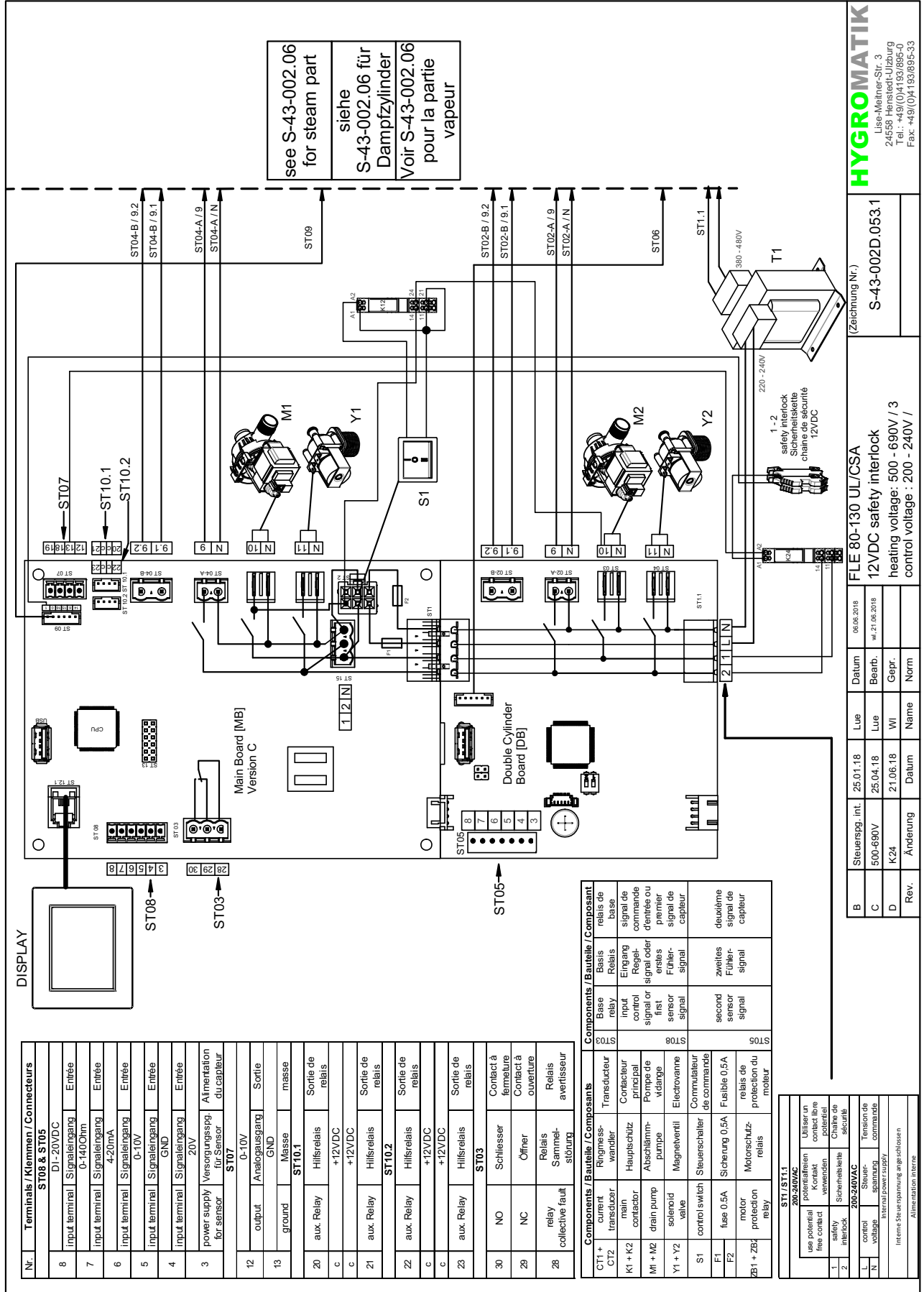

see S-43-002.06
for steam part
siehe
S-43-002.06 für
Dampfzylinder
Voir S-43-002.06
pour la partie
vapeur

Terminale / Klemmen / Connecteurs	
ST08 & ST05	
8	DI-20VDC input terminal Signaleingang Entrée
7	0-1400Ohm input terminal Signaleingang Entrée
6	4-20mA input terminal Signaleingang Entrée
5	0-10V input terminal Signaleingang Entrée
4	GND input terminal Signaleingang Entrée
3	20V power supply Versorgungspg Alimentation for sensor für Sensor du capteur
ST07	
12	0-10V output Analogausgang Sortie
13	GND ground Masse masse
ST10.1	
20	aux. Relay Hilfrelais
c	+12VDC Sortie de relais
ST10.2	
21	aux. Relay Hilfrelais
c	+12VDC Sortie de relais
ST03	
30	NO Schliesser
29	NC Öffner
28	Relais Sammel- störung Relais avertisseur

Composants / Bauteile / Composants			
CT1 +	current Ringmess- wandler	Transducteur	Basis relais de
CT2	main contactor	Contacteur principal	signal de commande base
K1 + K2	Hauptschutz		Regel- signal oder entrée ou premier signal de entrée ou premier Fühler- signal
M1 + M2	drain pump	Pompe de vidange	signal de entrée ou premier Fühler- signal
Y1 + Y2	solenoid valve	Magnetventil	signal de entrée ou premier Fühler- signal
S1	control switch	Commutateur de commande	second Fühler- signal
F1	fuse 0.5A	Fusible 0.5A	deuxième signal de capteur
F2	motor protection relay	relais de protection du moteur	
ZB1 + ZB2			

ST1 / ST1.1		
1	use potential contact free contact	Utiliser un potentiel contact libre sans charge
2	safety interlock	Sicherheitskette Sicherheitskette
L	control voltage	Tension de commande
N	motor protection relay	relais de protection du moteur
interne Steuerspg. / interne Steuerspannung / angriffslose / interne Steuerspannung / angriffslose		
Alimentation interne		

HYGROMATIK
Lise-Meiner-Str. 3
24558 Henstedt-Ulzburg
Tel.: +49(0)4193/895-0
Fax: +49(0)4193/895-33

(Zeichnung Nr.)
S-43-002D.053.1

FLE 80-130 UL/CSA
12VDC safety interlock
heating voltage: 500 - 690V / 3
control voltage : 200 - 240V /

Rev.	Änderung	Datum	Name	Norm
B	Steuerspg. int.	25.01.18	Lue	06.06.2018
C	500-690V	25.04.18	Lue	w.21.06.2018
D	K24	21.06.18	Wi	Gepr.

FLE 80-130

Left cylinder
Linker Zylinder
Cylindre gauche

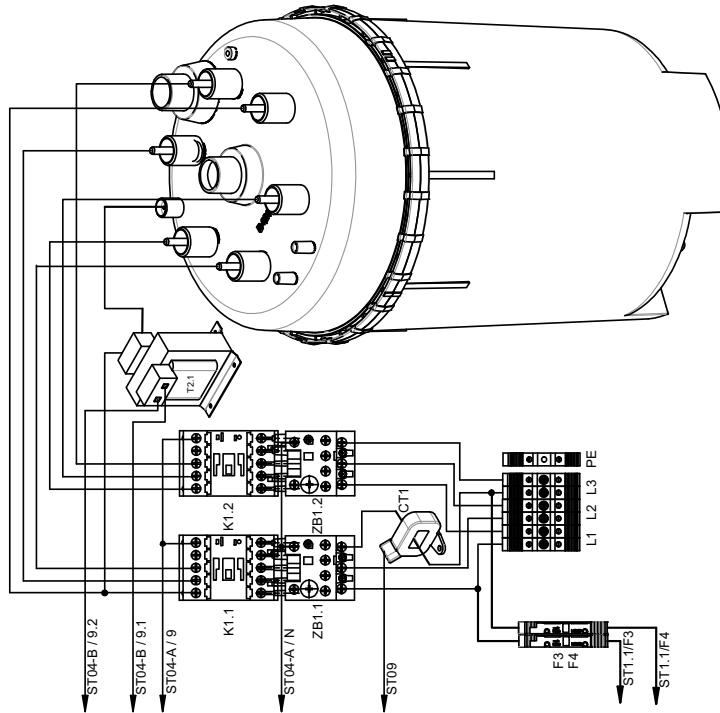

Right cylinder
Rechter Zylinder
Cylindre droit

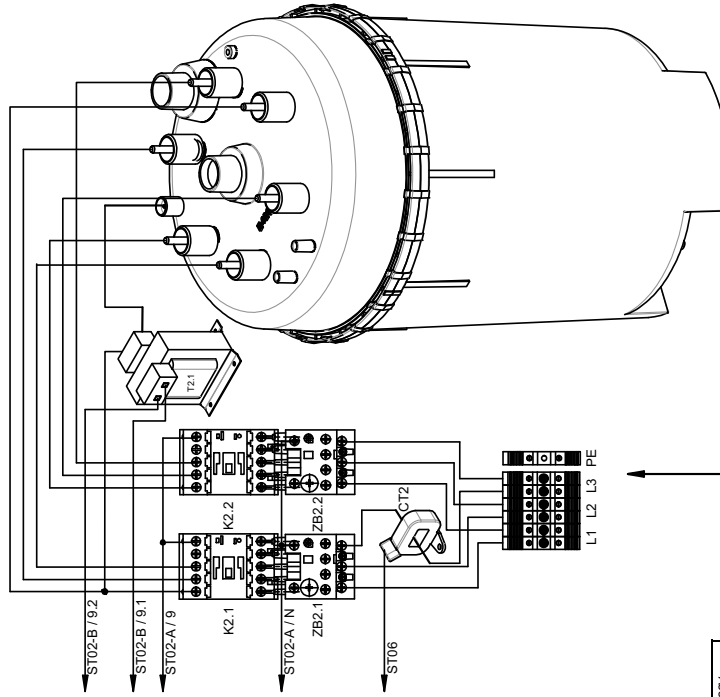

L1	heating voltage 500 - 690V; see name plate
L2	Heizspannung 500 - 690V; siehe Typenschild
L3	Tension de chauffage 500 - 690V; note plaque d'identification

Use copper conductors only, AWG size according current value on the name plate
Leitungsquerschnitt Kupferkabel gemäß Stromangaben auf dem Typenschild
Utiliser uniquement des conducteurs en cuivre, AWG selon la valeur actualée sur la plaque d'identification

Voltage according name plate
Spannung gemäß Typenschild
Tension conformément à la plaque d'identification

HYGROMATIK		Lise-Meiner-Str. 3 24558 Henselck-Utzburg Tel.: +49(0)41933695-0 Fax: +49(0)41933695-33						
A	release	11.11.17	Lue	06.06.2018	Datum	FLE 80-130		(Zeichnung Nr.)
B	Steuersg. int.	25.01.18	Lue	21.06.2018	Bearb.	S-43-002B.06		
Rev.	Änderung	Datum	Name	Gepr.	Norm	heating voltage: 500 - 690V		

7.3 FLH Single cylinder units

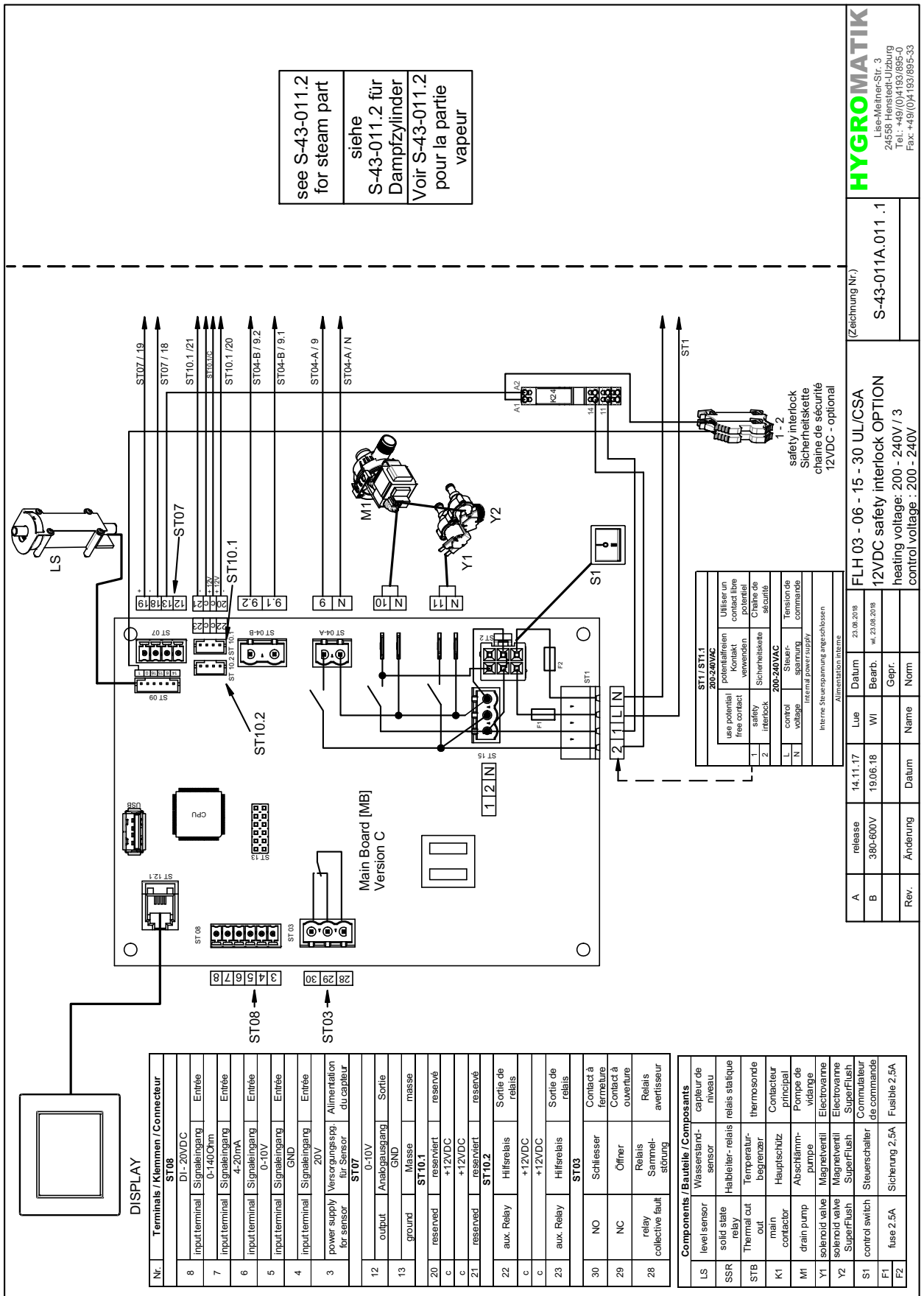

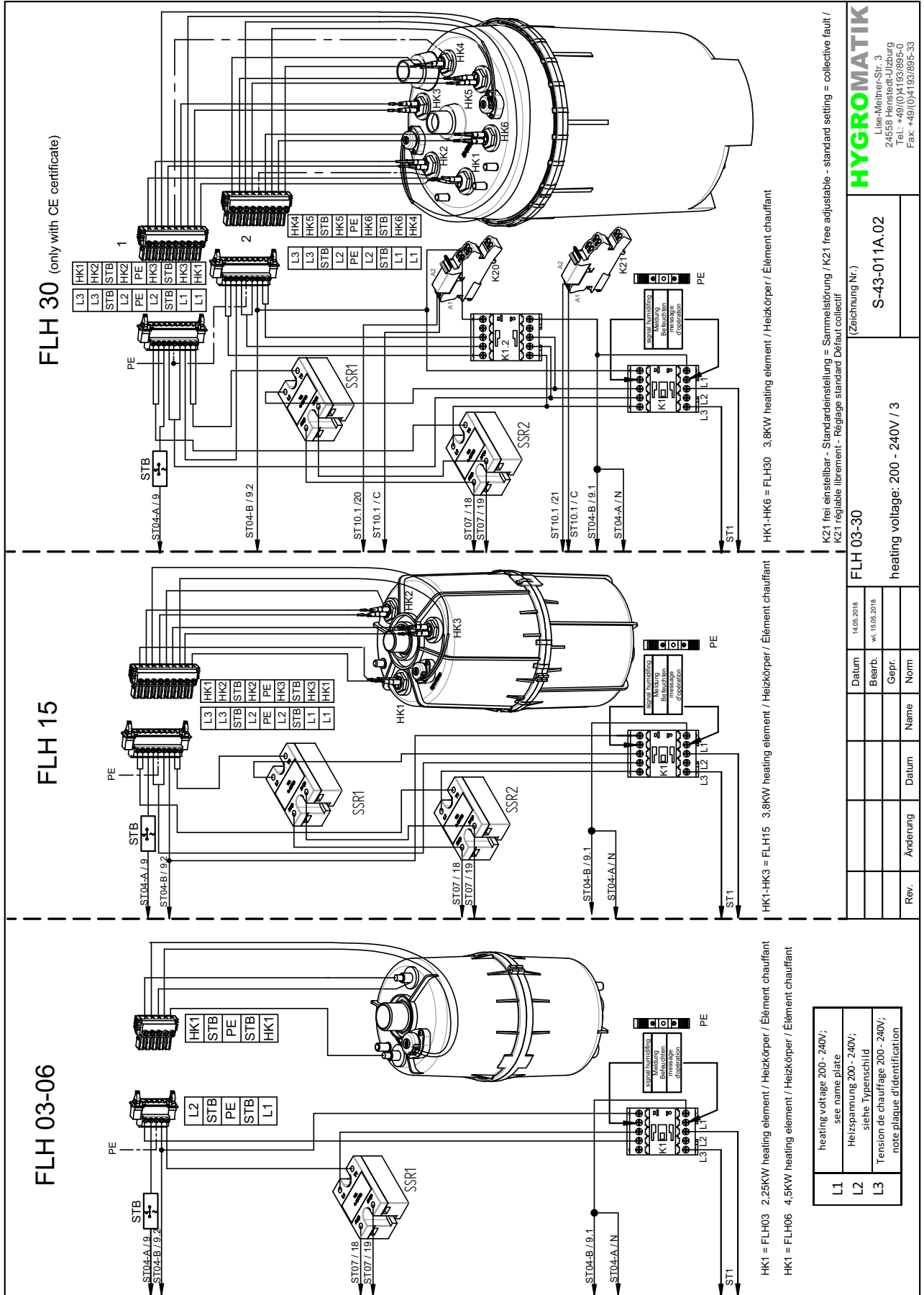

K21 frei einstellbar - Standard-einstellung = Sammelstörung / K21 free adjustable - standard setting = collective fault /
 K21 réglable librement - Réglage standard Défaut collectif

HYGROMATIK
 Lise-Meiner-Str. 3
 24558 Henstedt-Liżburg
 Tel. +49/(0)4193/895-0
 Fax: +49/(0)4193/895-33

FLH 03-30
 S-43-011A.02
 (Zeichnung Nr.)

Rev.	Änderung	Datum	Name	Norm

Rev.	Änderung	Datum	Name	Norm

Rev.	Änderung	Datum	Name	Norm

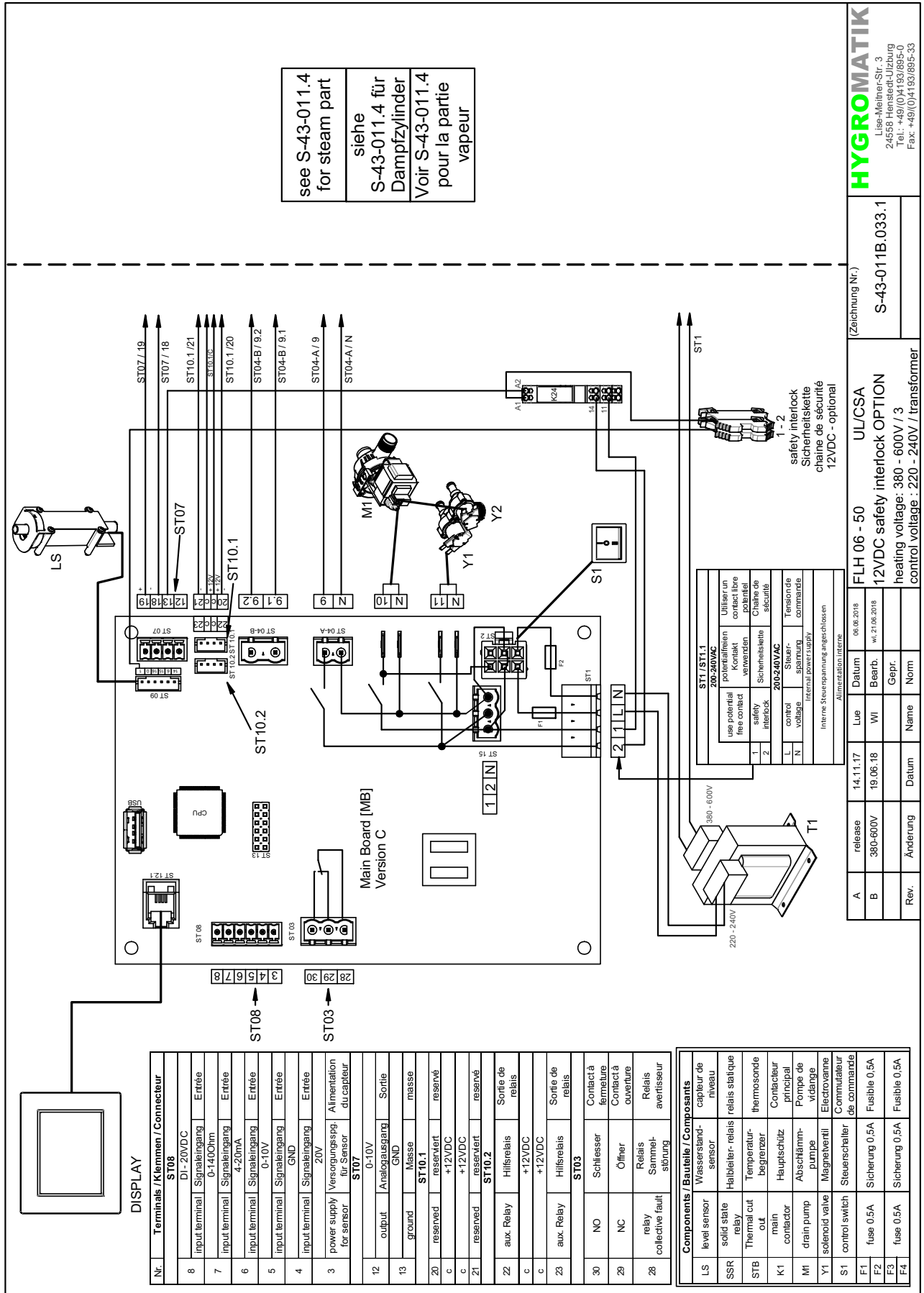

DISPLAY

Nr.	Terminale / Klemmen / Connecteur
ST08	
8	DI-20VDC
	Input terminal Signaleingang Entrée
7	0-140Ohm
	Input terminal Signaleingang Entrée
6	4-20mA
	Input terminal Signaleingang Entrée
5	0-10V
	Input terminal Signaleingang Entrée
4	GND
	Input terminal Signaleingang Entrée
3	20V
	power supply Versorgungspp. Alimentation
	for sensor für Sensor du capteur
ST07	
12	0-10V
	output Analogausgang Sortie
13	GND
	ground Masse masse
ST10.1	
20	reserved
	reserved +12VDC
c	+12VDC
	reserved
21	reserved
	reserved
ST10.2	
22	aux. Relay
	Hilfsrelais relais
c	+12VDC
	Sortie de relais
23	aux. Relay
	Hilfsrelais relais
ST03	
30	NO
	Schliesser Contact à fermeture
29	NC
	Contact à ouverture
28	relay collective fault
	Relais Sammelströmung Relais avertisseur

Components / Bauteile / Composants

LS	level sensor	Wasserstandsensor	capteur de niveau
SSR	solid state relay	Halbleiterrelais	relais statique
STB	Thermal cut out	Temperaturbegrenzer	thermosonde
K1	main contactor	Hauptschutz principal	Contacteur principal
M1	drain pump	Abschlämmpumpe	Pompe de vidange
Y1	solenoid valve	Magnetventil	Electrovanne
S1	control switch	Steuerschalter	Commutateur de commande
F1	fuse 0.5A	Sicherung 0.5A	Fusible 0.5A
F2	fuse 0.5A	Sicherung 0.5A	Fusible 0.5A
F3	fuse 0.5A	Sicherung 0.5A	Fusible 0.5A
F4	fuse 0.5A	Sicherung 0.5A	Fusible 0.5A

ST1/ST1.1	200-240VAC
1	use potential free contact
2	safety interlock
L	control voltage
N	internal power supply

UL/CSSA
 FLH 06 - 50
 12VDC safety interlock OPTION
 heating voltage: 380 - 600V / 3
 control voltage: 220 - 240V / transformer

HYGROMATIK
 Lise-Melher-Str. 3
 24558 Hensched-Ulzburg
 Tel.: +49/(0)4193/895-0
 Fax: +49/(0)4193/895-33

(Zeichnung Nr.)
S-43-011B.033.1

Rev.	Änderung	Datum	Name	Norm
A	release	14.11.17	Lue	06.05.2018
B		380-600V	WI	19.06.18
			Gepr.	14.11.17

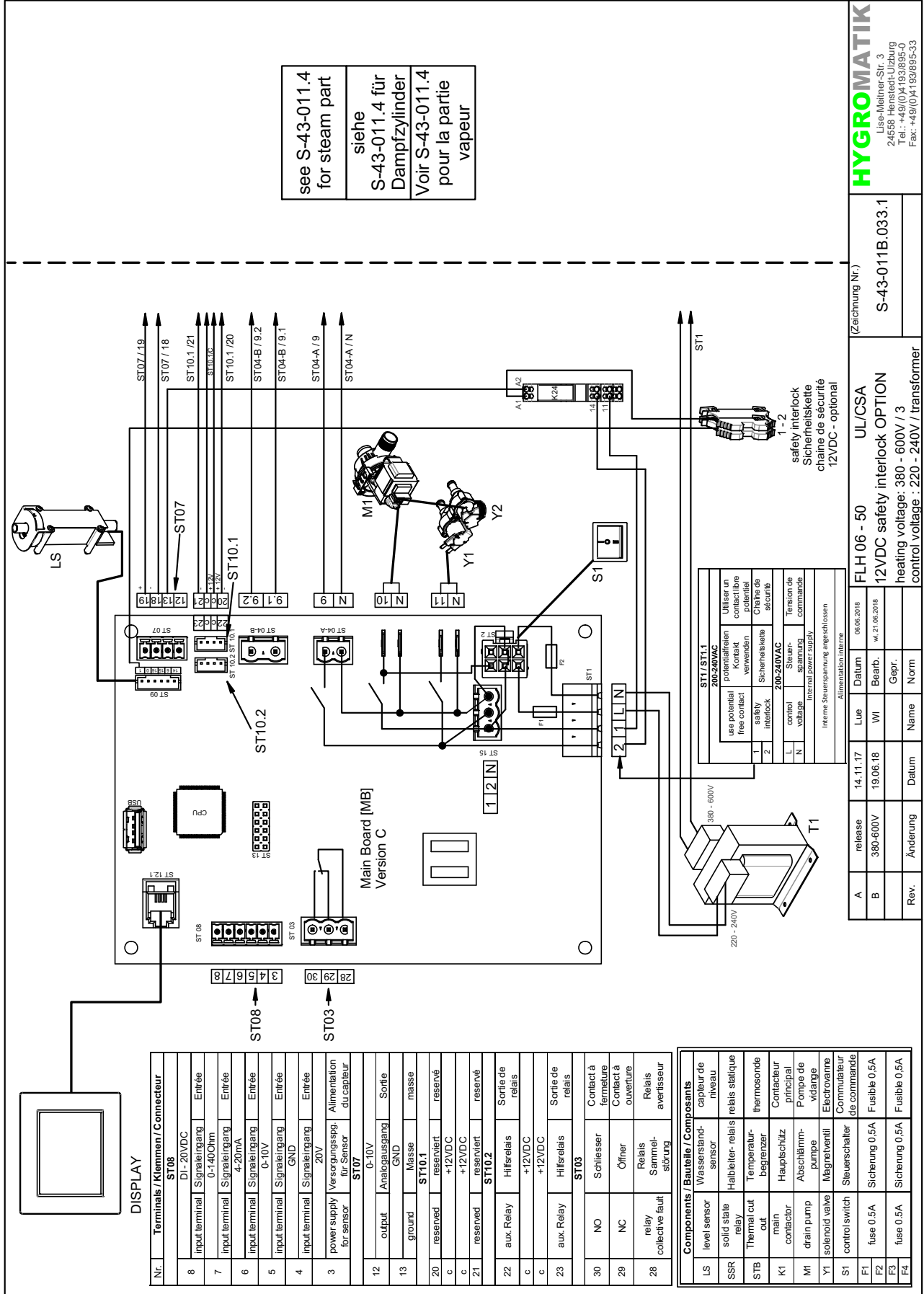

see S-43-011.4
for steam part
siehe
S-43-011.4 für
Dampfzylinder
Voir S-43-011.4
pour la partie
vapeur

HYGROMATIK
Lise-Melmer-Str. 3
24558 Hemsreit-Ubburg
Tel.: +49(0)4193695-0
Fax: +49(0)4193695-33

(Zeichnung Nr.)
S-43-011B.033.1

UL/CSA
FLH 06 - 50
12VDC safety interlock OPTION
heating voltage : 380 - 600V / 3
control voltage : 220 - 240V / transformer

use potential free contact	Utiliser un contact libre
1 safety interlock	Sicherheitsschleife
2 control voltage	Tension de commande
L N	interne Steuerung
	Internal power supply
	Alimentation interne

A	release	14.11.17	Lue	Datum	06.06.2018
B	380-600V	19.06.18	WI	Bearf.	W. 21.06.2018
Rev.	Änderung	Datum	Name	Norm	

Nr.	Terminals / Klemmen / Connecteur
ST06	
8	DI: 20VDC
	input terminal / Signaleingang / Entrée
7	0-1400Ohm
	input terminal / Signaleingang / Entrée
6	4-20mA
	input terminal / Signaleingang / Entrée
5	0-10V
	input terminal / Signaleingang / Entrée
4	GND
	input terminal / Signaleingang / Entrée
3	20V
	power supply / Versorgungsspg. / Alimentation
	for sensor / für Sensor / du capteur
ST07	
12	0-10V
	output / Ausgansgang / Sortie
13	GND
	ground / Masse / misse
ST10.1	
20	reserved
	reserved / +12VDC
c	+12VDC
21	reserved
	reserved / +12VDC
c	+12VDC
ST10.2	
22	aux. Relay
	Hilfsrelais / Sortie de relais
c	+12VDC
ST10.3	
23	aux. Relay
	Hilfsrelais / Sortie de relais
ST10.4	
30	NO
	Contact à fermeture / Contact à ouverture
29	NC
	Contact à fermeture / Contact à ouverture
28	relay collective fault
	Relais Sammelstörung / Relais avertisseur

Components / Bauteile / Composants	
LS	level sensor / Wasserstandsensor / capteur de niveau
SSR	solid state relay / Halbleiterrelais / relais statique
STB	Thermal cut out / Temperaturbegrenzer / thermostonide
K1	main contactor / Hauptschutzpumpe / Contacteur principal
M1	drain pump / Magnetventil / Pompe de vidange
Y1	solenoid valve / Magnetventil / Electrovanne
S1	control switch / Steuerschalter / Commutateur de commande
F1	fuse 0.5A / Sicherung 0.5A / Fusible 0.5A
F2	fuse 0.5A / Sicherung 0.5A / Fusible 0.5A
F3	fuse 0.5A / Sicherung 0.5A / Fusible 0.5A
F4	fuse 0.5A / Sicherung 0.5A / Fusible 0.5A

7.4 FLH Double cylinder units

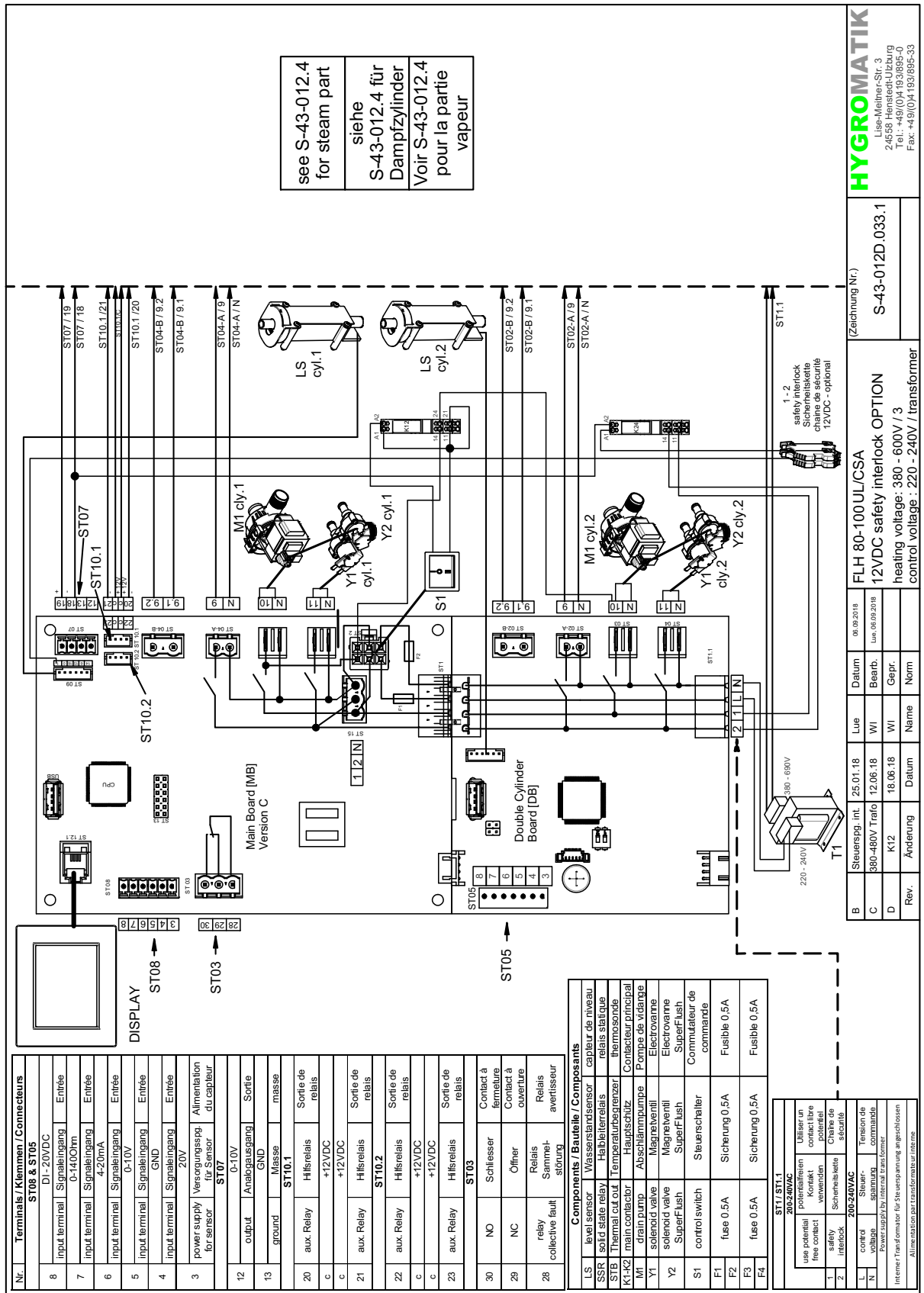

see S-43-012.4
for steam part
siehe
S-43-012.4 für
Dampfzylinder
Voir S-43-012.4
pour la partie
vapeur

HYGROMATIK
Lise-Meine-Str. 3
24558 Henstedt-Ulzburg
Tel.: +49(0)4193895-0
Fax: +49(0)4193895-33

(Zeichnung Nr.)
S-43-012D.033.1

FLH 80-100UL/CSA
12VDC safety interlock OPTION
heating voltage : 380 - 600V / 3
control voltage : 220 - 240V / transformer

Rev.	Änderung	Datum	Name	Norm
B	Steuerspg. int.	25.01.18	Lue	Datum
C	380-480V Trafó	12.06.18	WI	Bearb.
D	K12	18.06.18	WI	Gepr.

Nr.	Terminals / Klemmen / Connecteurs
ST08 & ST05	
8	DI-20VDC input terminal Signaleingang Entrée
7	0-1400mm input terminal Signaleingang Entrée
6	4-20mA input terminal Signaleingang Entrée
5	0-10V input terminal Signaleingang Entrée
4	GND input terminal Signaleingang Entrée
3	20V power supply Versorgungsppg Alimentation for sensor für sensor du capteur
ST07	
12	0-10V output Anabg Ausgang Sortie
13	GND ground Masse masse
20	aux Relay Hilfrelais Sortie de relais
c	+12VDC +12VDC
21	aux Relay Hilfrelais Sortie de relais
c	+12VDC +12VDC
22	aux Relay Hilfrelais Sortie de relais
c	+12VDC +12VDC
23	aux Relay Hilfrelais Sortie de relais
ST03	
30	NO Schliesser Contact à fermeture
28	NC Öffner Contact à ouverture
26	relay Sammel- Relais collective fault störuing avertisseur

Components / Bauteile / Composants	
LS	level sensor Wassersensordensensor capteur de niveau
SSR	solid state relay Halbleitrelais relais statique
STB	Thermal cut out Temperaturbegrenzer thermostonde
K1-K2	main contactor Hauptschlüssler Contacteur principal
M1	drain pump Abschlammpumpe Pompe de vidange
Y1	solenoid valve Magnetventil Electrovanne
Y2	solenoid valve Magnetventil Electrovanne
S1	SuperFlush control switch SuperFlush Steuerschalter Commutateur de commande
F1	fuse 0.5A Sicherung 0,5A Fusible 0,5A
F2	fuse 0.5A Sicherung 0,5A Fusible 0,5A
F3	fuse 0.5A Sicherung 0,5A Fusible 0,5A
F4	fuse 0.5A Sicherung 0,5A Fusible 0,5A

ST1 / ST1.1	200-240VAC	200-240VAC
1	power potential use potential freie contact verwendung Utiliser in contact potentiel	12VDC sicherheit potentiel
2	safety interlock Sicherheitskette sécurité Chaîne de sécurité	
L	control circuit Steuer- spannung Tension de commande	
N	ground potential Schutzpotential Nullpotential Potentiel de terre	

Interne Transformator für Steuerspannung angeschlossen
Internal transformer for Steuerspannung angeschlossen
Alimentation par transformateur interne.

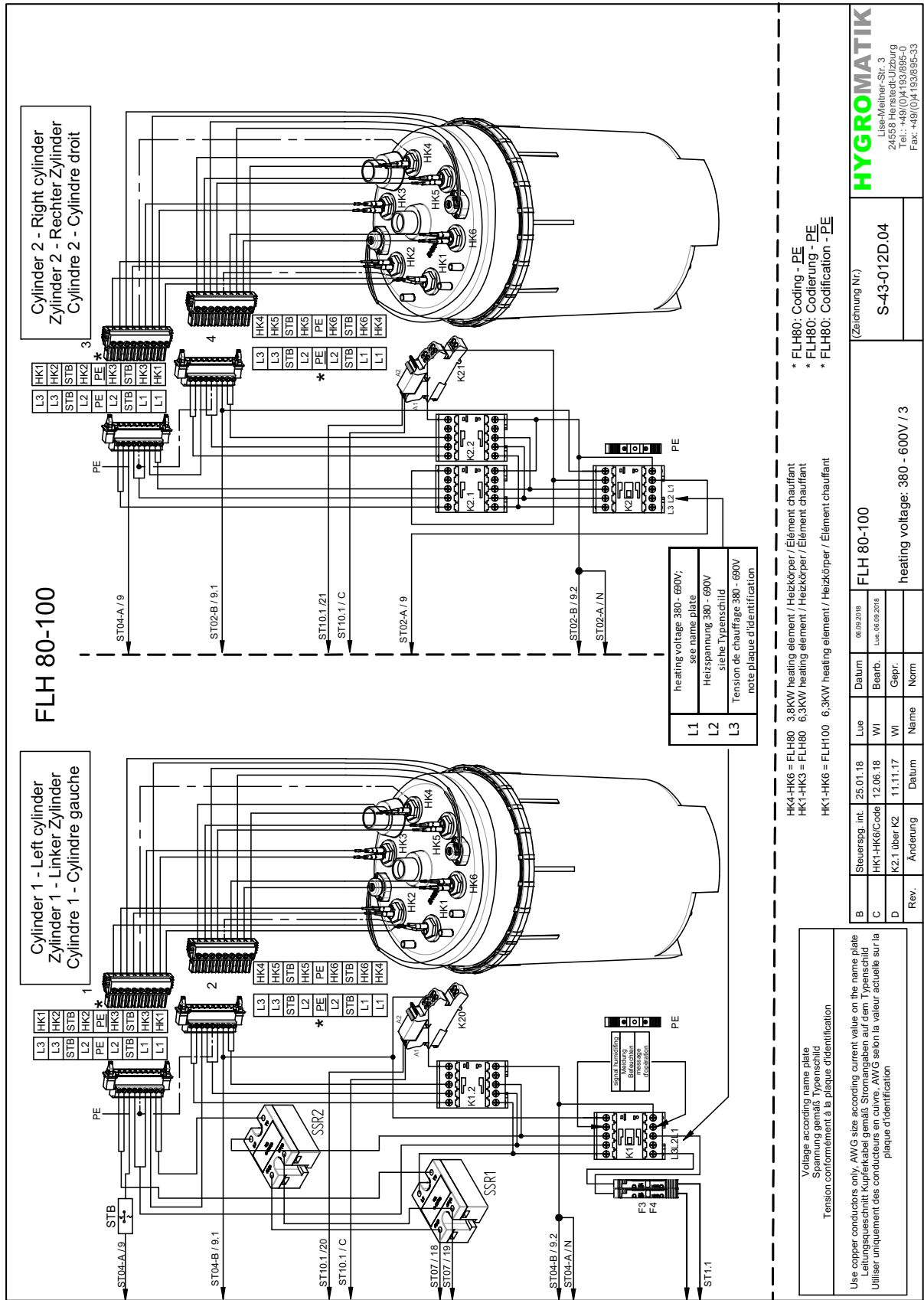

HYGROMATIK
Lies-Meiner-Str. 3
24558 Herstedt-Lübburg
Tel.: +49(0)4193/895-0
Fax: +49(0)4193/895-33

(Zzeichnung Nr.)
S-43-012D.04

Rev.	Änderung	Datum	Name	Norm
B	Steuerplg. int.	25.01.18	Lue	
C	HK1-HK6/Code	12.06.18	WI	
D	K2.1 über K2	11.11.17	WI	

Rev.	Änderung	Datum	Name	Norm
		08.09.2018	FLH 80-100	
	Bearb.	10.08.2018		
	Gepr.			

7.5 FLP Single cylinder units

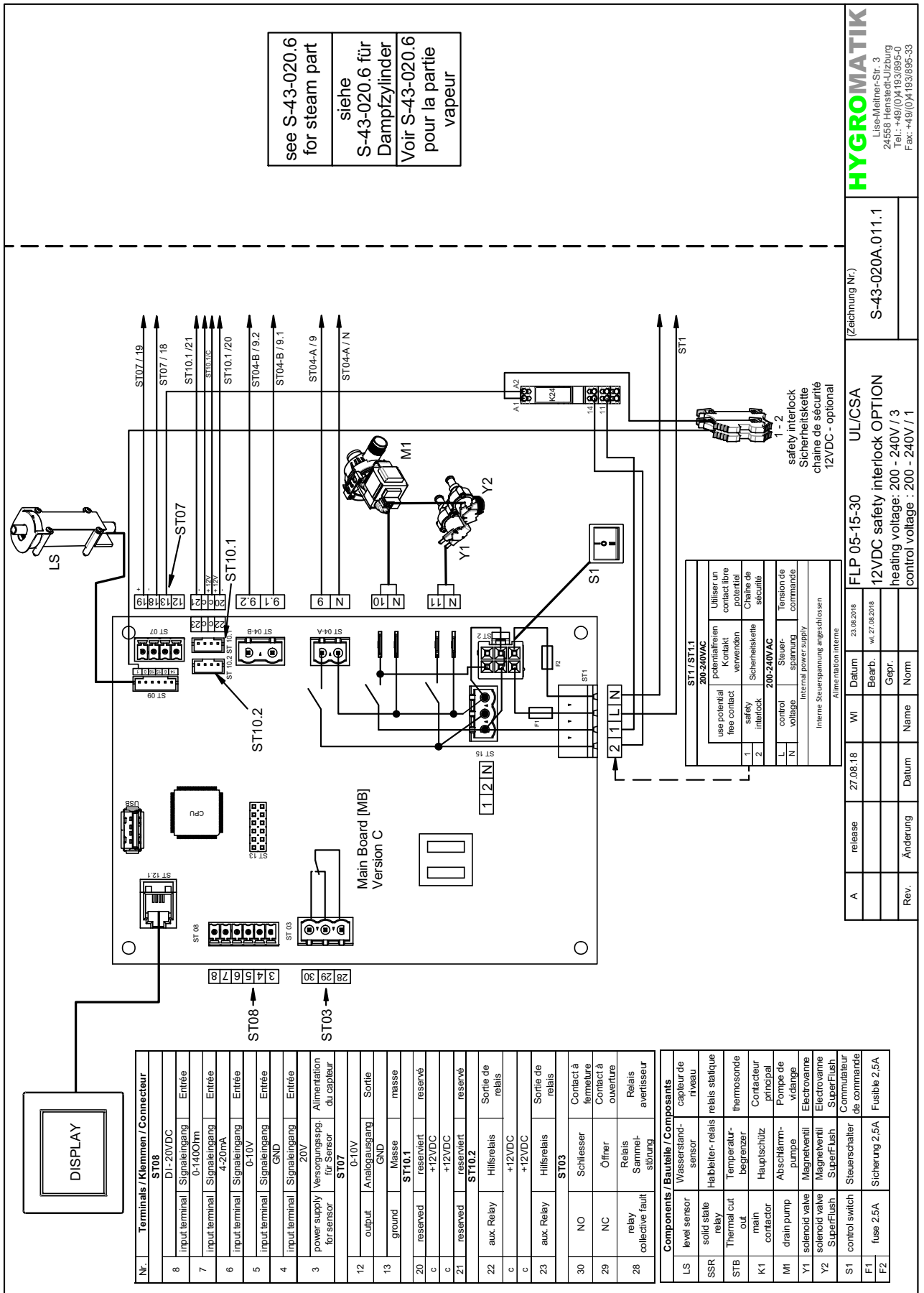

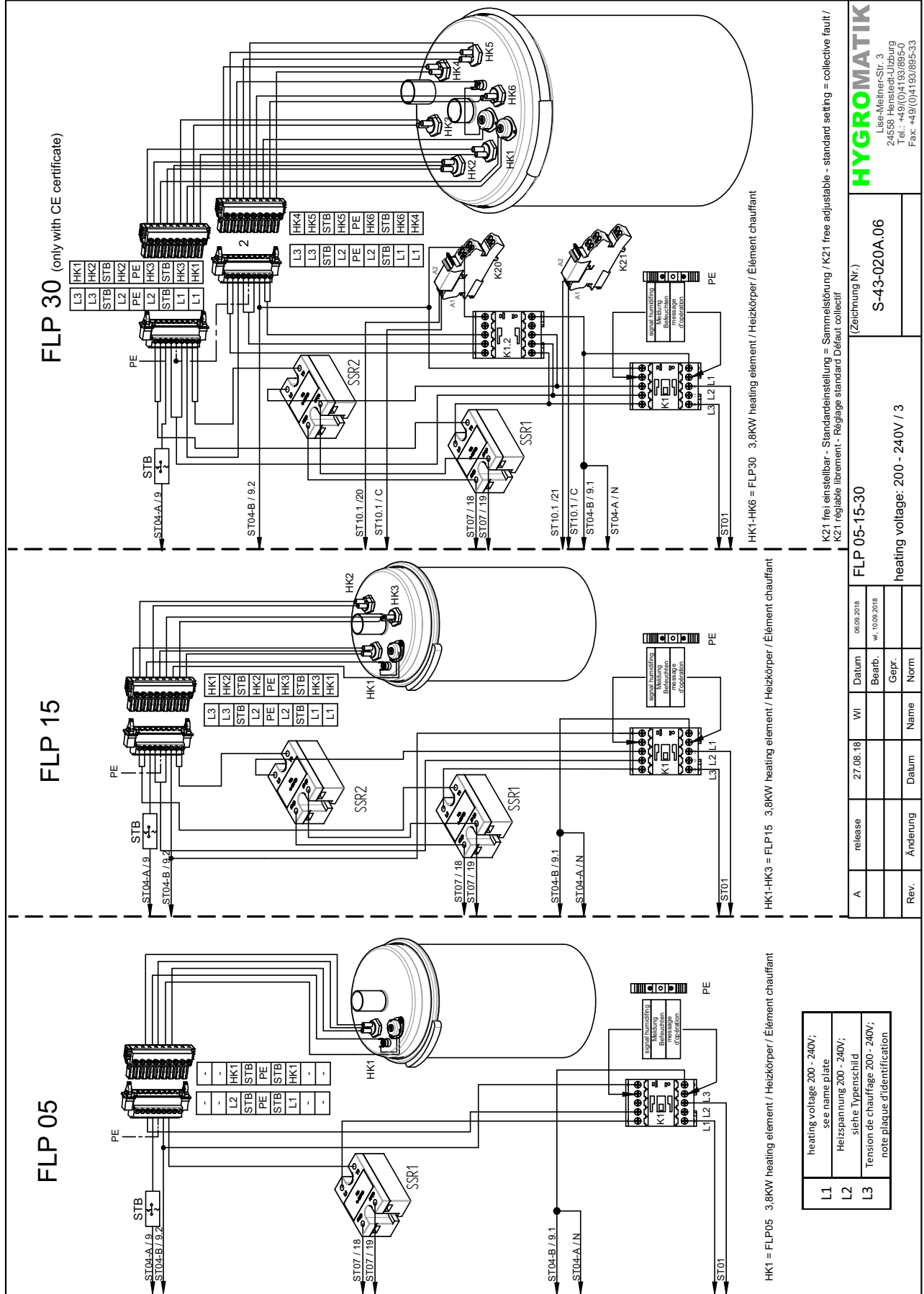

L1	heating voltage 200 - 240V; see name plate
L2	Heizspannung 200 - 240V; siehe Typenschild
L3	Tension de chauffage 200 - 240V; note plaque d'identification

HYGROMATIK
 Lise-Meiher-Str. 3
 24538 Henselort-Jürgburg
 Tel. +49(0)4193/895-33
 Fax. +49(0)4193/895-33

(Zeichnung Nr.)
S-43-020A.06

FLP 05-15-30
 heating voltage: 200 - 240V / 3

Rev.	Änderung	Datum	Name	Norm
A	release	27.08.18	WI	Datum
			Bearb.	06.09.2018
			Gepr.	10.09.2018

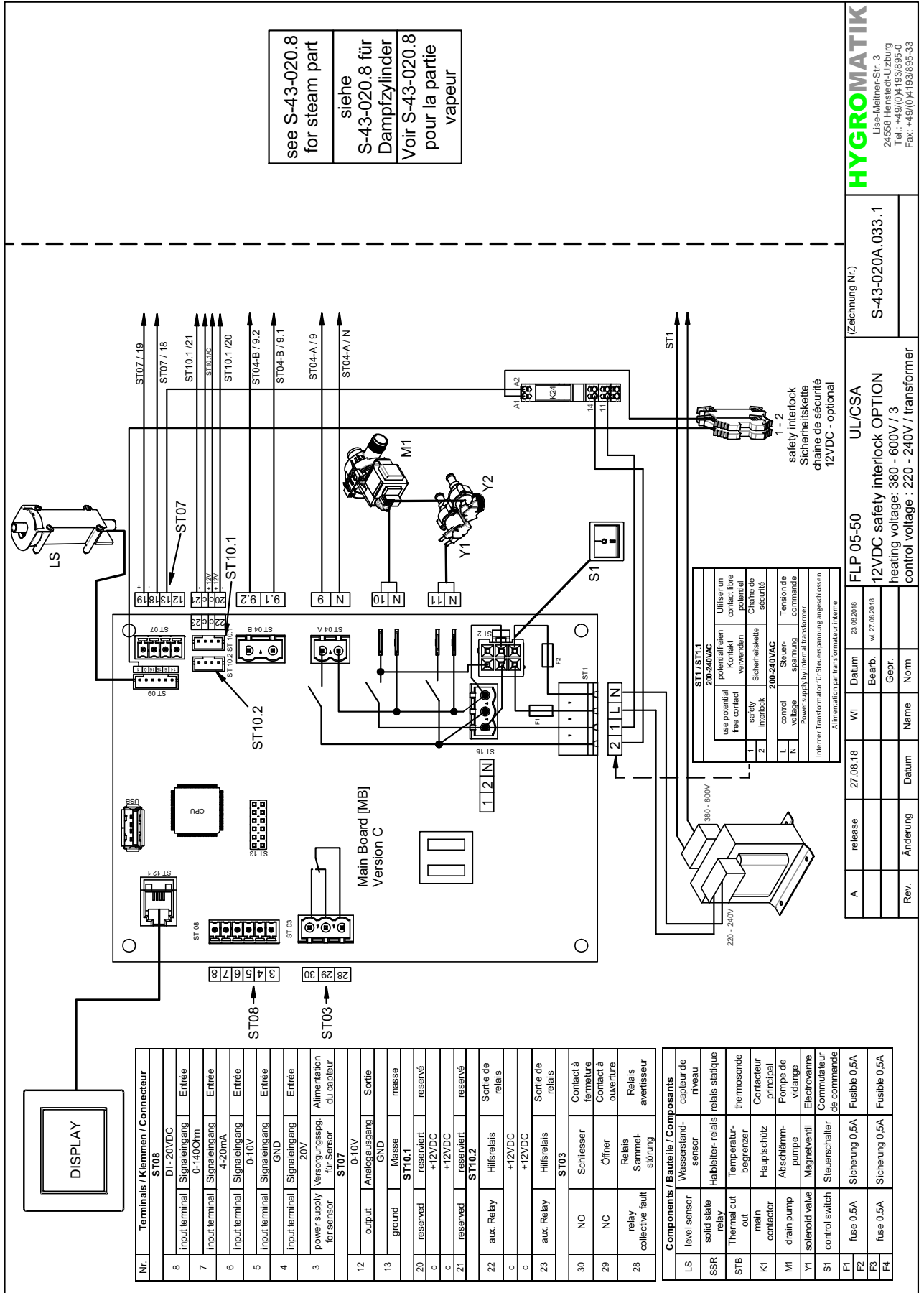

see S-43-020.8
for steam part

siehe
S-43-020.8 für
Dampfzylinder

Voir S-43-020.8
pour la partie
vapeur

Nr.	Terminals / Klemmen / Connecteur
ST08	
8	DI-20VDC
	input terminal Signaleingang Entrée
7	0-1400rpm
	input terminal Signaleingang Entrée
6	4-20mA
	input terminal Signaleingang Entrée
5	0-10V
	input terminal Signaleingang Entrée
4	GND
	input terminal Signaleingang Entrée
3	20V
	power supply Versorgungssppg Alimentation
	for sensor für Sensor du capteur
ST07	
	output Analogausgang Sortie
12	0-10V
	output Analogausgang Sortie
13	GND
	ground Masse masse
ST10.1	
20	reserved
	reserved
c	+12VDC
c	+12VDC
21	reserved
	reserved
ST10.2	
22	aux. Relay
	Hilfsrelais Sortie de relais
c	+12VDC
c	+12VDC
ST03	
30	NO
	Schliesser Contact à fermeture
29	NC
	Offner Contact à ouverture
28	relay collective fault
	Relais Sammel-avertisseur

Components / Bauteile / Composants	Wasserstand- capteur de niveau
LS	solid state relay
SSR	Halbleiter-relais
STB	Thermal cut out
K1	main contactor
M1	drain pump
Y1	solenoid valve
S1	control switch
F1	fuse 0.5A
F2	fuse 0.5A
F3	fuse 0.5A
F4	fuse 0.5A

ST1/ST1.1	200-240VAC
1	use potential free contact
2	safety interlock
L	control voltage
N	sparring
Interne Transformator für Steuerspannung angeschlossen	

HYGROMATIK
Lise-Meiners-Str. 3
24558 Henstedt-Liżburg
Tel.: +49(0)4193/895-0
Fax: +49(0)4193/895-33

release	27.08.18	WI	Datum	23.08.2018
Rev.	Änderung	Name	Geprf.	Norm
FLP 05-50 UL/CSA 12VDC safety interlock OPTION heating voltage: 380 - 600V / 3 control voltage: 220 - 240V / transformer				

(Zeichnung Nr.)
S-43-020A.033.1

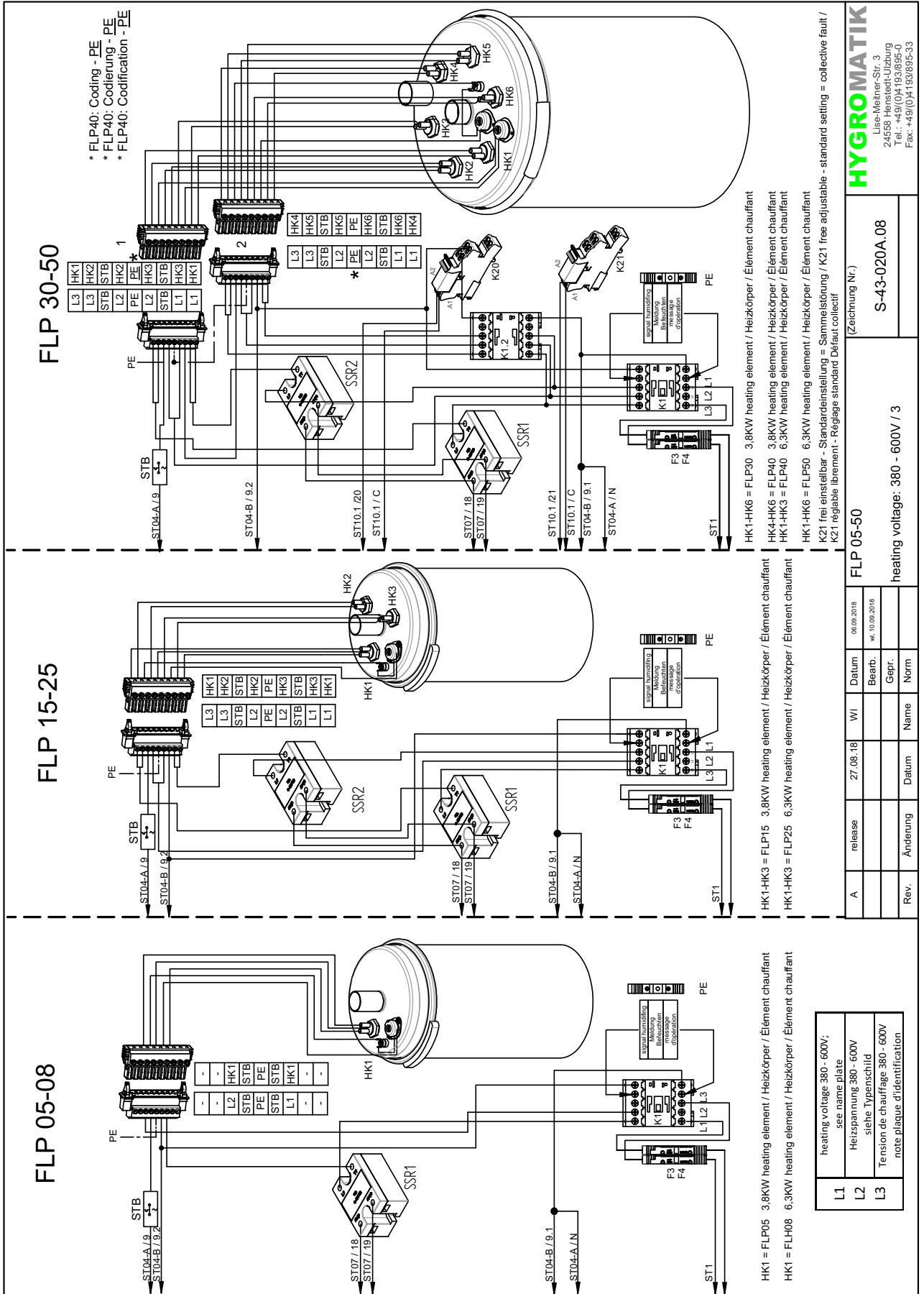

HYGROMATIK
 Lisa-Melmer-Str. 3
 24538 Henseloh
 Tel.: +49(0)471 93895-0
 Fax: +49(0)471 93895-33

(Zeichnung Nr.)
S-43-020A.08

FLP 05-50
 heating voltage: 380 - 600V / 3

Rev.	Änderung	Datum	Name	Norm
A	release	27.08.18	WI	Datum 06.09.2018 Bearb. w. 10.09.2018

7.6 FLP Process single cylinder units

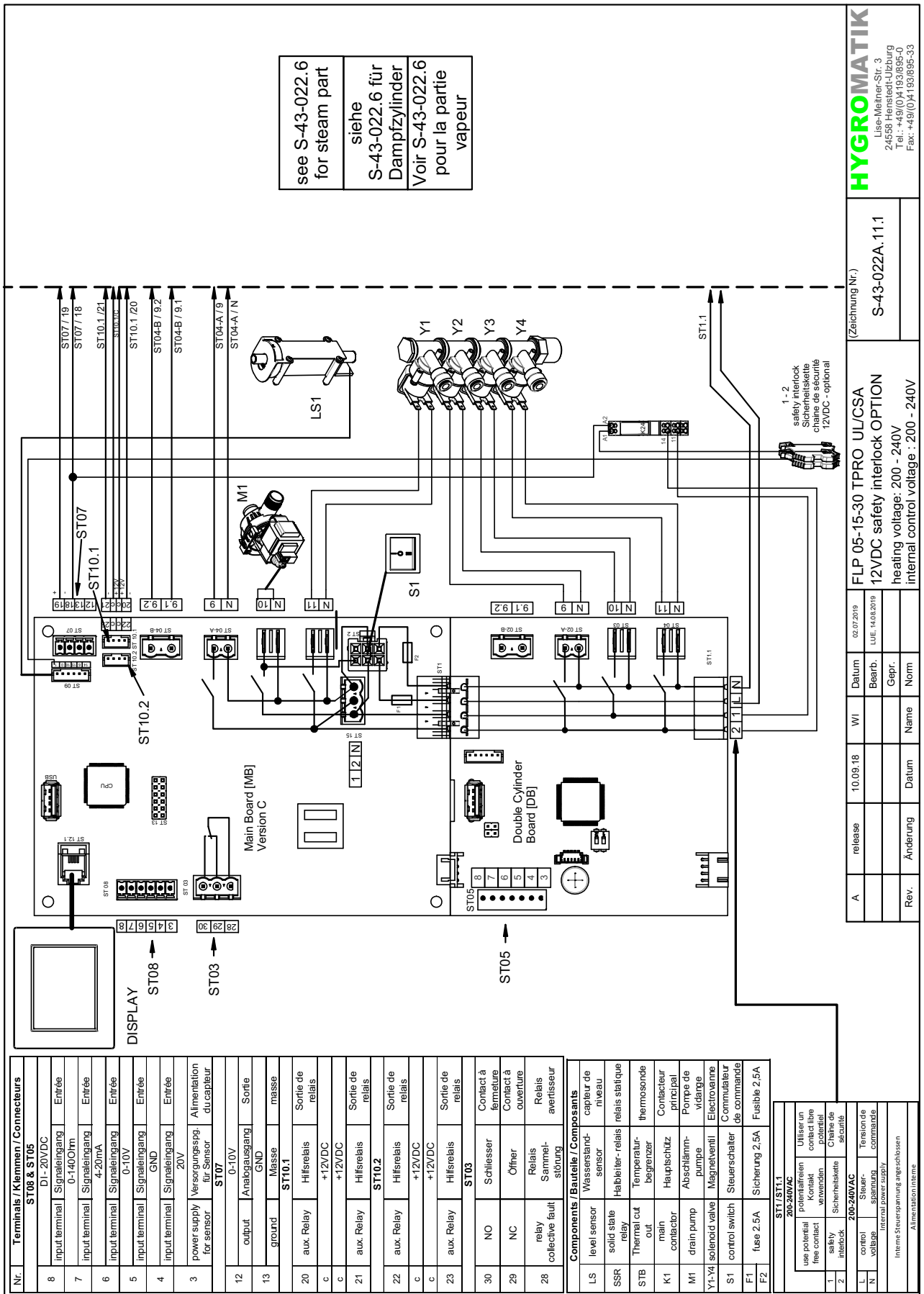

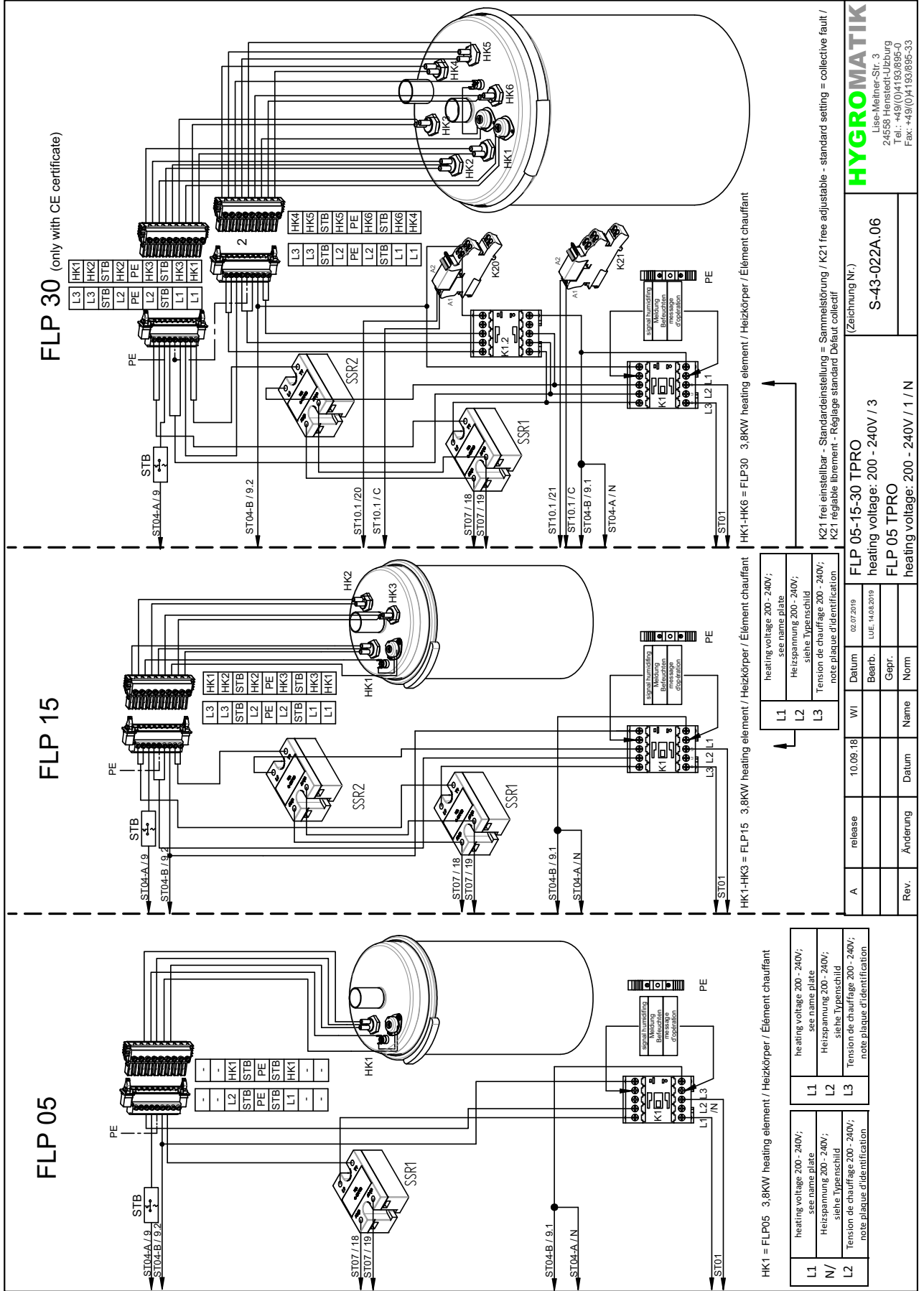

FLP 30 (only with CE certificate)

FLP 15

FLP 05

HK1-HK3 = FLP30 3,8KW heating element / Heizkörper / Élément chauffant

HK1-HK3 = FLP15 3,8KW heating element / Heizkörper / Élément chauffant

L1	heating voltage 200 - 240V; see name plate
L2	Heizspannung 200 - 240V; siehe Typenschild
L3	Tension de chauffage 200 - 240V; note plaque d'identification

L1	heating voltage 200 - 240V; see name plate
L2	Heizspannung 200 - 240V; siehe Typenschild
L3	Tension de chauffage 200 - 240V; note plaque d'identification

L1	heating voltage 200 - 240V; see name plate
N/	Heizspannung 200 - 240V; siehe Typenschild
L2	Tension de chauffage 200 - 240V; note plaque d'identification

HK1 = FLP05 3,8KW heating element / Heizkörper / Élément chauffant

K21 frei einstellbar - Standardeneinstellung = Sammelstörung / K21 free adjustable - standard setting = collective fault /
K21 réglable librement - Réglage standard Défaüt collectif

HYGROMATIK	
(Zeichnung Nr.)	
S-43-022A.06	
FLP 05-15-30 TPRO	
heating voltage: 200 - 240V / 3	
FLP 05 TPRO	
heating voltage: 200 - 240V / 1 / N	
Rev.	Änderung
Datum	Name
Gepr.	Norm
Bearb.	LUE: 14.08.2019
Datum	08.07.2019
WI	

see S-43-022.8
for steam part

siehe
S-43-022.8 für
Dampfzylinder

Voir S-43-022.8
pour la partie
vapeur

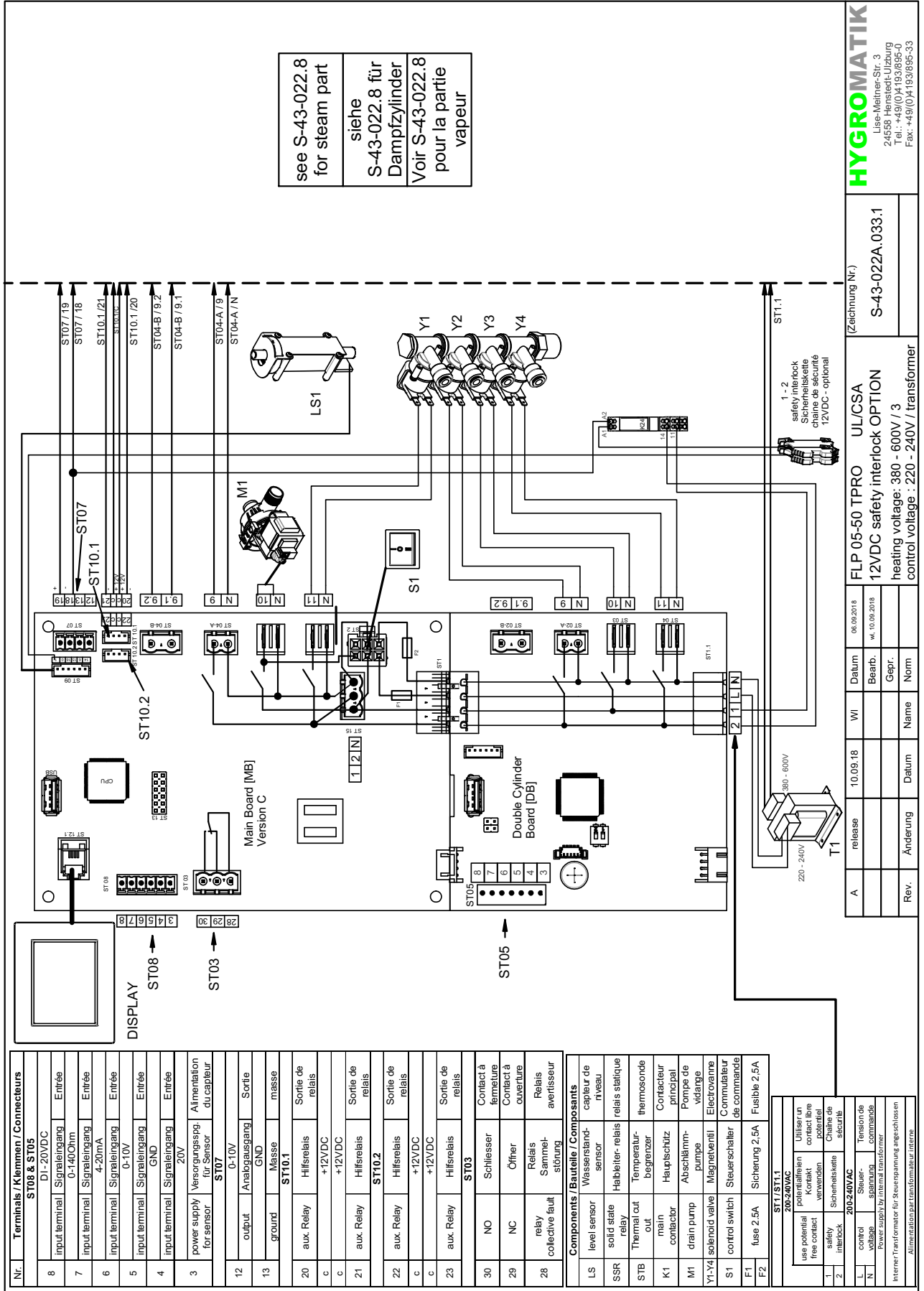

Nr.	Terminals / Klemmen / Connecteurs
ST05 & ST05	
8	input terminal Signaleingang Entrée
7	input terminal Signaleingang Entrée
6	input terminal Signaleingang Entrée
5	input terminal Signaleingang Entrée
4	input terminal Signaleingang Entrée
3	power supply for sensor Alimentation pour capteur
ST08	
28	output Analogausgang Sortie
29	ground Masse masse
30	output Hilfsrelais Sortie de relais
31	output Hilfsrelais Sortie de relais
32	output Hilfsrelais Sortie de relais
33	output Hilfsrelais Sortie de relais
34	output Hilfsrelais Sortie de relais
35	output Hilfsrelais Sortie de relais
36	output Hilfsrelais Sortie de relais
37	output Hilfsrelais Sortie de relais
38	output Hilfsrelais Sortie de relais

Components / Bauteile / Composants	
LS	level sensor Wasserstand-sensor
SSR	solid state relay Halbleiter-relais
STB	thermal out Temperaturbegrenzer
K1	main contactor Hauptschütz
M1	drain pump Abschlämp-pumpe
Y1-Y4	solenoid valve Magnetventil
S1	control switch Steuerschalter
F1	fuse 2.5A Sicherung 2,5A
F2	fuse 2.5A Sicherung 2,5A

ST07/ST1.1	
1	use potential free contact Utiliser un contact libre
2	safety interlock Sicherheitskette
L	control voltage Steuerungsspannung
N	power supply to internal transformer Stromversorgung für interne Transformator
PE	ground Masse

ST07/ST1.1	
1	use potential free contact Utiliser un contact libre
2	safety interlock Sicherheitskette
L	control voltage Steuerungsspannung
N	power supply to internal transformer Stromversorgung für interne Transformator
PE	ground Masse

HYGROMATIK
Lise-Meiher-Str. 3
24558 Hensbeck-Litzburg
Tel.: +49(0)4193/895-0
Fax: +49(0)4193/895-33

(Zeichnung Nr.)
S-43-022A.033.1

FLP 05-50 TPRO UL/CSA
12VDC safety interlock OPTION
heating voltage: 380 - 600V / 3
control voltage: 220 - 240V / transformer

Rev.	Änderung	Datum	Name	Gepr.	Norm.
A	release	10.09.18	WI	08.09.2018	
				10.09.2018	

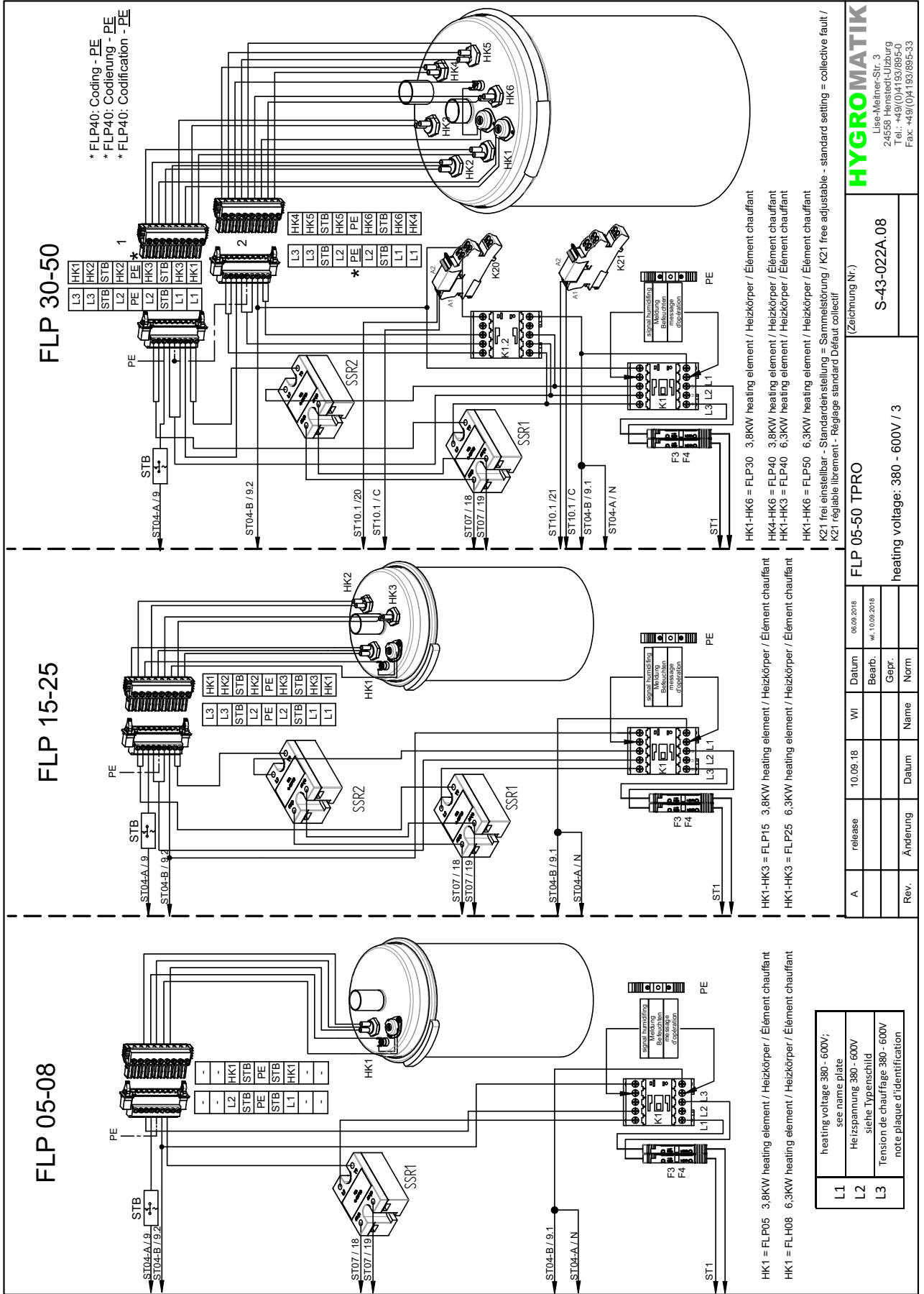

L1	heating voltage 380 - 600V; see name plate
L2	Heizspannung 380 - 600V siehe Typenschild
L3	Tension de chauffe 380 - 600V note plaque d'identification

HYGROMATIK
 Lise-Melmer-Str. 3
 24558 Henstedt-Ulzburg
 Tel.: +49(0)4193/895-0
 Fax: +49(0)4193/895-33

S-43-02ZA.08
 (Zeichnung Nr.)

FLP 05-50 TPRO
 heating voltage: 380 - 600V / 3

Rev.	Änderung	Datum	Name	Gepr.	Norm
A	release	10.09.18	WI	Datum	08.09.2018
				Bearb.	WI:10.09.2018

8. Glossary

Term	[Index]	Explanation
Actual value	1	The actual value is the measured value of a physical quantity, which is compared with the → <i>Set value</i> [3] during the control process and may give rise to a readjustment, if required.
Relative humidity (r.h.)	2	The relative humidity (r.h.) describes the maximum percentage of moisture which the ambient air can hold at a certain temperature.
Set value	3	The set value of a physical quantity (e.g. the → <i>r. h.</i> [2]) is the set target for a control process.
Steam output	4	The steam output calculated from the electrical power consumption in lbs.
Demand	5	The demand describes the dimensionless control signal processed by the control system which is converted into a proportional → <i>Internal actuator signal</i> [42] for the power control for steam generation.
Hygrostat	6	Sensor with switching function for the → <i>Relative humidity (r.h.)</i> [2] in rooms. The trigger point for the switching function with potential free contacts can be set mechanically. The hygrostat can be used to control → <i>1 step operation</i> [44] or in the → <i>Interlock (safety) system</i> [11] to protect against excess humidity.
Update function	7	The update function provides the control with an update of parameter settings which is stored on an external USB memory stick. The "Update function" parameter is a read-only value which can be used to read out the status of the update.
SI system of units	8	The system of units with the temperature specified in °C and the quantity specified in kg.
Imperial system of units	9	The system of units used in the USA with the temperature specified in °F (Fahrenheit) and the quantity specified in lbs or tn.sh. .
Initialisation	10	The control performs a self-test, during which the welcome screen with the software version is displayed. After the parameter settings and measured values have been read in, the → <i>Main screen</i> [14] is shown on the display. During the subsequent start blow-down, the read values can be used to query the device status, which is "Initialisation" in this phase.
Interlock (safety) system	11	The hardware interlock (safety) system makes it possible to immediately interrupt steam production, e.g. using an emergency stop button. The interlock (safety) system must be closed to operate the unit. The interlock (safety) system must be implemented on-site with one or several potential free contacts (switched in series). It is connected to the control at terminals 1 and 2, with terminal 1 carrying 230 VAC as standard. In a special design (e.g. for the U.S. market), the interlock (safety) system is converted to low voltage through the additional use of a relay to meet local safety requirements. Instead of terminals 1 and 2 on the control, a potential free connection of the relevant DIN rail terminals must then be implemented on-site. If the interlock (safety) system is opened, the status of the unit changes to "Interlock (safety) system open".
Software control command	12	Coded command, which is, for example, sent from the building control system or a PLC via the → <i>Communication interface</i> [13] to the control. The command set available is listed in separate documentation, which is available from HygroMatik on request.
Communication interface	13	Serial computer interface for remote control of the unit using, for example, the → <i>Modbus</i> [17] RTU protocol.
Main screen	14	Screen content during the normal operation of the unit. The main screen includes the main display (in the middle of the screen) and the status icons (left and right of the main display).
Standby heating	16	So that steam production can be started more quickly, the standby heating keeps the water in the cylinder warm, if no → <i>Demand</i> [5] is present. The → <i>Interlock (safety) system</i> [11] must be closed. Heating and pause times are adjustable.
Modbus	17	Modbus is a communications protocol for serial data transmission for the remote control of units, which is widely used in industry. HygroMatik controls use the MODBUS - RTU (remote terminal unit) variant. Separate documentation is available upon request from HygroMatik.
Timer function	18	The timer makes it possible to limit the duration of steam production in the short-time range, starting when steam production is halted (if no demand exists in normal operation), or ECO mode . The timer is triggered by pressing a button, which must be connected to the <i>digital input</i> [97] of the mainboard. In addition, the → <i>Digital function</i> [98] parameter must be set to "Timer_start". The "0" setting deactivates the timer. "1" or "2" is used to specify whether the steam is turned off or if there is a return to ECO mode after the timer has elapsed.
Solenoid valve (SV)	19	The solenoid valves for the water supply to the steam cylinder(s) are labelled with Y1, Y2, Y3 and Y4 in the circuit diagrams.
Start blow-down	20	The unit performs a → <i>Blow-down</i> [58] after it was switched off and has been switched on again. The process varies depending on the unit type. For the → <i>ELDB</i> [77] it is important that, when the main contactor is first switched, overcurrent due to excessive conductivity of the cylinder water does not occur while simultaneously water level is high. A → <i>Partial blow-down</i> [21] is therefore used to ensure that the current does not reach an impermissible value. This procedure is not required for the → <i>HKDB</i> [78]. The only checks carried out here are on the functioning of the level control and the blow-down pump, by carrying out a plausibility check of the measured value of the water level sensor which is transferred in the context of a → <i>partial blow-down</i> [21].
Partial blow-down	21	Only part of the cylinder water is pumped off during the → <i>Blow-down</i> [58]. For the → <i>ELDB</i> [77], a partial blow-down is carried out periodically after 40 solenoid valve operating cycles (fillings), when the standard setting is left untouched. For the → <i>HKDB</i> [78], the frequency of the partial blow-down is determined by the steam volume.
Full blow-down	22	All of the cylinder water is pumped off during the → <i>Blow-down</i> [58].
Dilution	23	A dilution is a → <i>Partial blow-down</i> [21], which is caused by excessive conductivity of the cylinder water. For deconcentration, fresh water is used to top up the cylinder after the partial blow-down.

Glossary ctd. (1)

Term	[Index]	Explanation
Overcurrent blow-down	24	Depending on the selection of the → <i>Control curve</i> , the current is increased to 128% or 113% of the nominal current during a cold start, in order to achieve a quick start characteristic. When the respective current value has been reached, the overcurrent blow-down is started causing the nominal current to revert to the normal value (only for → <i>ELDB [77]</i>).
Max. level blow-down	25	When the water level sensor signals the maximum level, a → <i>Partial blow-down [21]</i> is carried out to reduce the water level (only for → <i>HKDB [78]</i>).
Stand-by blow-down	26	If the unit was switched on for an extended period without a → <i>Demand [5]</i> arising, or if the → <i>Interlock (safety) system [11]</i> was opened for an extended period, a (→ <i>Blow-down [58]</i>) of the cylinder water is performed to prevent germ formation. The interval for triggering the blow-down is defined with the "Standby blow-down interval" parameter.
Flushing of dead-end line	27	When this function is activated, the feed water line is flushed during operation phases in which there are no requests in order to prevent germ formation. For this purpose, the inlet solenoid valve and the blow-down pump are activated at the same time. The "Flushing_of_dead-end_line_interval" parameter determines when flushing starts after a request was not received, the "Flushing_of_dead-end_line_duration" parameter determines how long flushing takes. The interlock (safety) system must be closed so that the inlet solenoid valve can be controlled ("partially automatic flushing of dead-end line").
Manual blow-down	28	Pumping out of the cylinder water by touching the "Blow-down" icon on the screen or by a → <i>Software control command [12]</i> via the → <i>Communication interface [13]</i> . Repeated actuation or a corresponding → <i>Software command [12]</i> switches the → <i>Blow-down function [58]</i> off again). The cylinder water may also be pumped by setting the control switch on the device front panel in the "II" position while the control remains switched off.
Thermo sensor	31	With the → <i>HKDB [78]</i> , a thermo sensor is located on the cylinder cover, connected to the heater(s) via a capillary tube. A thermal switch is also arranged on every → <i>Solid state relay [46]</i> . All thermo sensors/thermal switches are connected in series. If one of the thermo sensors/thermal switches is triggered, the power supply to the steam humidifier is interrupted. The thermo sensor(s) on the cylinder(s) have to be reset mechanically after cooling down. The thermal switches are automatically reset after cooling down.
Limitation of operating time	32	The unit stops the steam production according to the number of minutes specified. The time is counted from the point when the interlock (safety) system was closed. To put the unit back into operation, the interlock (safety) system must be opened and closed again, or the → <i>Communication interface [13]</i> must be used to transmit → <i>Software control commands [12]</i> to open and close the virtual interlock (safety) system again. Alternatively, the control switch can also be opened and closed again. This does, however, cause the unit to be restarted. Setting the parameter to a value of "0" deactivates the limitation of operating time.
Steam_amount_service	33	The steam volume produced [tn.sh.] is compared to the default value set in the "Steam_amount_service" parameter to obtain a criterion for maintenance requirements. Once the default value has been reached, the message "Steam_amount_counter" is displayed. Once the service has been performed, the steam volume counter has to be reset with "Service_reset_cyl. x". The remaining steam volume can be viewed using the "Steam_until_msg_cyl. x" read value.
Service_main_contactor	34	The operating cycles of the main contactor(s) are recorded by counters and compared to factory-set default values by the software. When a default value is reached, the "Service_main_contactor x" message is displayed on the screen. After a main contactor has been replaced, the respective counter must be reset with the parameter "Main_contactor_x_Reset" (x = number of the main contactor, 1...5).
Floating max. limiter	35	<p>The floating max. limiter is an additional function when the control is operated with the internal PI controller. It serves for protection against excessive humidification of the channel. In case of the room sensor sending a demand while the channel has already reached its maximum humidity capacity, a floating max. limiter allows for a much more sensitive limitation of the steam supply when compared to a max. hygrostat. While the max- hygrostat switches off only when the maximum humidity is reached, the floating max. limiter tracks the humidity progress and turns down the steam production based on a settable control curve until a defined max. humidity is reached. This aims to ensure that no excessive humidification may occur in the channel.</p> <p>To use this function, a 2nd humidity sensor must be mounted in the channel (typical routing position is the range where the steam is introduced into the channel by the humidifier).</p> <p>Connecting the 2nd humidity sensor</p> <p>If the unit only features a mainboard (i.e. no additional relay board), the 1st humidity sensor must be of the "Humidity sensor with 0...10 V output voltage" type to allow for the implementation of the floating max. limiter function. The second humidity sensor is then wired to the current input of the mainboard. To allow for this, the sensor must feature a 4...20 mA current output signal. In case of a relay board built into the unit, however, the 2nd humidity sensor is to be wired to this board making use of the 0...10 V voltage input, just as is the case with the mainboard. Consequently, the humidity sensor must be of the 0...10 V voltage type.</p> <p>Activating the floating max. limiter</p> <p>Activating is accomplished by setting the "Control settings" parameter in submenu "Control" to "11" or "12". The setting must be in accordance with the wiring chosen for the 2nd humidity sensor. If no 2nd humidity sensor is connected, the parameter setting is not saved.</p> <p>Example: The 2nd humidity sensor was connected to the current input of the mainboard. For the "Control settings" parameter, the "11" is to be chosen as the setting value.</p> <p>Parameter settings for the floating max. limiter</p> <p>For the floating turning-down of the humidity set value, the control curve steepness may be set with the "PI-controller_max_gain" parameter. Factory pre-setting (FP) is "5". The humidity set value for the shut-down point is defined by the "Humidity_set_max" parameter (FP = 80%).</p>

Glossary ctd. (2)

Term	Index	Explanation
Overcurrent blow-down	24	Depending on the selection of the → <i>Control curve</i> , the current is increased to 128% or 113% of the nominal current during a cold start, in order to achieve a quick start characteristic. When the respective current value has been reached, the overcurrent blow-down is started causing the nominal current to revert to the normal value (only for → <i>ELDB [77]</i>).
Max. level blow-down	25	When the water level sensor signals the maximum level, a → <i>Partial blow-down [21]</i> is carried out to reduce the water level (only for → <i>HKDB [78]</i>).
Stand-by blow-down	26	If the unit was switched on for an extended period without a → <i>Demand [5]</i> arising, or if the → <i>Interlock (safety) system [11]</i> was opened for an extended period, a (→ <i>Blow-down [58]</i>) of the cylinder water is performed to prevent germ formation. The interval for triggering the blow-down is defined with the "Standby blow-down interval" parameter.
Flushing of dead-end line	27	When this function is activated, the feed water line is flushed during operation phases in which there are no requests in order to prevent germ formation. For this purpose, the inlet solenoid valve and the blow-down pump are activated at the same time. The "Flushing_of_dead-end_line_interval" parameter determines when flushing starts after a request was not received, the "Flushing_of_dead-end_line_duration" parameter determines how long flushing takes. The interlock (safety) system must be closed so that the inlet solenoid valve can be controlled ("partially automatic flushing of dead-end line").
Manual blow-down	28	Pumping out of the cylinder water by touching the "Blow-down" icon on the screen or by a → <i>Software control command [12]</i> via the → <i>Communication interface [13]</i> . Repeated actuation or a corresponding → <i>Software command [12]</i> switches the → <i>Blow-down function [58]</i> off again. The cylinder water may also be pumped by setting the control switch on the device front panel in the "II" position while the control remains switched off.
Thermo sensor	31	With the → <i>HKDB [78]</i> , a thermo sensor is located on the cylinder cover, connected to the heater(s) via a capillary tube. A thermal switch is also arranged on every → <i>Solid state relay [46]</i> . All thermo sensors/thermal switches are connected in series. If one of the thermo sensors/thermal switches is triggered, the power supply to the steam humidifier is interrupted. The thermo sensor(s) on the cylinder(s) have to be reset mechanically after cooling down. The thermal switches are automatically reset after cooling down.
Limitation of operating time	32	The unit stops the steam production according to the number of minutes specified. The time is counted from the point when the interlock (safety) system was closed. To put the unit back into operation, the interlock (safety) system must be opened and closed again, or the → <i>Communication interface [13]</i> must be used to transmit → <i>Software control commands [12]</i> to open and close the virtual interlock (safety) system again. Alternatively, the control switch can also be opened and closed again. This does, however, cause the unit to be restarted. Setting the parameter to a value of "0" deactivates the limitation of operating time.
Steam_amount_service	33	The steam volume produced [kg] is compared to the default value set in the "Steam_amount_service" parameter to obtain a criterion for maintenance requirements. Once the default value has been reached, the message "Steam_amount_counter" is displayed. Once the service has been performed, the steam volume counter has to be reset with "Service_reset_cyl. x". The remaining steam volume can be viewed using the "Steam_until_msg_cyl. x" read value.
Service_main_contactor	34	The operating cycles of the main contactor(s) are recorded by counters and compared to factory-set default values by the software. When a default value is reached, the "Service_main_contactor x" message is displayed on the screen. After a main contactor has been replaced, the respective counter must be reset with the parameter "Main_contactor_x_Reset" (x = number of the main contactor, 1..5).
Floating max. limiter	35	<p>The floating max. limiter serves for protection against excessive humidification of the channel. In case of the room sensor sending a demand while the channel has already reached its maximum humidity capacity, a floating max. limiter allows for a much more sensitive limitation of the steam supply when compared to a max. hygostat. While the max- hygostat switches off only when the maximum humidity is reached, the floating max. limiter tracks the humidity progress and turns down the steam production based on a settable control curve until a defined max. humidity is reached. This aims to ensure that no excessive humidification may occur in the channel.</p> <p>To use this function, a 2nd humidity sensor must be mounted in the channel (typical mouting position is the range where the steam is introduced into the channel by the humidifier).</p> <p>Connecting the 2nd humidity sensor</p> <p>If the unit only features a mainboard, the 1st humidity sensor must be of the "Humidity sensor with 0...10 V output voltage" type to allow for the implementation of the floating max. limiter function. The secon humidity sensor is than wired to the current input of the mainboard. To allow for this, the sensor must feature a 4...20 mA current output signal. In case of an additional board built into the unit, however, the 2nd humidity sensor is to be wired to this board making use of the 0...10 V voltage input, just as is the case with the mainboard. Consequently, the humidity sensor must be of the 0...10 V voltage type.</p> <p>Activating the floating max. limiter</p> <p>Activating is accomplished by setting the "Control settings" parameter in submenu "Control" to "11" or "12". The setting must be in accordance with the wiring chosen for the 2nd humidity sensor. If no 2nd humidity sensor is connected, the parameter setting is not saved.</p> <p>Example: The 2nd humidity sensor was connected to the current input of the mainboard. For the "Control settings" parameter, the "11" is to be chosen as the setting value.</p> <p>Parameter settings for the floating max. limiter</p> <p>For the floating turning-down of the humidity set value, the control curve steepness may be set with the "PI-controller_max_gain" parameter. Factory pre-setting (FP) is "5". The humidity set value for the shut-down point is defined by the "Humidty_set_max" parameter (FP = 80%).</p>

Glossary ctd. (3)

Term	[Index]	Explanation
Output signal	69	Signal 0... 10 V on terminals 12 and 13 (GND), which is proportional to the input signal. Can be used to control downstream units.
Input signal	72	The electrical signal fed to the control at the ST08 plug of the mainboard or the ST05 plug of the relay board. Depending on the signal characteristic (Voltage, current or resistivity progress), a certain pin of the corresponding plug is used. The signal range of the input signal (e.g. 0...10V) is to be adapted by setting of the related parameter. Using the <code>Correction_x_signal</code> [49] parameters, the output signal of a humidity sensor may be calibrated.
External controller	73	The control uses the output signal of an external controller to control the power element for steam generation. The input level of the control can be adapted to different signal types and value ranges. Other possible input signals are the output signal of a humidity sensor (in connection with the internal PI controller), the switching contact of a <code>Hygrostat</code> [6] (for <code>1 step operation</code> [44]) and a <code>Software command</code> [12] via the <code>Communication interface</code> [13].
Dropout delay	74	By assigning the "8" value to one of the relay contacts, a control signal for the delayed closing of a steam valve is made available for pressure reduction. The dropout delay is set with the "Humidification_off_delay" parameter. Factory default is 60 s.
Main contactor	75	The installed main contactors are labelled K1...K4. The operating cycles of the main contactor(s) are monitored and compared with the value specified by the manufacturer for the expected service life. When the stored value is reached, the message "Service_main_contactor" is generated. After the main contactor has been replaced, the status message must be deleted, for example using the <code>Main_contactor_K1_Reset = "1"</code> parameter.
ELDB	77	Electrode steam humidifier.
HKDB	78	Heater steam humidifier.
HVAC	79	Heating, Ventilation, Air Condition: Generic term in the English language area for air conditioning equipment.
Virtual interlock (safety) system	86	If control via <code>Communication interface</code> [13] was selected, software is used to place a logical switch in series with the hardware interlock (safety) system. This switch can be opened and closed via <code>Software commands</code> [12]. If the hardware interlock (safety) system is closed and the switch is opened via software control command, steam production is stopped and the unit is placed in "Remote switch-off" status.
Supply voltage	89	The units are designed for connection to supply voltage ranges (e.g. 380 to 415 VAC in case of a 400 VAC unit, s. name plate)
Unit name	90	Here, "Plant 1" is entered by default.
Weekly timer	91	The timer makes it possible to program 2 periods per day of the week, each defined by a start time and an end time. The humidity set-value can be preset for each time period.
Recording	93	The control can record 10 data sets internally on a rolling basis. Snapshots of the unit status are carried out at intervals of 10 s, which can be helpful for troubleshooting. When the storage space is filled, a new set of data overrides the oldest entry. The complete record can be saved to a USB stick with NTFS formatting.
Slave	94	The unit functions as a slave in a master/slave arrangement, where a control unit (master) can control up to 3 slaves for the purpose of improving the output performance of the entire system. The slaves are switched sequentially. The output signal of the master on terminals 12, 13 is connected to the input terminals of the 1. slave. The input signal assignment of the 1st slave (and all subsequent ones) must be set to "Slave", this also applies to the output signal assignment for the master and all slaves.
Warning message	95	The electrodes (for the <code>ELDB</code> [77]), the blow-down pump and the solenoid valves are items with limited service life due to wear and tear. They must be checked during maintenance works and replaced if required. To avoid unplanned maintenance requirements, alerts can be set up for the respective items, which are activated when a defined state of wear is reached. The criteria for the alerts to be triggered can be defined in three stages each through the sensitivity setting.
PI controller	96	Internal controller with control characteristics which contain a Proportional part and an Intergal part. Both parts can be changed as parameters.
Digital input	97	Digital input on the mainboard and on the relay boards for switching functions. A logical meaning (e.g. timer start) is assigned to the digital input via the <code>Digital_input_function</code> [98] parameter. The digital input must be wired on-site in accordance with its use, e.g. with a <code>Pushbutton</code> [106] or a <code>Switch (NO)</code> [102] against the 20 VDC on terminal 8 on the mainboard terminal strip ST08 or the terminal strip ST05 on the other available boards. When the 20 VDC voltage is applied (short-term via a <code>Pushbutton</code> [106] or permanent via a <code>Switch (NO)</code> [102]), as required in accordance with <code>Digital_input_function</code> [98] parameter setting), the switching function is carried out.
Digital_input_function	98	Determines which function will be executed if the <code>Digital input</code> [97] on the mainboard or one of the relay boards is activated by applying an <code>Auxiliary voltage</code> [105], either short-term (via a push-button) or permanent (via a switch).
Nominal power output	99	The steam output range given on the name plate derived from the allowable range of supply voltages

Glossary ctd. (4)

Term	Index	Explanation
Power section	100	That part of the unit that makes the energy conversion from the current supplied into steam output
Load shedding	101	Load shedding can be set up by assigning the →Function_digital_input [98] "Power limitation" to the →Digital input [97]. When the →Digital input [97] is then then connected to an →Auxiliary voltage [105] by means of a →Switch (NO) [102], →Max. steam output [43] is reduced by the percentage set up in the "Δ power limitation" parameter. After withdrawal of the voltage normal operation is reestablished.
Switch (NO)	102	Electrical switch with Normally Open contacts
Steam_down_time_min.	103	Steam-down time between fillings is continuously monitored. If the minimum steam-down time set falls below the value set up several times in a row, an indication exits that the cylinder water conductivity has risen to an extend non tolerable. For conductivity reduction, →Dilution [23] is triggered (only →ELDB [77]).
Slave_hysteresis	104	In order to avoid unnecessary frequent switching on and off of →Slave [94] units (as required by the output demand) or an oscillating tendency, switching is made with a hysteresis. Example: One Master controls one Slave. Switching on the slave without hysteresis would occur at 50% output demand, same situation for switching the slave off. With a 1% hysteresis, switching on the slave is at 51% output demand whereas switching off is at 49%. By this, instability of the switch-off point is accomplished.
Push button	106	Electrical switch for momentary action
Fully automatic deadleg flushing	107	For "fully automatic" →Deadleg flushing [27], an additional relay must be implemented that allows for switching the intake solenoid valve even when the →Interlock (safety) system [11] is open. Control of this additional relay is either by the base relay on the mainboard or a coupling relay. The relay used for this function must have "68" as the assignment.

This page intentionally left blank

9. Technical Data

FLE 208 V

Technical data FlexLine Electrodes					
Unit type	FLE05		FLE10	FLE15	
Steam output [lb/h]	9,3 - 9,3 - 10,6	9,9 - 9,9 - 11,5	15,9 - 15,9 - 18,3	17,2 - 17,2 - 19,8	29,8 - 29,8 - 34,4
Electrical connection ⁽¹⁾	208 - 208 - 240V /1Ph /N /50-60Hz		208 - 208 - 240V /3Ph /50-60Hz		208 - 208 - 240V /3Ph /50-60Hz
Rated power [kW]	3,1 - 3,1 - 3,6	3,4 - 3,4 - 3,9	5,4 - 5,4 - 6,2	5,9 - 5,9 - 6,8	10,2 - 10,2 - 11,7
Nominal current [A]	15 - 15 - 15	9,4 - 9,4 - 9,4	15 - 15 - 15	28,2 - 28,2 - 28,2	
Fuse [A] ⁽²⁾	1 x 15	3 x 15	3 x 15	1 x 35	3 x 35
Connection terminals max. [in ²]	0,2			0,4	
Number of steam cylinder	1				
Control	FlexLine mainboard with capacitive 3.5" touch colour display				
Control voltage ⁽³⁾	208 - 240V 2,5A				
Steam hose connection [in]	1 x 1,0				
Water consumption ⁽⁷⁾ [usgal/h]	5,76	6,24	9,96	10,8	18,72
Water flow rate ⁽⁸⁾ [usgal/min]	0,34 / 5,42			0,74 / 5,81	
Max. filling capacity [usgal]	1,3			3,5	
Empty weight [lb]	35,3			57,3	
Operation weight [lb]	47,0			87,5	
Width ⁽⁹⁾ [in]				21,3	
Height ⁽⁹⁾ [in]	21,1			27,4	
Depth ⁽⁹⁾ [in]				12,6	
Water connection	tap water of varying qualities 1 to 10 bar, für 3/4" Aussengewinde				
Drain water connection	Connection Ø 1 1/4"				

Technical data FlexLine Electrodes							
Unit type	FLE25		FLE30	FLE40	FLE50	FLE80	FLE100
Steam output [lb/h]	36,6 - 36,6 - 42,3	50,9 - 50,9 - 58,6	61,7 - 61,7 - 71,2	63,5 - 63,5 - 73,4	84,7 - 84,7 - 97,7	127,0 - 127,0 - 146,6	169,5 - 169,5 - 195,6
Electrical connection ⁽¹⁾	208 - 208 - 240V /1Ph /N /50-60Hz		208 - 208 - 240V /3Ph /50-60Hz				
Rated power [kW]	12,5 - 12,5 - 14,4	17,3 - 17,3 - 20	21 - 21 - 24,2	21,6 - 21,6 - 24,9	28,8 - 28,8 - 33,3	2 x 21,6 - 21,6 - 24,9	2 x 28,8 - 28,8 - 33,3
Nominal current [A]	60 - 60 - 60	48 - 48 - 48	58,2 - 58,2 - 58,2	60 - 60 - 60	80 - 80 - 80	2 x 60 - 60 - 60	2 x 80 - 80 - 80
Fuse [A] ⁽²⁾	1 x 70	3 x 60	3 x 60	3 x 65	3 x 100	2 x 3 x 65	2 x 3 x 100
Connection terminals max. [in ²]	0,4			1,0			
Number of steam cylinder	1					2	
Control	FlexLine mainboard with capacitive 3.5" touch colour display						
Control voltage ⁽³⁾	208 - 240V 2,5A						
Steam hose connection [in]	1 x 1,6			2 x 1,6 ⁽⁶⁾	2 x 1,6	4 x 1,6 ⁽⁶⁾	4 x 1,6
Water consumption ⁽⁷⁾ [usgal/h]	23,04	31,92	38,76	39,96	53,16	79,8	106,44
Water flow rate ⁽⁸⁾ [usgal/min]	0,74 / 5,81			1,08 / 6,16		2 x / 1,08 / 6,16	
Max. filling capacity [usgal]	3,5		5,5		9,4	11,0	18,9
Empty weight [lb]	57,3		63,9		77,2	152,1	172
Operation weight [lb]	87,5		111,1		157,0	245,4	330,5
Width ⁽⁹⁾ [in]	21,3		22,8		25,2	44,5	46,1
Height ⁽⁹⁾ [in]	27,4		29,5		30,9	29,5	30,9
Depth ⁽⁹⁾ [in]	12,6		14,0		16,5		
Water connection	tap water of varying qualities 1 to 10bar, 1 to 10 bar, for 3/4" external thread						
Drain water connection	Connection Ø 1 1/4"					2x Connection Ø 1 1/4"	

⁽¹⁾ Other voltages on request

⁽²⁾ 1.1 times the current consumption after full blowdown. Observe tripping characteristics of circuit breakers. If necessary, select next higher circuit breaker level

⁽³⁾ Separate control voltage on request

⁽⁶⁾ Including Y-piece DN40

⁽⁷⁾ Maximum water consumption at 100% demand plus blow down losses. Water consumption depends on the water quality and options installed.

⁽⁸⁾ Flow rate of the feed water during refilling or pumping out. Unit without options / maximum rate with options.

⁽⁹⁾ Outer dimensions of width and depth. Height including drain connection

FLE 460 V

Technical data FlexLine Electrodes						
Unit type	FLE05	FLE10	FLE15	FLE20	FLE25	FLE30
Steam output [lb/h]	10,6 - 11,0 - 11,5	21,2 - 22,0 - 22,9	31,5 - 33,1 - 34,4	42,1 - 44,1 - 45,9	52,7 - 55,1 - 57,5	63,3 - 66,1 - 69,0
Electrical connection ⁽¹⁾	440 - 460 - 480V /3Ph /50-60Hz					
Rated power [kW]	3,6 - 3,7 - 3,9	7,2 - 7,5 - 7,8	10,7 - 11,2 - 11,7	14,3 - 15 - 15,6	17,9 - 18,7 - 19,5	21,5 - 22,5 - 23,4
Nominal current [A]	4,7 - 4,7 - 4,7	9,4 - 9,4 - 9,4	14,1 - 14,1 - 14,1	18,8 - 18,8 - 18,8	23,5 - 23,5 - 23,5	28,2 - 28,2 - 28,2
Fuse [A] ⁽²⁾	3 x 10		3 x 20		3 x 35	
Connection terminals max. [in ²]	0,2		0,4			
Number of steam cylinder	1					
Control	FlexLine mainboard with capacitive 3.5" touch colour display					
Control voltage ⁽³⁾	208 - 240V 0,5A					
Steam hose connection [in]	1 x 1,0			1 x 1,6		
Water consumption ⁽⁷⁾ [usgal/h]	6,24	12,48	18,72	24,96	31,32	37,56
Water flow rate ⁽⁸⁾ [usgal/min]	0,34 / 5,42		0,74 / 5,81		1,08 / 6,16	
Max. filling capacity [usgal]	1,3		3,5		5,5	
Empty weight [lb]	44,1		57,3		63,9	
Operation weight [lb]	55,8		87,5		111,1	
Width ⁽⁹⁾ [in]			21,3		22,8	
Height ⁽⁹⁾ [in]	21,1				29,5	
Depth ⁽⁹⁾ [in]			12,6		14,0	
Water connection	tap water of varying qualities 1 to 10bar, 1 to 10 bar, for 3/4" external thread					
Drain water connection	Connection Ø 1 1/4"					

Technical data FlexLine Electrodes						
Unit type	FLE40	FLE50	FLE65	FLE80	FLE100	FLE130
Steam output [lb/h]	84,4 - 88,2 - 92,2	105,6 - 110,2 - 115,1	137,1 - 143,3 - 149,5	168,7 - 176,4 - 184,1	211,0 - 220,5 - 229,3	273,4 - 286,6 - 297,6
Electrical connection ⁽¹⁾	440 - 460 - 480V /3Ph /50-60Hz					
Rated power [kW]	28,7 - 30 - 31,3	35,9 - 37,5 - 39,2	46,6 - 48,8 - 50,9	2 x 28,7 - 30 - 31,3	2 x 35,9 - 37,5 - 39,2	2 x 46,6 - 48,7 - 50,8
Nominal current [A]	37,7 - 37,7 - 37,7	47,1 - 47,1 - 47,1	61,2 - 61,2 - 61,2	2 x 37,7 - 37,7 - 37,7	2 x 47,1 - 47,1 - 47,1	2 x 61,2 - 61,2 - 61,2
Fuse [A] ⁽²⁾	3 x 50	3 x 60	3 x 65	2 x 3 x 50	2 x 3 x 60	2 x 3 x 65
Connection terminals max. [in ²]				1,0		
Number of steam cylinder	1			2		
Control	FlexLine mainboard with capacitive 3.5" touch colour display					
Control voltage ⁽³⁾	208 - 240V 0,5A			208 - 240V 1A		
Steam hose connection [in]	2 x 1,6 ⁽⁶⁾	2 x 1,6		4 x 1,6 ⁽⁶⁾	4 x 1,6	
Water consumption ⁽⁷⁾ [usgal/h]	50,16	62,64	81,36	100,2	124,8	162
Water flow rate ⁽⁸⁾ [usgal/min]	1,08 / 6,16		2 x 1,08 / 6,16			
Max. filling capacity [usgal]	5,5	9,4		11,0	18,9	
Empty weight [lb]	63,9	75,0		152,1	176,4	
Operation weight [lb]	111,1	154,8		245,4	334,9	
Width ⁽⁹⁾ [in]	22,8	25,2		44,5	46,1	
Height ⁽⁹⁾ [in]	29,5	30,9		29,5	30,9	
Depth ⁽⁹⁾ [in]	14,0	16,5				
Water connection	tap water of varying qualities 1 to 10bar, 1 to 10 bar, for 3/4" external thread					
Drain water connection	Connection Ø 1 1/4"			2x Connection Ø 1 1/4"		

⁽¹⁾ Other voltages on request

⁽²⁾ 1.1 times the current consumption after full blowdown. Observe tripping characteristics of circuit breakers.
If necessary, select next higher circuit breaker level.

⁽³⁾ Separate control voltage on request

⁽⁶⁾ Including Y-piece DN40

⁽⁷⁾ Maximum water consumption at 100% demand plus blow down losses. Water consumption depends on the water quality and options installed.

⁽⁸⁾ Flow rate of the feed water during refilling or pumping out. Unit without options / maximum rate with options.

⁽⁹⁾ Outer dimensions of width and depth. Height including drain connection

FLE 600 V

Technical data FlexLine Electrodes						
Unit type	FLE05	FLE10	FLE15	FLE20	FLE25	FLE30
Steam output [lb/h]	10,8 - 11,2 - 11,2	21,6 - 22,7 - 22,7	32,2 - 33,5 - 33,5	43,0 - 45,0 - 45,0	53,8 - 56,2 - 56,2	64,6 - 67,5 - 67,5
Electrical connection ⁽¹⁾	575 - 600 - 600V /3Ph /50-60Hz					
Rated power [kW]	3,7 - 3,8 - 3,8	7,4 - 7,7 - 7,7	11 - 11,4 - 11,4	14,6 - 15,3 - 15,3	18,3 - 19,1 - 19,1	22 - 23 - 23
Nominal current [A]	3,7 - 3,7 - 3,7	7,4 - 7,4 - 7,4	11 - 11 - 11	14,7 - 14,7 - 14,7	18,4 - 18,4 - 18,4	22,1 - 22,1 - 22,1
Fuse [A] ⁽²⁾	3 x 6	3 x 10	3 x 16	3 x 20	3 x 20	3 x 35
Connection terminals max. [in ²]	0,2		0,4			
Number of steam cylinder	1					
Control	FlexLine mainboard with capacitive 3.5" touch colour display					
Control voltage ⁽³⁾	208 - 240V 0,5A					
Steam hose connection [in]	1 x 1,0			1 x 1,6		
Water consumption ⁽⁷⁾ [usgal/h]	6,12	12,36	18,24	24,48	30,6	36,72
Water flow rate ⁽⁸⁾ [usgal/min]	0,34 / 5,42		0,74 / 5,81			1,08 / 6,16
Max. filling capacity [usgal]	1,3		3,5		5,5	
Empty weight [lb]	44,1		57,3		63,9	
Operation weight [lb]	55,8		87,5		111,1	
Width ⁽⁹⁾ [in]	21,3			22,8		
Height ⁽⁹⁾ [in]	21,1		27,4		29,5	
Depth ⁽⁹⁾ [in]	12,6			14,0		
Water connection	tap water of varying qualities 1 to 10bar, 1 to 10 bar, for 3/4" external thread					
Drain water connection	Connection Ø 1 1/4"					

Technical data FlexLine Electrodes						
Unit type	FLE40	FLE50	FLE65	FLE80	FLE100	FLE130
Steam output [lb/h]	86,4 - 90,2 - 90,2	107,8 - 112,4 - 112,4	140,2 - 146,4 - 146,4	172,6 - 180,3 - 180,3	211,4 - 220,5 - 220,5	280,0 - 293,2 - 293,2
Electrical connection ⁽¹⁾	575 - 600 - 600V /3Ph /50-60Hz					
Rated power [kW]	29,4 - 30,7 - 30,7	36,7 - 38,2 - 38,2	47,7 - 49,8 - 49,8	2 x 29,4 - 30,7 - 30,7	2 x 36 - 37,5 - 37,5	2 x 47,7 - 49,8 - 49,8
Nominal current [A]	29,5 - 29,5 - 29,5	36,8 - 36,8 - 36,8	47,9 - 47,9 - 47,9	2 x 29,5 - 29,5 - 29,5	2 x 36,1 - 36,1 - 36,1	2 x 47,9 - 47,9 - 47,9
Fuse [A] ⁽²⁾		3 x 40	3 x 50	2 x 3 x 35	2 x 3 x 40	2 x 3 x 50
Connection terminals max. [in ²]				1,0		
Number of steam cylinder	1			2		
Control	FlexLine mainboard with capacitive 3.5" touch colour display					
Control voltage ⁽³⁾	208 - 240V 0,5A			208 - 240V 1,0A		
Steam hose connection [in]	2 x 1,6 ⁽⁶⁾	2 x 1,6		4 x 1,6 ⁽⁶⁾	4 x 1,6	
Water consumption ⁽⁷⁾ [usgal/h]	49,08	61,2	79,68	98,16	120	159,6
Water flow rate ⁽⁸⁾ [usgal/min]						2 x 1,08 / 6,16
Max. filling capacity [usgal]	5,5	9,4		11,0	18,9	
Empty weight [lb]	63,9	75,0		152,1	176,4	
Operation weight [lb]	111,1	154,8		245,4	334,9	
Width ⁽⁹⁾ [in]	22,8	25,2		44,5	46,1	
Height ⁽⁹⁾ [in]	29,5	30,9		29,5	30,9	
Depth ⁽⁹⁾ [in]	14,0	16,5				
Water connection	tap water of varying qualities 1 to 10bar, 1 to 10 bar, for 3/4" external thread					
Drain water connection	Connection Ø 1 1/4"			2x Connection Ø 1 1/4"		

⁽¹⁾ Other voltages on request

⁽²⁾ 1.1 times the current consumption after full blowdown. Observe tripping characteristics of circuit breakers. If necessary, select next higher circuit breaker level

⁽³⁾ Separate control voltage on request

⁽⁶⁾ Including Y-piece DN40

⁽⁷⁾ Maximum water consumption at 100% demand plus blow down losses. Water consumption depends on the water quality and options installed.

⁽⁸⁾ Flow rate of the feed water during refilling or pumping out. Unit without options / maximum rate with options.

⁽⁹⁾ Outer dimensions of width and depth. Height including drain connection

FLH 208 V

Technical data FlexLine Heater					
Unit type	FLH03		FLH06		FLH15
Steam output [lb/h]	5,5 - 5,5 - 7,3		10,8 - 10,8 - 14,3		26,9 - 26,9 - 36,6
Electrical connection ⁽¹⁾	208 - 208 - 240V /1Ph /N /50-60Hz	208 - 208 - 240V /3Ph /50-60Hz	208 - 208 - 240V /1Ph /N /50-60Hz	208 - 208 - 240V /3Ph /50-60Hz	
Rated power [kW]	1,8 - 1,8 - 2,4		3,7 - 3,7 - 4,9		9,3 - 9,3 - 12,4
Nominal current [A]	8,8 - 8,8 - 10,2		17,7 - 17,7 - 20,4		25,9 - 25,9 - 29,9
Fuse [A]	1 x 16	3 x 16	1 x 25	3 x 25	3 x 35
Connection terminals max. [in ²]	0,2				0,4
Number of steam cylinder	1				
Control	FlexLine mainboard with capacitive 3.5" touch colour display				
Control voltage ⁽³⁾	208 - 240V 2,5A				
Steam hose connection [in]	1 x 1,0				
Water consumption ⁽⁷⁾ [usgal/h]	3,96		7,8		19,92
Water flow rate ⁽⁸⁾ [usgal/min]	0,34 / 5,42				0,74 / 5,81
Max. filling capacity [usgal]	1,3				3,7
Empty weight [lb]	39,7				55,1
Operation weight [lb]	51,4				87,1
Width ⁽⁹⁾ [in]	21,3				
Height ⁽⁹⁾ [in]	21,1				27,4
Depth ⁽⁹⁾ [in]	12,6				
Water connection	fully demineralised water / cleaned condensate / partially softened tap water of varying qualities 1 to 10 bar, for 3/4" external thread				
Drain water connection	Connection Ø 1 1/4"				

FLH 460 V

Technical data FlexLine Heater					
Unit type	FLH06	FLH09	FLH15	FLH25	FLH30
Steam output [lb/h]	12,1 - 13,2 - 14,3	18,1 - 19,8 - 21,6	30,6 - 33,1 - 36,6	50,9 - 55,1 - 60,4	61,3 - 66,1 - 73,0
Electrical connection ⁽¹⁾	440 - 460 - 480V /3Ph /50-60Hz				
Rated power [kW]	4,1 - 4,5 - 4,9	6,2 - 6,8 - 7,3	10,4 - 11,4 - 12,4	17,3 - 18,9 - 20,6	20,9 - 22,8 - 24,8
Nominal current [A]	9,4 - 9,8 - 10,2	14 - 14,7 - 15,3	13,7 - 14,3 - 14,9	22,7 - 23,7 - 24,8	27,4 - 28,6 - 29,9
Fuse [A]	3 x 16			3 x 30	3 x 35
Connection terminals max. [in ²]	0,2		0,4		1,4
Number of steam cylinder	1				
Control	FlexLine mainboard with capacitive 3.5" touch colour display				
Control voltage ⁽³⁾	208 - 240V 0,5A				
Steam hose connection [in]	1 x 1,0			1 x 1,6	1 x 1,6 ⁽⁶⁾
Water consumption ⁽⁷⁾ [usgal/h]	7,8	11,76	19,92	32,88	39,72
Water flow rate ⁽⁸⁾ [usgal/min]	0,34 / 5,42		0,74 / 5,81		1,08 / 6,16
Max. filling capacity [usgal]	1,3		3,7		9,5
Empty weight [lb]	44,1		59,5		88,2
Operation weight [lb]	55,8		91,5		168,7
Width ⁽⁹⁾ [in]	21,3				25,2
Height ⁽⁹⁾ [in]	21,1		27,4		30,9
Depth ⁽⁹⁾ [in]	12,6				16,5
Water connection	fully demineralised water / cleaned condensate / partially softened tap water of varying qualities 1 to 10 bar, for 3/4" external thread				
Drain water connection	Connection Ø 1 1/4"				

⁽¹⁾ Other voltages on request ⁽³⁾ Separate control voltage on r ⁽⁶⁾ Including Y-piece DN40

⁽⁷⁾ Maximum water consumption at 100% demand plus blow down losses.
Water consumption depends on the water quality and options installed.

⁽⁸⁾ Flow rate of the feed water during refilling or pumping out. Unit without options / maximum rate with options.

⁽⁹⁾ Outer dimensions of width and depth. Height including drain connection

FLH 460 V

Technical data FlexLine Heater				
Unit type	FLH40	FLH50	FLH80	FLH100
Steam output [lb/h]	81,6 - 88,2 - 97,0	96,3 - 105,4 - 114,6	162,9 - 176,4 - 194,0	192,7 - 210,5 - 229,3
Electrical connection ⁽¹⁾	440 - 460 - 480V /3Ph /50-60Hz			
Rated power [kW]	27,7 - 30,3 - 33	32,8 - 35,8 - 39	2 X 27,7 - 30,3 - 33	2 X 32,8 - 35,8 - 39
Nominal current [A]	36,4 - 38 - 39,7	43 - 45 - 46,9	2 X 36,4 - 38 - 39,7	2 X 43 - 45 - 46,9
Fuse [A]	3 x 50		2 x 3 x 50	
Connection terminals max. [in ²]			1,4	
Number of steam cylinder	1		2	
Control	FlexLine mainboard with capacitive 3.5" touch colour display			
Control voltage ⁽³⁾	208 - 240V 0,5A		208 - 240V 1A	
Steam hose connection [in]	2 x 1,6		4 x 1,6	
Water consumption ⁽⁷⁾ [usgal/h]	52,8	62,4	105,6	124,8
Water flow rate ⁽⁸⁾ [usgal/min]	1,08 / 6,16		2 x 1,08 / 6,16	
Max. filling capacity [usgal]	9,5		18,9	
Empty weight [lb]	88,2		176,4	
Operation weight [lb]	168,7		334,9	
Width ⁽⁹⁾ [in]	25,2		46,1	
Height ⁽⁹⁾ [in]	30,9			
Depth ⁽⁹⁾ [in]	16,5			
Water connection	fully demineralised water / cleaned condensate / partially softened tap water of varying qualities 1 to 10 bar, for 3/4" external thread			
Drain water connection	2x Connection Ø 1 1/4"			

FLH 600 V

Technical data FlexLine Heater					
Unit type	FLH06	FLH09	FLH15	FLH25	FLH30
Steam output [lb/h]	10,1 - 11,0 - 11,0	15,0 - 16,3 - 16,3	25,4 - 27,8 - 27,8	42,1 - 45,9 - 45,9	50,8 - 55,2 - 55,2
Electrical connection ⁽¹⁾	575 - 600 - 600V /3Ph /50-60Hz				
Rated power [kW]	3,4 - 3,7 - 3,7	5,1 - 5,6 - 5,6	8,7 - 9,4 - 9,4	14,3 - 15,6 - 15,6	17,3 - 18,8 - 18,8
Nominal current [A]	5,9 - 6,2 - 6,2	8,9 - 9,3 - 9,3	8,7 - 9,1 - 9,1	14,4 - 15 - 15	17,4 - 18,1 - 18,1
Fuse [A]	3 x 16				3 x 20
Connection terminals max. [in ²]	0,2		0,4		1,4
Number of steam cylinder	1				
Control	FlexLine mainboard with capacitive 3.5" touch colour display				
Control voltage ⁽³⁾	208 - 240V 0,5A				
Steam hose connection [in]	1 x 1,0		1 x 1,6		1 x 1,6 ⁽⁶⁾
Water consumption ⁽⁷⁾ [usgal/h]	6	8,88	15,12	24,96	32,88
Water flow rate ⁽⁸⁾ [usgal/min]	0,34 / 5,42		0,74 / 5,81		1,08 / 6,16
Max. filling capacity [usgal]	1,3		3,7		9,5
Empty weight [lb]	44,1		59,5		88,2
Operation weight [lb]	55,8		91,5		168,7
Width ⁽⁹⁾ [in]	21,3				25,2
Height ⁽⁹⁾ [in]	21,1		27,4		30,9
Depth ⁽⁹⁾ [in]	12,6				16,5
Water connection	fully demineralised water / cleaned condensate / partially softened tap water of varying qualities 1 to 10 bar, for 3/4" external thread				
Drain water connection	Connection Ø 1 1/4"				

⁽¹⁾ Other voltages on request

⁽³⁾ Separate control voltage on request

⁽⁷⁾ Maximum water consumption at 100% demand plus blow down losses. Water consumption depends on the water quality and options installed.

⁽⁸⁾ Flow rate of the feed water during refilling or pumping out. Unit without options / maximum rate with options.

⁽⁹⁾ Outer dimensions of width and depth. Height including drain connection

FLH 600 V

Technical data FlexLine Heater				
Unit type	FLH40	FLH50	FLH80	FLH100
Steam output [lb/h]	67,7 - 73,6 - 73,6	84,4 - 91,9 - 91,9	135,1 - 147,3 - 147,3	168,7 - 183,6 - 183,6
Electrical connection ⁽¹⁾	575 - 600 - 600V /3Ph /50-60Hz			
Rated power [kW]	23 - 25 - 25	28,7 - 31,2 - 31,2	2 x 23 - 25 - 25	2 x 28,7 - 31,2 - 31,2
Nominal current [A]	23,1 - 24,1 - 24,1	29,7 - 30,1 - 31	2 x 23,1 - 24,1 - 24,1	2 x 29,7 - 30,1 - 31
Fuse [A]	3 x 30	3 x 35	2 x 3 x 30	2 x 3 x 35
Connection terminals max. [in ²]	1,4			
Number of steam cylinder	1		2	
Control	FlexLine mainboard with capacitive 3.5" touch colour display			
Control voltage ⁽³⁾	208 - 240V 0,5A		208 - 240V 1A	
Steam hose connection [in]	2 x 1,6		4 x 1,6	
Water consumption ⁽⁷⁾ [usgal/h]	40,08	50,04	80,16	99,96
Water flow rate ⁽⁸⁾ [usgal/min]	1,08 / 6,16		2 x / 1,08 / 6,16	
Max. filling capacity [usgal]	9,5		18,9	
Empty weight [lb]	88,2		176,4	
Operation weight [lb]	168,7		334,9	
Width ⁽⁹⁾ [in]	25,2		46,1	
Height ⁽⁹⁾ [in]	30,9			
Depth ⁽⁹⁾ [in]	16,5			
Water connection	fully demineralised water / cleaned condensate / partially softened tap water of varying qualities 1 to 10 bar, for 3/4" external thread			
Drain water connection	Connection Ø 1 1/4"		2x Connection Ø 1 1/4"	

FLP 208V

Technical specifications FlexLinePlus heater (FLPxx-T)		
Technical specifications FlexLinePlus Professional heater (FLPxx-TPRO)		
Unit type	FLP05	FLP15
Steam output [lb/h]	9,0 - 9,0 - 12,1	26,9 - 26,9 - 36,6
Electrical connection ⁽¹⁾	208 - 208 - 240V /3Ph /50-60Hz	
Rated power [kW]	3,1 - 3,1 - 4,1	9,3 - 9,3 - 12,4
Nominal current [A]	14,9 - 14,9 - 17,2	25,9 - 25,9 - 29,9
Fuse [A]	3 x 20	3 x 35
Connection terminals max. [in ²]	0,2	0,4
Number of steam cylinder	1	
Control	FlexLine mainboard with capacitive 3.5" touch colour display	
Control voltage ⁽³⁾	208 - 240V 2,5A	
Steam hose connection [in]	1 x 1,0 ⁽⁵⁾	
Water consumption ⁽⁷⁾ [usgal/h]	6,6	19,92
Water flow rate ⁽⁸⁾ [usgal/min]	0,74 / 5,81	
Max. filling capacity [usgal]	4,0	
Empty weight [lb]	70,5	75,0
Operation weight [lb]	104,7	109,1
Width ⁽⁹⁾ [in]	25,6	
Height ⁽⁹⁾ [in]	33,7	
Depth ⁽⁹⁾ [in]	15,0	
Water connection ⁽¹⁰⁾	fully demineralised water / cleaned condensate / partially softened tap water of varying qualities 1 to 10 bar, for 3/4" external thread	
Drain water connection	Connection Ø 1 1/4"	

⁽¹⁾ Other voltages on request

⁽³⁾ Separate control voltage on request

⁽⁵⁾ Including adapter DN40/DN25

⁽⁷⁾ Maximum water consumption at 100% demand plus blow down losses. Water consumption depends on the water quality and options installed.

⁽⁸⁾ Flow rate of the feed water during refilling or pumping out. Unit without options / maximum rate with options.

⁽⁹⁾ Outer dimensions of width and depth. Height including drain connection

⁽¹⁰⁾ FLP-TPRO devices may only be operated with softened water

FLP 460V

Technical specifications FlexLinePlus heater (FLPxx-T)							
Technical specifications FlexLinePlus Professional heater (FLPxx-TPRO)							
Unit type	FLP05	FLP08	FLP15	FLP25	FLP30	FLP40	FLP50
Steam output [lb/h]	10,1 - 11,0 - 12,1	17,0 - 17,6 - 20,1	30,6 - 33,1 - 36,6	50,9 - 55,1 - 60,4	61,3 - 66,1 - 73,0	81,6 - 88,2 - 97,0	96,3 - 105,4 - 114,6
Electrical connection ⁽¹⁾	440 - 460 - 480V /3Ph /50-60Hz						
Rated power [kW]	3,5 - 3,8 - 4,1	5,8 - 6,3 - 6,9	10,4 - 11,4 - 12,4	17,3 - 18,9 - 20,6	20,9 - 22,8 - 24,8	27,7 - 30,3 - 33	32,8 - 35,8 - 39
Nominal current [A]	7,9 - 8,3 - 8,6	13,1 - 13,7 - 14,3	13,7 - 14,3 - 14,9	22,7 - 23,7 - 24,8	27,4 - 28,6 - 29,9	36,4 - 38 - 39,7	43 - 45 - 46,9
Fuse [A]	3 x 16			3 x 30	3 x 35	3 x 50	
Connection terminals max. [in ²]	0,2		0,4		1,4		
Number of steam cylinder	1						
Control	FlexLine mainboard with capacitive 3.5" touch colour display						
Control voltage ⁽³⁾	208 - 240V 0,5A						
Steam hose connection [in]	1 x 1,0 ⁽⁵⁾			1 x 1,6	1 x 1,6 ⁽⁶⁾	2 x 1,6	
Water consumption ⁽⁷⁾ [usgal/h]	6,6	10,92	19,92	32,88	39,72	52,8	62,4
Water flow rate ⁽⁸⁾ [usgal/min]	0,74 / 5,81				1,08 / 6,16		
Max. filling capacity [usgal]	4,0				7,9		
Empty weight [lb]	70,5		77,2		90,4		
Operation weight [lb]	104,7		111,3		157,6		
Width ⁽⁹⁾ [in]	25,6						
Height ⁽⁹⁾ [in]	33,7						
Depth ⁽⁹⁾ [in]	15,0						
Water connection ⁽¹⁰⁾	fully demineralised water / cleaned condensate / partially softened tap water of varying qualities 1 to 10 bar, for 3/4" external thread						
Drain water connection	Connection Ø 1 1/4"						

FLP 600 V

Technical specifications FlexLinePlus heater (FLPxx-T)							
Technical specifications FlexLinePlus Professional heater (FLPxx-TPRO)							
Unit type	FLP05	FLP08	FLP15	FLP25	FLP30	FLP40	FLP50
Steam output [lb/h]	8,4 - 9,3 - 9,3	14,1 - 15,2 - 15,2	25,4 - 27,8 - 27,8	42,1 - 45,9 - 45,9	50,8 - 55,2 - 55,2	67,7 - 73,6 - 73,6	84,4 - 91,9 - 91,9
Electrical connection ⁽¹⁾	575 - 600 - 600V /3Ph /50-60Hz						
Rated power [kW]	2,9 - 3,1 - 3,1	4,8 - 5,2 - 5,2	8,7 - 9,4 - 9,4	14,3 - 15,6 - 15,6	17,3 - 18,8 - 18,8	23 - 25 - 25	28,7 - 31,2 - 31,2
Nominal current [A]	5 - 5,2 - 5,2	8,3 - 8,7 - 8,7	8,7 - 9,1 - 9,1	14,4 - 15 - 15	17,4 - 18,1 - 18,1	23,1 - 24,1 - 24,1	29,7 - 30,1 - 31
Fuse [A]	3 x 16			3 x 20		3 x 30	3 x 35
Connection terminals max. [in ²]	0,2		0,4		1,4		
Number of steam cylinder	1						
Control	FlexLine mainboard with capacitive 3.5" touch colour display						
Control voltage ⁽³⁾	208 - 240V 0,5A						
Steam hose connection [in]	1 x 1,0 ⁽⁵⁾			1 x 1,6	1 x 1,6 ⁽⁶⁾	2 x 1,6	
Water consumption ⁽⁷⁾ [usgal/h]	5,04	8,28	15,12	24,96	32,88	40,08	50,04
Water flow rate ⁽⁸⁾ [usgal/min]	0,74 / 5,81				1,08 / 6,16		
Max. filling capacity [usgal]	4,0				7,9		
Empty weight [lb]	70,5		77,2		90,4		
Operation weight [lb]	104,7		111,3		157,6		
Width ⁽⁹⁾ [in]	25,6						
Height ⁽⁹⁾ [in]	33,7						
Depth ⁽⁹⁾ [in]	15,0						
Water connection ⁽¹⁰⁾	fully demineralised water / cleaned condensate / partially softened tap water of varying qualities 1 to 10 bar, for external thread						
Drain water connection	Connection Ø 1 1/4"						

⁽¹⁾ Other voltages on request

⁽³⁾ Separate control voltage on request

⁽⁵⁾ Including adapter DN40/DN25

⁽⁶⁾ Incl. Y-piece DN40

⁽⁷⁾ Maximum water consumption at 100% demand plus blow down losses. Water consumption depends on the water quality and options installed.

⁽⁸⁾ Flow rate of the feed water during refilling or pumping out. Unit without options / maximum rate with options.

⁽⁹⁾ Outer dimensions of width and depth. Height including drain connection

⁽¹⁰⁾ FLP-TPRO devices may only be operated with softened water

HygroMATIK®

Lise-Meitner-Str.3 • D-24558 Henstedt-Ulzburg
Phone +49(0)4193/ 895-0 • Fax -33
eMail hy@hygromatik.de • www.hygromatik.com
member of **CAREL Group**

