

HygroMATIK®

Control Standard



Manual



CST.CSA
E-8881774

Certain computer programs contained in this product [or device] were developed by HygroMatik GmbH ("the Work(s)").

Copyright © HygroMatik GmbH [29.12.2022]

Control Standard CSA

All Rights reserved.

Current version of this manual to be found on: www.hygromatik.com

HygroMatik GmbH grants the legal user of this product [or device] the right to use the Work(s) solely within the scope of the legitimate operation of the product [or device]. No other right is granted under this licence. In particular and without prejudice to the generality of the foregoing, the Work(s) may not be used, sold, licensed, transferred, copied or reproduced in whole or in part or in any manner or form other than as expressly granted here without the prior written consent of HygroMatik GmbH.

Information in this manual is subject to change or alteration without prior notice.

 WARNING**Risk of electrical shock!**

Hazardous electrical voltage!

All electrical work to be performed by certified expert staff (electricians or expert personnel with equivalent training) only.

1. Introduction	4
1.1 Typographic Distinctions	4
1.2 Documentation	4
1.3 Symbols in Use	4
1.3.1 Specific Symbols related to Safety Instructions	4
1.3.2 General Symbols	4
2. Safety Instructions	6
2.1 Guidelines for Safe Operation	6
2.1.1 Scope	6
2.1.2 Unit control	6
2.1.3 Unit Operation	6
2.1.4 Mounting, dismantling, maintenance and repair of the unit	7
2.1.5 Electrical	7
3. Unit Control	8
3.1 General description	8
3.2 Connection of interlock (safety) system	9
3.3 Control signal	10
3.3.1 1-step operation	10
3.3.2 Operation with an active humidity sensor or external controller	10
3.3.3 Wiring for control signal and safety (interlock) system for multiple devices	10
3.3.4 Wiring Diagrams	11
3.3.5 Mainboard inputs and outputs	14
3.4 Control operation	15
3.4.1 Principal user guidance	15
3.4.2 Menu structure	15
3.4.3 Menu tree	16
3.5 The control panel	17
3.6 Navigation within a menu	18
3.7 Tabular representation of reading value list and provider level submenus	19
3.7.1 The reading value list	19
3.7.2 Provider level submenus and relating parameters	19
3.8 Exemplary variation of a parameter setting	22
3.9 Detailed description of the user level reading values and settings	23
3.10 Detailed parameter descriptions	27
4. Trouble shooting	33
4.1 Error handling	33
4.1.1 Table of possible faults and related error codes	33
4.2 Table of functional disruptions	39

1. Introduction

Dear Customer,

Thank you for choosing a HygroMatik steam humidifier.

HygroMatik steam humidifiers represent the latest in humidification technology.

In order to operate your HygroMatik steam humidifier safely, properly and efficiently, please read these operating instructions, which are supplemented by other operating instructions for the relevant basic unit.

Employ your steam humidifier only in sound condition and as directed. Consider potential hazards and safety issues and follow all the recommendations in these instructions.

If you have additional questions, please contact your expert dealer.

For all technical questions or spare parts orders, please be prepared to provide unit type and serial number (see name plate on the unit).

1.1 Typographic Distinctions

- Preceded by a bullet: general specifications
- » Preceded by an arrow: procedures for servicing or maintenance which should or must be performed in the indicated order
- ☑ Installation step which must be checked off.

italics Terms used with graphics or drawings

1.2 Documentation

Retention

Please retain these operating instructions in a secure, always accessible location. If the product is resold, turn the documentation over to the new operator. If the documentation is lost, please contact HygroMatik.

Versions in Other Languages

These operating instructions are available in several languages. If interested, please contact HygroMatik or your HygroMatik dealer.

1.3 Symbols in Use

1.3.1 Specific Symbols related to Safety Instructions

According to ANSI Z535.6 the following signal words are used within this document:

▲ DANGER

DANGER indicates a hazardous situation which, if not avoided, will result in death or serious injury.

▲ WARNING

WARNING indicates a hazardous situation which, if not avoided, could result in death or serious injury.

▲ CAUTION

CAUTION indicates a hazardous situation which, if not avoided, could result in minor or moderate injury.

NOTICE

NOTICE is used to address practices not related to physical injury.

1.3.2 General Symbols

Please note

This symbol is used whenever a situation requires special attention beyond the scope of safety instructions.

Intended Use

The control described is an integral part of a HygroMatik steam humidifier. Use for other applications is not permitted. All instructions on intended use, which are given in connection with the basic device, apply.

Proper usage also comprises the adherence to the conditions specified by HygroMatik for:

- installation
- dismantling
- reassembly
- commissioning
- operation
- maintenance
- disposal

Only qualified and authorised personnel may operate the unit. Persons transporting or working on the unit must have read and understood the corresponding parts of the Operation and Maintenance Instructions and especially the chapter 2. „Safety Notes“. Additionally, operating personnel must be informed of any possible dangers. You should place a copy of the Operation and Maintenance Instructions at the unit's operational location (or near the unit).

By construction, HygroMatik steam humidifiers are not qualified for exterior application.

▲ WARNING

Risk of scalding!

Steam with a temperature of up to 100 °C is produced.

Do not inhale steam directly!

2. Safety Instructions

These safety instructions are required by law. They promote workplace safety and accident prevention.

2.1 Guidelines for Safe Operation

2.1.1 Scope

Comply with the accident prevention regulation „DGUV Regulation 3“ to prevent injury to yourself and others. Beyond that, national regulations apply without restrictions. This way you can protect yourself and others from harm.

2.1.2 Unit control

Do not perform any work which compromises the safety of the unit. Obey all safety instructions and warnings present on the unit.

In case of a malfunction or electrical power disruption, switch off the unit immediately and prevent a restart. Repair malfunctions promptly.

⚠ WARNING

Restricted use.

IEC 60335-1 stipulates as follows:

This device may be used by children of eight years of age and above as well as by persons with reduced physical, sensory or mental capabilities or lack of experience and knowledge so long as they are supervised or have been instructed regarding the safe use of the device and understand the hazards that may result from it. Cleaning and user maintenance of the unit must not be undertaken by children without supervision.

The following applies to the HygroMatik installation kits:

Please note

Ensure that the system/machine in which the HygroMatik installation kit will be installed fully complies with the provisions of the directives (2006/42/EC) and the EMC directive 2014/30/EU and that all safety-relevant functions have been implemented in the control system.

2.1.3 Unit Operation

⚠ WARNING

Risk of scalding!

Uncontrolled hot steam escape in case of leaking or defective components possible. Switch off unit immediately.

⚠ WARNING

For Ministeam devices applies:

Risk of scalding!

No persons may be under the cloud of steam blowing out (at a distance of approx. 1 m/40 inch in the direction of blowing out and 0.5 m/20 inch on both sides of the device).

NOTICE

Risk of material damage!

- The unit may be damaged if switched on repeatedly following a malfunction without prior repair. Rectify defects immediately!
- The unit must not be operated on a DC power supply.
- The unit may only be used connected to a steam pipe that safely transports the steam (not valid for MiniSteam units).
- Regularly check that all safety and monitoring devices are functioning normally. Do not remove or disable safety devices.
- Steam operation is only allowed when the unit cover is closed.

NOTICE

Water leaks caused by defective connections or malfunctions are possible.

Water is constantly and automatically filled and drained in the humidifier. Connections and water-carrying components must be checked regularly for correct operation.

2.1.4 Mounting, dismantling, maintenance and repair of the unit

NOTICE

The HygroMatik steam humidifier is IP20 protected. Make sure that the unit is not object to dripping water in the mounting location.

Installing a humidifier in a room without water discharge requires safety devices to protect against water leakages.

- Use genuine spare parts only
- After any repair work, have qualified personnel check the safe operation of the unit
- Attaching or installing of **additional components** is permitted only with the **written consent** of the manufacturer

NOTICE

Do not install HygroMatik steam generators above electrical equipment such as fuse boxes, electrical appliances, etc. In the case of a leakage, leaking water can damage the underlying electrical equipment

2.1.5 Electrical

▲WARNING

Risk of electrical shock!

Hazardous electrical voltage!

Any work on the electrical system to be performed by certified expert staff (electricians or expert personnel with comparable training) only.

Steam operation may only be started when the unit cover is closed.

During maintenance or installation work, the device must be disconnected from the power supply and secured against being switched on again. The absence of voltage must be ensured by a measurement.

Leaks can cause leakage currents. Observe safety regulations on working with voltage parts (applies to electrode steam humidifies).

After electrical installation or repair work, test all safety mechanisms (such as grounding resistance).

NOTICE

Use only original fuses with the appropriate amperage rating.

Regularly check the unit's electrical equipment. Promptly repair any damage such as loose connections or burned wiring.

Responsibility for intrinsically safe installation of the HygroMatik steam humidifiers is incumbent on the installing specialist company.

3. Unit Control

3.1 General description

The standard controller can be used for both electrode steam humidifiers and heater type steam humidifiers.

Operation of the HygroMatik steam humidifier is under microprocessor control.

For steam humidifiers with unit housing, a control switch is located on the front panel of the unit featuring two positions besides the „Zero“-position for a switched-off device.

„Pos. I“ : The unit is switched on

„Pos. „II“ : Cylinder water is manually drained



Control switch

For controlling the unit a control panel featuring a 3-digit display and a number of icons plus 4 touch keys is integrated in the unit front panel. Controlling the unit by software using the modbus RTU protocol is also possible. On request, modbus documentation is available from your expert dealer.



Control panel

For control signal processing inputs are available whose properties may be defined by parameter settings. Activating of the intake solenoid valve, the blow-down pump and the main contactor is achieved through relays on the main PCB. Another relay serves for signalling purposes (factory setting is „collective fault“).

As an ordering option, for provision of 2 additional switching functions, a pair of top-head rail relays is available for the plugable connection to the mainboard.

With heater type steam humidifier, the power is controlled via a single-phase or two-phase solid state relay (for devices with higher power).

With electrode steam humidifier, the electrode current is switched directly via one or two main contactor(s) designed for the respective device power.

Mainboard

The entire control logic, including the relays for basic operation, is implemented on a compact printed circuit board which, in the case of steam humidifiers with device housings, is attached to the vertical partition wall between the housing chambers.

All connections on the PCB are distinctive in order to allow for easy exchange of the board in case of maintenance.

On the main PCB, two vertically mounted fuse holders with bayonet fitting incorporate 1.6 A fast-blow fine wire fuses (F1 and F2 for L and N, s. section „Basis PCB connections“ in this chapter).

Safety systems

Besides the common external safety interlock (implemented by means of a switching contact or a through a building control system), the following safety is incorporated in the unit:

An electric heater type steam humidifier is thermally controlled at two spots minimum. Besides the thermo switch located on top of the steam cylinder and meant for overheating avoidance of the electrical heater element,

the solid state relay also is equipped with a thermo switch (higher output units feature 2 thermo switches in the cylinder cover). In case of one of the thermo switches being triggered, the main contactor is deenergized. The thermo switches on the steam cylinders may be reset mechanically after cool-down. The thermo switch attached to the solid state relay heatsink, however, is a bi-metal device. As such, it is released automatically after cool-down.

An other safety measure is the steam cylinder minimum water level control. For heater element protection and thermal overload risk avoidance, no heater element drive enabling is issued in case of minimum water level underrun.

Intrinsic safety

HygroMatik steam humidifiers comply with intrinsic safety requirements in that the electrical power supply may be cut by two devices.

In case of the electric heater type steam humidifier, these devices are the main contactor and the solid state relay.

In addition to the main contactor, an electrode steam humidifier is also equipped with a circuit breaker.

Please note

For electrical connection of the steam humidifier a residual current circuit breaker is recommended.

3.2 Connection of interlock (safety) system

▲WARNING

Risk of electrical shock!

Hazardous electrical voltage!

When standard wiring was made, terminal 1 shows 230 VAC after commissioning.

Across terminal 1 and 2 the so-called safety interlock is wired. This wiring allows for integration of safety devices. In case of an open safety interlock the steam humidifier does not operate.

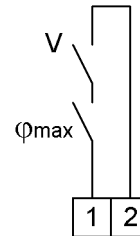

Safety interlock terminals 1/2

Please note

Factory setting leaves the safety interlock open!

Install contact interlocks, e.g. a max. hygostat, vane relays, pressure controllers, air interlock devices etc. in series across terminal 1 and 2.

NOTICE

Contacts across terminals 1 and 2 must be potential free and properly rated!

Rating must comply with the control voltage in use.

Best practice implies the integration of a max. hygostat in the safety interlock wiring to protect against over-humidification due to a r.h. sensor malfunction.

3.3 Control signal

As described in the „Unit Control“ chapter, section „Provider level submenu and its parameters“, the unit control type is determined by parameter „1-2“, „control signal“. In accordance with the control type selected, terminal wiring of the connection terminal (s. „Unit control“ chapter, section „Mainboard connections“ is to be made.

3.3.1 1-step operation

Steam humidifier operation is controlled by the contact across terminals 3 and 5 provided by the customer. This contact needs only to be low voltage proof.

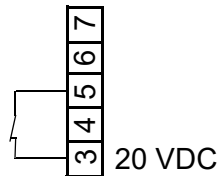

Customer-provided contact for 1-step operation

3.3.2 Operation with an active humidity sensor or external controller

When driving the steam humidifier by an active r.h. sensor or external controller (e.g. a PLC), control signals in the range of 0...10 V, 0...20 mA or 0...140 Ohm may be applied. Each one of the signal types is connected to a dedicated terminal (see „Unit control“ chapter, section „Mainboard connections“). Reference is always to terminal 4, GND.

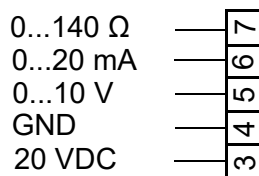

Terminals for control signals

Please note

Active r.h. sensors need an external supply voltage. For that purpose, terminal 3 has a +20 VDC offering.

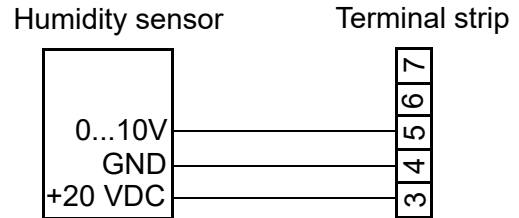

Exemplary 0...10V humidity sensor connection

3.3.3 Wiring for control signal and safety (interlock) system for multiple devices

In the case of multiple units, separate humidifiers work together. The control signal and the safety (interlock) system are connected to the master unit as described above. In addition, connecting cables are established between the guiding unit and the succeeding unit(s) (provided on-site). These provide the succeeding unit with a control signal from the guiding unit and the transmitted (potential free) safety (interlock) system.

The wiring for the control signal and the safety (interlock) system must be implemented as follows for multiple units:

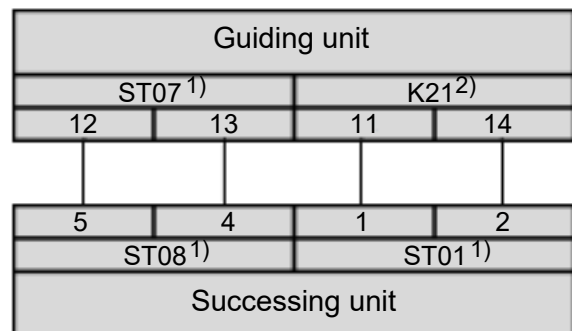

1) „ST0x“ designates connector plugs on the mainboard

2) „K21“ is the relay used for the connection of the succeeding unit

3.3.4 Wiring Diagrams

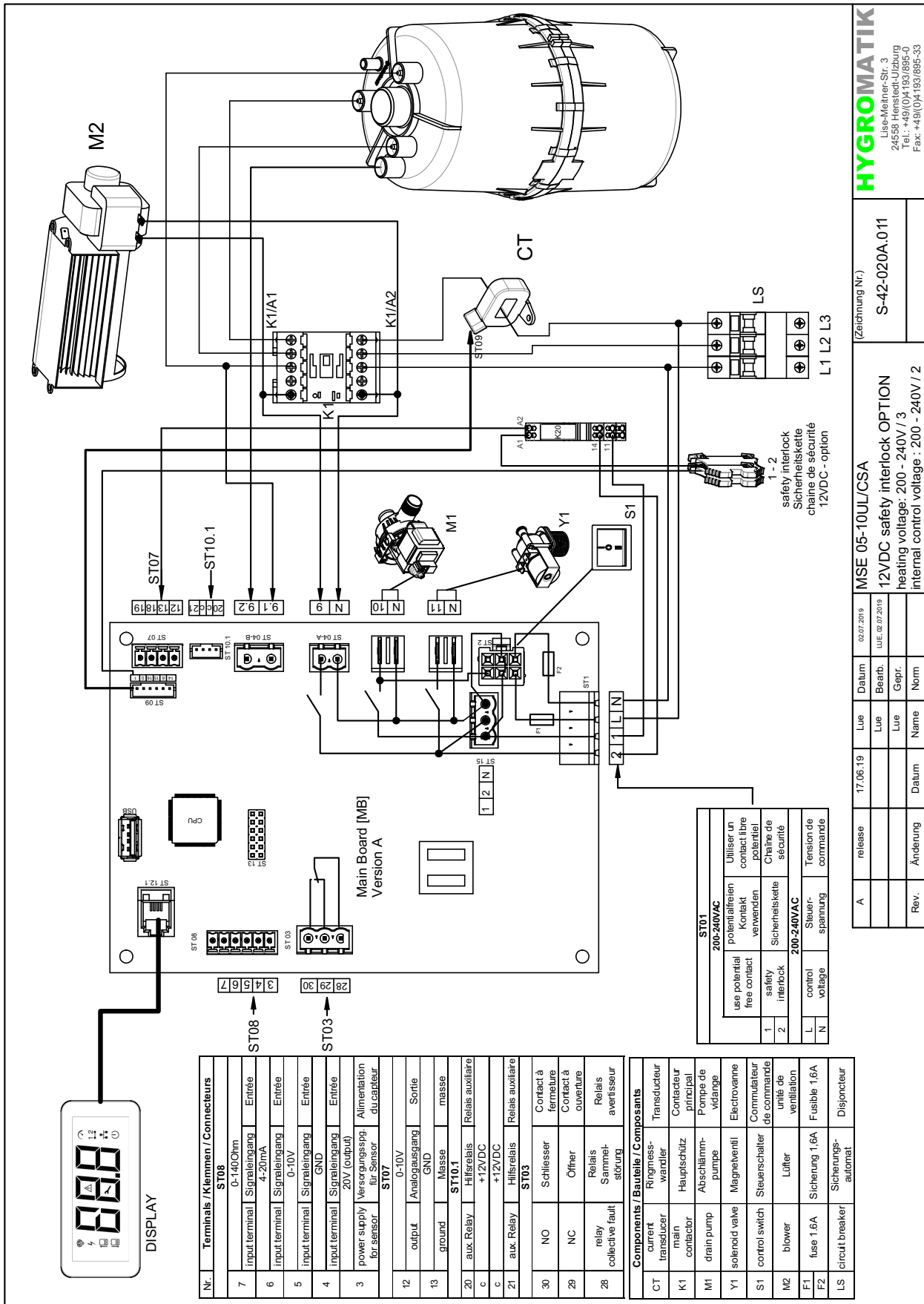

Nr.	Terminals / Klemmen / Connecteurs
ST08	
7	0-140Ohm Signalleingang Entrée
6	4-20mA Signalleingang Entrée
5	0-10V Signalleingang Entrée
4	GND Signalleingang Entrée
3	20V (output) Signalleingang Entrée
Alimentation pour le capteur	
ST07	
12	0-10V output Analogausgang Sortie
13	GND Masse
ST10.1	
20	auxiliary relays Hilfsrelais
c	+12VDC
c	+12VDC
21	auxiliary relays Hilfsrelais
ST03	
30	NO Schliesser Contact à fermeture
29	NC Öffner Contact à ouverture
28	relay collective fault Relais Sammelstörung Relais avertisseur

Components / Bauteile / Composants	Description
CT	current transducer Ringmesswandler Transducteur
K1	main contactor Hauptschutz Contactor principal
M1	drain pump Abschlämmpumpe Pompe de vidange
Y1	solenoid valve Magnetventil Electrovanne
S1	control switch Steuerschalter Commutateur de commande
M2	blower Lüfter unité de ventilation
F1	fuse 1.6A Sicherung 1,6A Fusible 1,6A
F2	fuse 1.6A Sicherung 1,6A Fusible 1,6A
LS	circuit breaker Sicherungsautomat Disjoncteur

ST01	
200-240VAC	use potential free contact potentiellfreien Kontakt verwenden
200-240VAC	safety interlock Sicherheitskette
200-240VAC	control voltage Steuer-spannung

HYGROMATIK
 Lise-Meitner-Str. 3
 24556 Henstedt-Ujzburg
 Tel.: +49(0)4193/895-0
 Fax: +49(0)4193/895-33

(Zeichnung Nr.)
S-42-020A.011

MSE 05-10U/L/CSA
12VDC safety interlock OPTION
 heating voltage: 200 - 240V / 3
 internal control voltage: 200 - 240V / 2

Rev.	Änderung	Datum	Name	Norm
A	release	17.06.19	Lue	
		02.07.2019	Lue	
		02.07.2019	Lue	
			Lue	

Rev.	Änderung	Datum	Name	Norm
			Lue	
			Lue	
			Lue	
			Lue	

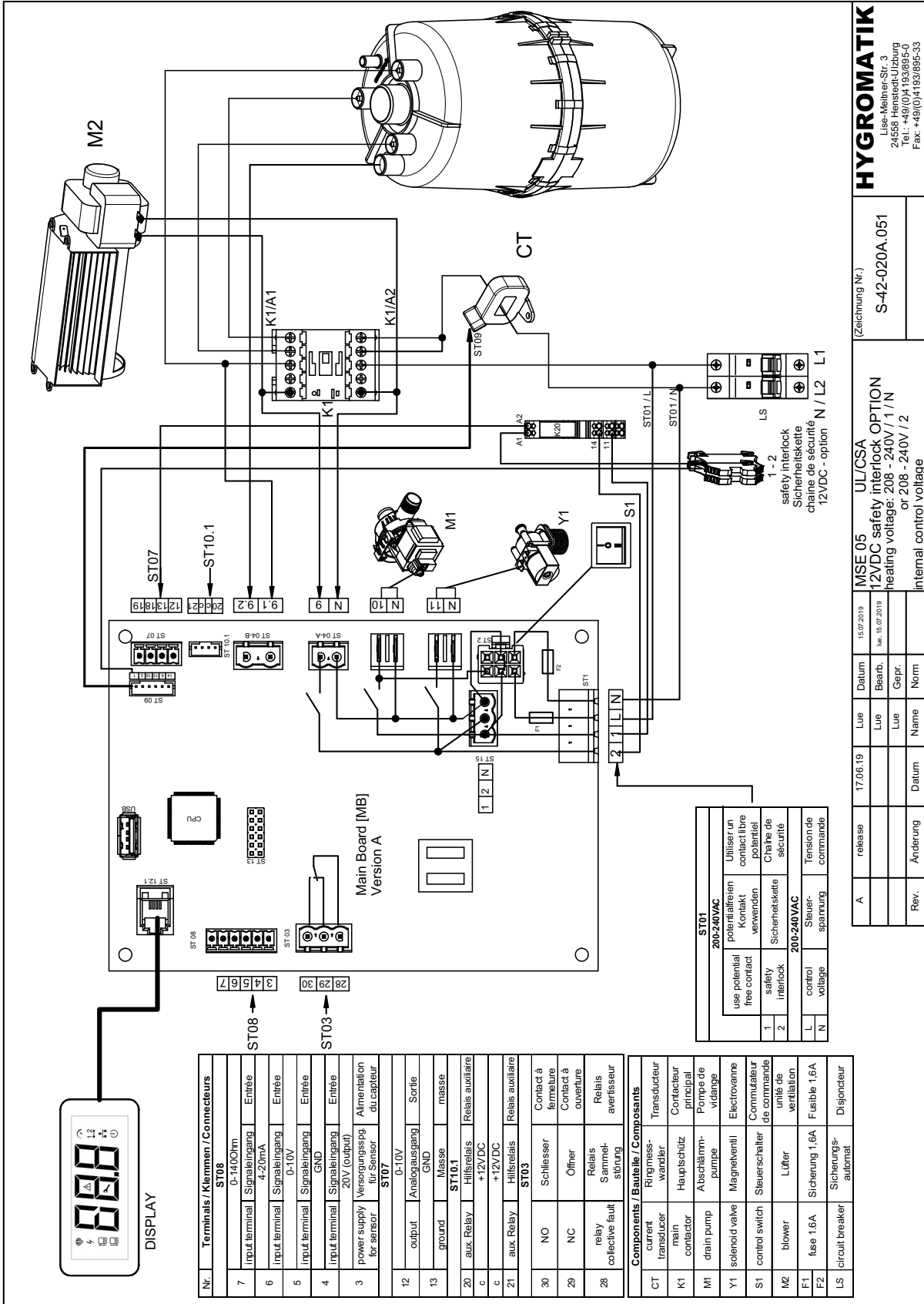

Nr.	Terminals / Klemmen / Connecteurs
ST08	
7	Input terminal Signaleingang Entrée
6	Input terminal Signaleingang Entrée
5	Input terminal Signaleingang Entrée
4	Input terminal Signaleingang Entrée
3	power supply Versorgungsspannung Alimentation pour le capteur
ST07	
12	output Analogausgang Sortie
13	ground Masse masse
ST10.1	
20	aux. Relay Hilfsrelais Relais auxiliaire
c.	+12VDC
c.	+12VDC
ST03	
21	aux. Relay Hilfsrelais Relais auxiliaire
30	NO Schliesser Contact à fermeture
29	NC Öffner Contact à ouverture
28	relay collective fault Relais Sammelstörung Relais avertisseur
Components / Bauteile / Composants	
CT	Ringmess- transducer wandler Transducteur
K1	main contactor Hauptschütz Contacteur principal
M1	drain pump Abschlämmpumpe Pompe de vidange
Y1	solenoid valve Magnetventil Electrovanne
S1	control switch Steuerschalter Commutateur de commande
M2	blower Lüfter unité de ventilation
F1	fuse 1.6A Sicherung 1,6A Fusible 1,6A
LS	circuit breaker Sicherungsautomat Disjoncteur

ST01	
200-240VAC	Utiliser un contact libre potentiel
use potential free contact	potentiel
1	Sicherheitskette
2	Chaîne de sécurité
200-240VAC	
L	Steuer- spannung
N	Tension de commande

A	release	17.06.19	Lue	Datum	15.07.2019	MSE 05	UL/CSA	HYGROMATIK Lise-Meiner-Str. 3 24558 Henstedt-Liżburg Tel.: +49(0)4 93895-0 Fax: +49(0)4193/895-33
						UL/CSA		
						12VDC safety interlock OPTION	S-42-020A.051	(Zeichnung Nr.)
						heating voltage: 208 - 240V / 1 / N		
						or 208 - 240V / 2		
						internal control voltage		
Rev.	Änderung	Datum	Name	Gepr.	Bearb.	15.07.2019		

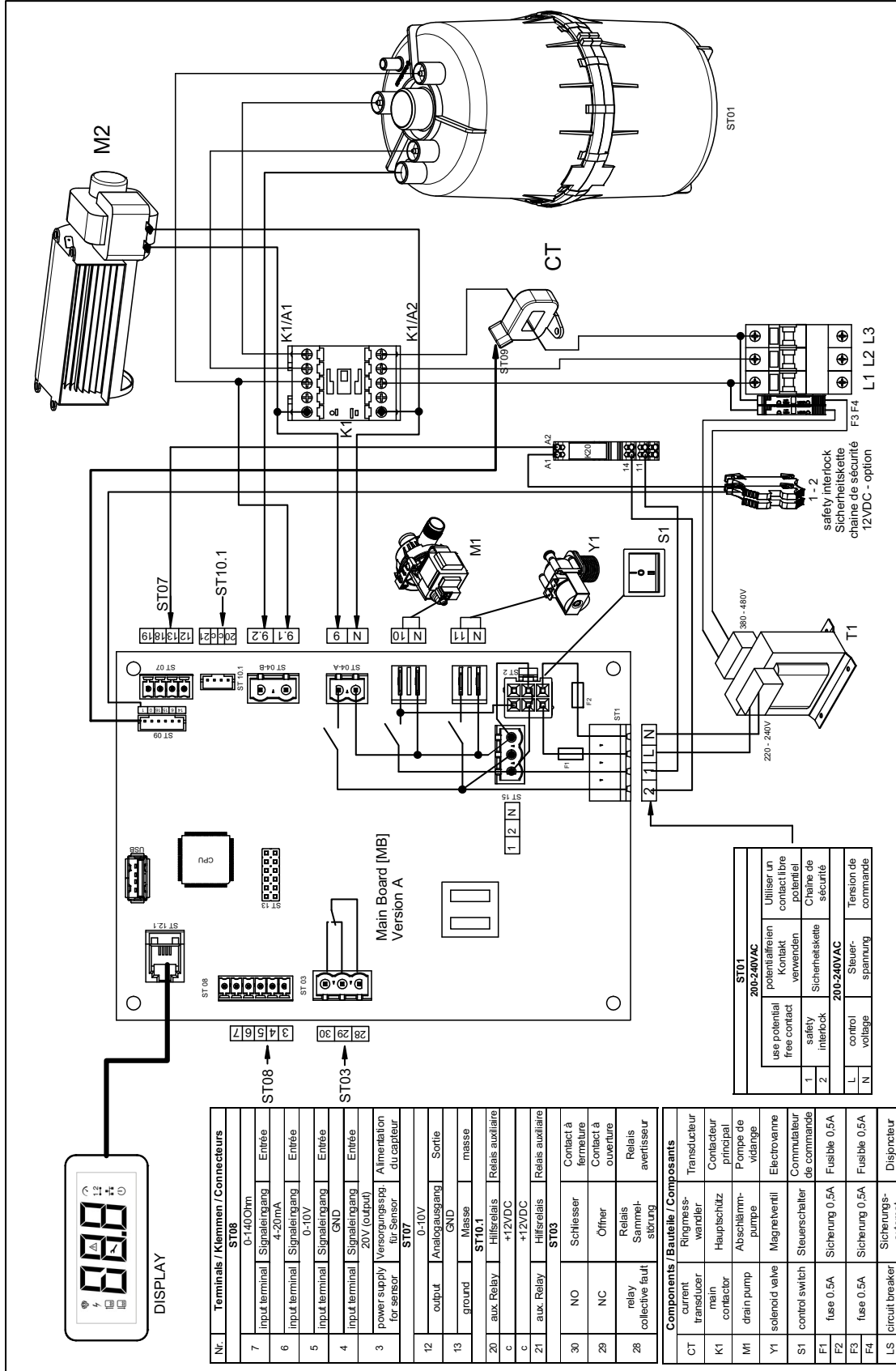

Nr.	Terminals / Klemmen / Connecteurs
ST08	
7	input terminal Signaleingang Entrée 0-140Ohm
6	input terminal Signaleingang Entrée 4-20mA
5	input terminal Signaleingang Entrée 0-10V
4	input terminal Signaleingang Entrée GND
3	power supply Versorgungsppg. Alimentation 20V (output) für Sensor für capteur
ST07	
12	output Analogausgang Sortie 0-10V
13	ground Masse masse GND
ST10.1	
20	aux. Relay Hilfsrelais Relais auxiliaire +12VDC
c	+12VDC
21	aux. Relay Hilfsrelais Relais auxiliaire GND
30	NO Schliesser Contact à fermeture
29	NC Öffner Contact à ouverture
28	relay collective fault Relais Sammel- störung Relais avertisseur

Components / Bauteile / Composants	Function / Beschreibung / Fonction
CT	current transducer Ringmesswandler Transducteur
K1	main contactor Hauptschutz Contacteur principal
M1	drain pump Abschlämpumpe Pompe de vidange
Y1	solenoid valve Magnetventil Electrovalve
S1	control switch Steuerschalter Commutateur de commande
F1	fuse 0.5A Sicherung 0,5A Fusible 0,5A
F2	fuse 0.5A Sicherung 0,5A Fusible 0,5A
F3	fuse 0.5A Sicherung 0,5A Fusible 0,5A
F4	fuse 0.5A Sicherung 0,5A Fusible 0,5A
LS	circuit breaker Sicherungsautomat Disjoncteur
T1	transformer Transformator transformateur

ST01	200-240VAC	380-480V
1	use potential free contact	Utiliser un contact libre potentiel
2	safety interlock	Sicherungskette
L	control voltage	Tension de commande
N		

HYGROMATIK
 Lisa-Meiner-Str. 3
 24958 Wismar-Gröden
 Tel.: +49(0)4193895-33
 Fax: +49(0)4193895-33

MSE 05-10 UL/CSA
 12VDC safety interlock OPTION
 heating voltage: 380 - 480V / 3
 control voltage: 220 - 240V / transformer

(Zeichnung Nr.): S-42-020A.071

Rev.	Änderung	Datum	Name	Norm
A	release	17.06.19	Lue	
			Lue	
			Lue	
			Lue	

15.07.2019
 15.07.2019

3.3.5 Mainboard inputs and outputs

Customer side interfaces

Inputs

ST08:

Possible external controller signals	
0(2) - 5 V DC	min. 0,1 mA**
0(2) - 10 V DC	min. 0,2 mA**
0(4) - 20 V DC	min. 0,3 mA**
0(4) - 20 mA DC	min. 3 V**
0 - 140 Ohm*	

* only for operating mode external controller

** minimum power of the control signal

Outputs

ST03:

- Potential-free programmable NC and NO contacts, (factory assignment is „collective fault“)

ST10.1:

- Connection option für 2 additional relays of the top head type (K20, K21) (ordering option).

ST07:

Control signal 0...10 VDC (max. 8 mA)

ST08:

- +20 VDC humidity sensor supply voltage (max. 20 mA)

ST15:

- Tap for 1,2 and N (unsecured) for customer use

USB:

Connection for USB stick for use as a data logger and for parameter updates

Power supply and safety interlock

ST01:

- 4-pin plug connection with screw terminal adaptor for L and N power connection and safety interlock („Terminals 1/2“)

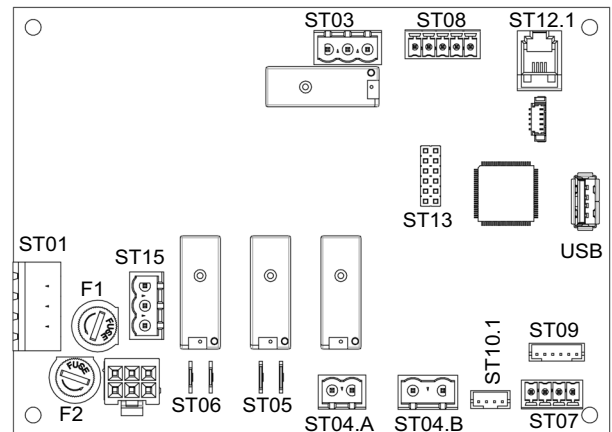

Inputs

ST09 (only for heater steam humidifiers):

- Filling level sensor

ST09 (only for electrode steam humidifiers):

- Current transducer connection

ST04-B (only for heater steam humidifiers):

- Galvanically isolated thermo switch input (via optical coupler)
- Dielectric strength 600 VAC

ST04-B (only for electrode steam humidifiers):

- Galvanically isolated sensor electrode input (via optical coupler)
- Dielectric strength 600 VAC

Outputs

ST04-A:

- Main contactor(s)

ST05:

- Blow-down pump

ST06:

- Inlet solenoid valve

ST07 (only for heater steam humidifiers):

- Solid state relay control signal (PWM), 20 mA max.

Bidirectional

ST12.1:

- Control panel serial interface

ST 13:

- RS485 interface adapter PCB socket

3.4 Control operation

3.4.1 Principal user guidance

On powering up the steam humidifier, the software version is shown in the display for a few seconds. In normal operation the display then shows actual steam output as a standard display. When a key is pressed the first reading in a list of reading and input values is output. The complete list may be visualized by scrolling using the arrow keys. Control-wise, the unit is in „user level“ (see next section).

By means of inputting a 2-digit code, access to „Provider level“ is possible (for input code, see table in section „Provider level submenus and relating parameters“). The provider level parameters are functionally grouped in submenus (1) to (6). The code input is reset to its standard („000“), should no keystroke occur within 3 minutes.

3.4.2 Menu structure

Overview on menu structure

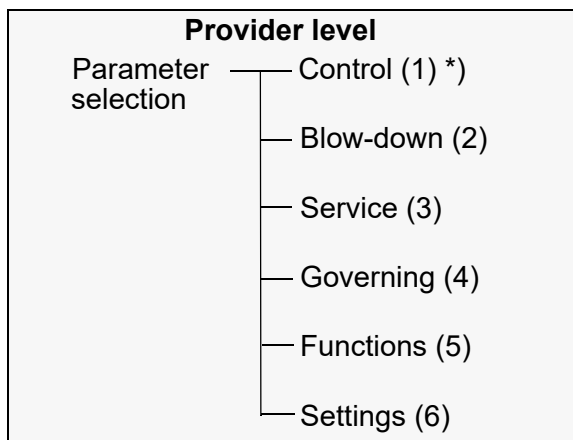
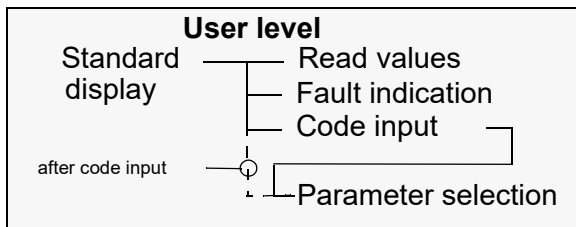

*) numbers in parenthesis are group numbers

User level

From standard display (actual steam output), user level may be accessed by pressing any key on the control panel. On user level, among other information, reading values r01 to r15 are available. After a certain time span with no keystroke, control switches the display back to standard display. Factory setting for this timeout is „10 minutes“.

Besides showing the reading values, user level also features „P00“ for code input allowing provider level access (s. „Menu tree section“).

Provider level

On provider level, the control parameters of functional groups (1) to (6) (s. „Overview on menu structure“) may be individually changed. A tabular list of the provider level parameters and a more detailed description may be found in the sections „Provider level submenus and their parameters“ and „Detailed parameter descriptions“, respectively, further down in this chapter.

Menu tree

The detailed menu tree with all of the reading values and settable values as well as all of the parameters is depicted in the next section.

3.4.3 Menu tree

User level

Provider level⁴⁾

r01 Status
r02 Error
r03 Act. steam output [kg/h] ¹⁾
r04 Act. steam output [lb/h] ²⁾
r05 Actual current [A] ⁶⁾
r06 Filling level [mm] ⁷⁾
r07 Internal demand [%]
r08 External demand [%]
r09 Power limitation [%]
r10 Set point r.h. [%] ³⁾
r11 R.h. actual value [%] ³⁾
r12 External signal [%]
r13 V-Signal
r14 mA-Signal
r15 Ω-Signal



P00 Code level (2 digits)

→ SET
← ESC

PAr Parameter selection⁴⁾

5)

- 1) only when SI system was selected
- 2) only when imperial system was selected
- 3) only when „PI controller“ was selected
- 4) only shown after code „10“ input
- 5) direct access when on provider level
- 6) only for electrode steam humidifiers
- 7) only for heater steam humidifiers

Λ V designates scrolling with control panel keys

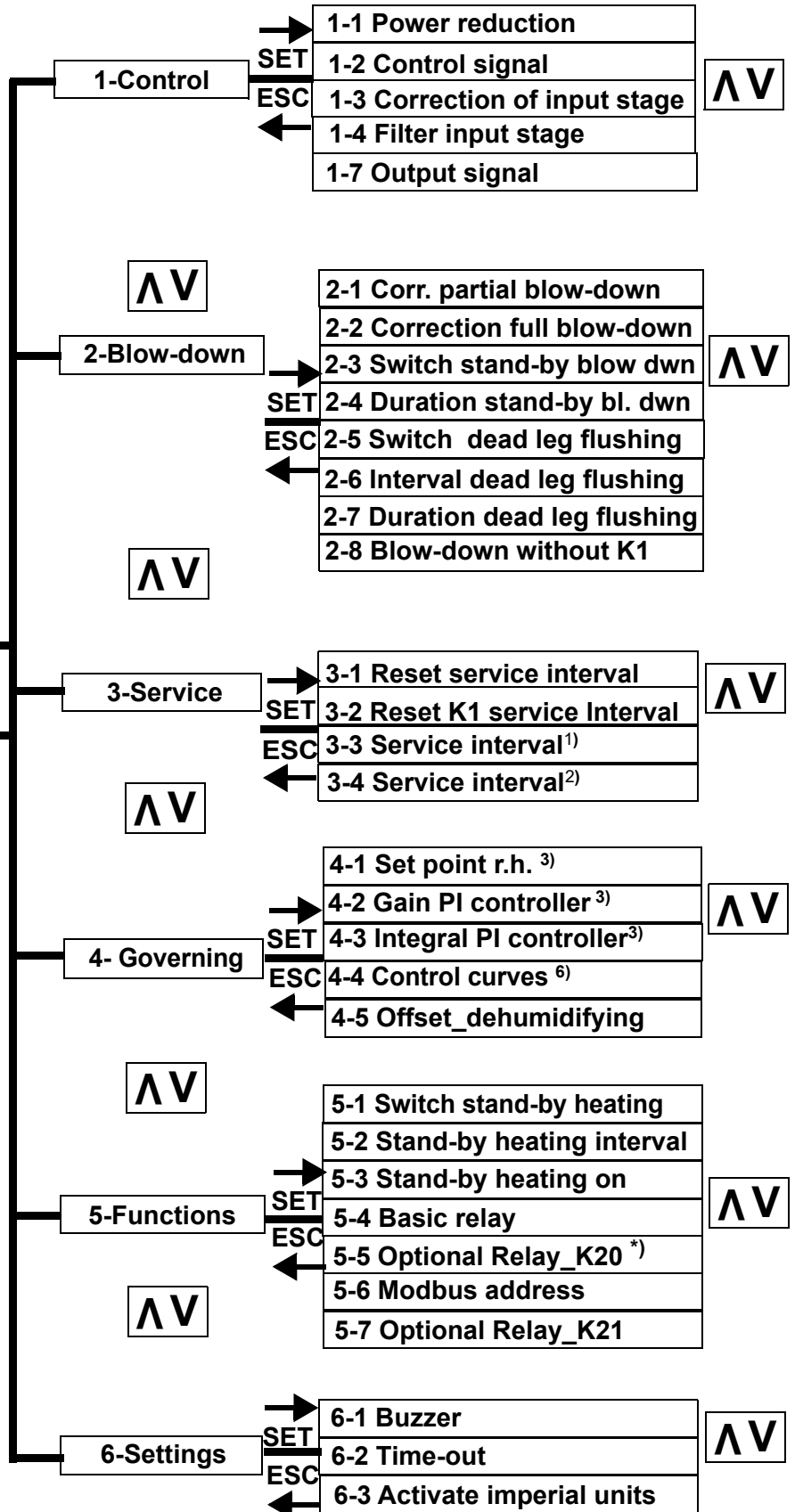

3.5 The control panel

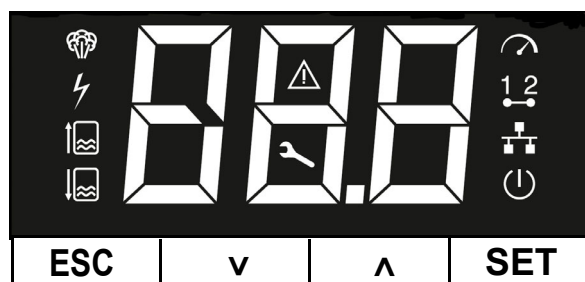

The control panel comprises 3 sections:

- the ESC, SET, **^**, **v** control keys
- the 3-digit 7-segment display
- dedicated icons for operating status indication

Please note

A flashing icon always indicates a faulty situation!

Exception: When switching the unit on, the complete display flashes 4 times. Then, the power-on-LED blinks while the device self test is run.

The **control keys** enable navigation in the menus and submenus. Their function is as follows:

„ESC“: cancellation or return to previous level

„**^**/**v**“ : move up/down within a menu, submenu or selection list.

„SET“: accept and store a selected setting.

The 3-digit **7-segment-display** serves for outputting of operational and input data as well as error code presentation. When control software expects an input the digits are blinked. Display semantics are determined by lightening-up of one or more icons related to a specific operational situation or device control environment.

Icons state table

	permanently lit	flashing
	Steam production active	Cylinder full <u>In conjunction with error icon:</u> Fault steam production
	Main contactor active	Fault main contactor
	Filling active	Fault filling
	Blow-down active	Fault blow-down
	(State not possible)	Error s. error codes
	Maintenance required	(State not possible)
	Demand	Fault control signal
	Safety interlock closed	(State not possible)
	Virtual safety interlock closed by software enabling	(State not possible)
	Control active	Control self test after unit start

3.6 Navigation within a menu

User level entry

Standard display during normal operation is actual steam output in the selected dimension ([kg/h] or [lbs/h], respectively). By pressing any key, user level comprising a reading value index (pointer) selection level and the reading values as such is entered.

„r01“ is displayed indexing the first reading value.

Reading value display

By scrolling using the „▲/▼“ keys, the reading value indexes „r01“ to „r15“ , code entry „P00“ (s. below) and parameter selection „PAr“*) may be addressed. The actual reading value content is output on pressing the SET key after selection of one of the reading value pointers r01 to r15.

Use the ESC key for return to the reading value index level that allows for addressing further reading values.

„P00“ allows for inputting a code for provider level entry that supports changing of the parameters (s. next section). This function is not meant for usage by the steam humidifier user.

*) „PAr“ ist only presented when a „10“ was input as the „P00“ setting value for access to provider level. When „PAr“ is confirmed with the SET key, parameter group selection is supported without the need for inputting the access code again.

Provider level code entry and setting a parameter

- » Using the „▲/▼“ keys, scroll until „P00“ is displayed and confirm with the SET key. „00“ is displayed.
- » Increase the display to „10“ using the „▲/▼“ keys and confirm with the SET key („10“ is the access code for the provider level). „1- “ is now displayed for selection of one of the parameter groups (1) to (6).
- » Confirm parameter group (1) with the SET key or make an other selection with the „▲/▼“ keys and then confirm. The display will now show a „1“ in the right digit position for addressing the parameter index (e.g., „2-1“).
- » Confirm selection with the SET key or vary selection with the „▲/▼“ keys and then confirm.

Use the ESC key for return to the previous input level.

3.7 Tabular representation of reading value list and provider level submenus

For a detailed description, pls. refer to the respective sections within this chapter.

3.7.1 The reading value list

From normal operation, the user may access the reading value index „r01“ (Status) by pressing any key.

By scrolling using the „**▲/▼**“ keys the reading and setting values indicated in the table below may be addressed. To output the value content, the SET key must be pressed first.

Detailed parameter descriptions may be found in the section „Detailed parameter description“ further down in this chapter. The „Setting options“ column indicates the presettings available or the range of values to be chosen from. „Fs“ stands for „Factory setting“.

Reading value index	Description
r01	Status
r02	Fault
r04	Actual steam output [lb/h]
r05	Actual current [A] (only for electrode steam humidifiers)
r06	Filling level [mm] (only for heater steam humidifiers)
r07	Internal demand [%]
r08	External demand [%]
r09	Power limitation [%]
r10	Set value r.h. [%] (only when PI controller was selected)
r11	Actual value r.h. [%] (only when PI controller was selected)
r12	External signal [%]
r13	V-Signal
r14	mA-Signal
r15	Ω-Signal
r16	Service_Status
P00	Code level („0“, „10“)
PAr	Parameter group selection

3.7.2 Provider level submenus and relating parameters

Submenu „Control“ (Group1

Par.	Denomination	Setting options	Code
1-1	Steam output max. [%]	25 ... 100 Fs*) = 100	10
1-2	Control signal	0= not valid 1= ext. controller, 0 ... 10 V 2= ext. controller, 0 ... 20 mA 3= ext. controller, 0..140 Ω 4= PI controller, 0 ... 10 V 5= PI controller, 4 ... 20 mA 6= PI controller, 0 ...140 Ω 7= 1-step 8= Modbus Fs = 1	10
1-3	Correction input stages [%]	-5.0 ... +5.0 Fs = 0	10
1-4	Filter input stage	0=light, 1=strong Fs = 0	
1-7	Output signal	0= Off 1= Actuator signal_extern 2= Actuator signal_intern 3= Humidity actual value	

*) Fs = Factory setting

Submenu „Blow-down“ (Group 2)

Par.	Denomination	Setting options	Code
2-1	Correction partial blow-down	-5...+5 Fs = 0	10
2-2	Correction full blow-down	-5...+5 Fs = 0	10
2-3	Switch stand-by blow-down	0=off, 1=on Fs = 1	10
2-4	Waiting time stand-by blow-down [h]	0.1...48.0 Fs = 24.0	10
2-5	Switch dead leg flushing	0=off, 1=on Fs = 0	10
2-6	Interval dead leg flushing [h]	0.1...96.0 Fs = 24.0	10
2-7	Duration deadleg flushing [s]	1...600 Fs = 90	10
2-8	Blow-down without K1 (only for electrode steam humidifiers)	0=no, 1=yes Fs = 0	10
2-9	Steam-down time (only for heater steam humidifiers)	0...250 WV=240	10

Submenu „Service“ (Group 3)

Par.	Denomination	Setting options	Code
3-1	Reset service interval steam amount	0=no, 1=yes Fs = 0	10
3-2	Reset K1 service interval	0=no, 1=yes Fs = 0	10
3-4	Service interval [tn. sh.]	0 ...90.0 Fs = device dependant	10

Submenu „Governing“ (Group 4)

Par.	Denomination	Setting options	Code
4-1	Set point r.h. [%] (PI controller only)	5...99.9 Fs = 50.0	10
4-2	Gain [%] (PI controller only)	0.1...99.9 Fs = 5.0	10
4-3	Integral [%] (PI controller only)	0...100.0 Fs = 10	10
4-4	Control curve (only for electrode steam humidifiers)	0 = energy optimisation 1 = load optimisation Fs = 1	10
4-5	Offset_dehumidifying	Hysteresis for dehumidifying [%] Fs=10	10

Submenu „Functions“ (Group 5)

Par.	Denomination	Setting options	Code
5-1	Switch stand-by heating	0=off, 1=on Fs = 0	10
5-2	Interval stand-by heating [min]	1...999 Fs = device dependant	10
5-3	Stand-by heating [s]	1...999 Fs = device dependant	10
5-4	Basic relay	0 = collective fault 1 = stand-by 2 = no demand 3 = humidifying 5 = remote off 30 = filling off 31 = filling on 37 = HyCool 60 = Blow-down off 61 = Blow-down on 62 = Partial blow-down 63 = Full blow-down 66 = max. level 67 = Stand-by blow-down 68 = Dead leg flushing 69 = Start-up blow-down 270 = Collectice Service Fs = 0	
5-5	Relay_K20	same as for basic relay Fs = 270	10
5-6	Modbus address	0..255 Fs = 1	10
5-7	Relay_K21	same as for basic relay Fs = 270	

Submenu „Settings“ (Group 6)

Par.	Denomination	Setting options	Code
6-1	Buzzer	0=off, 1=on Fs = 0	10
6-2	Time-Out (return to standard display) [min]	0 ... 60 Fs = 2	10
6-3	Activate imperial units	0 = SI units 1 = imperial units Fs = 0	10

3.8 Exemplary variation of a parameter setting

Example: Control signal is to be changed from „Ext. controller, 0 ...10V“ („1-2“ = „1“) to „PI controller, 0 ...10V“ („1-2“ = „4“).

Please note

The steps below make an essential change to a control parameter. If this is not intended, be sure to reestablish the original setting after changing it for exercising purposes.

- » In normal operation, press any key to access the reading value list. „r01“ is displayed.
- » Scroll from „r01“ to „P00“ (Code input).
- » Press SET key. Display now shows a flashing „Zero“ for code level „0“ (user level) and input readiness.
- » Using the „▲/▼“ keys, change the display to „10“.
- » Press the SET key. Provider level is now entered. „1-“ is displayed as the first parameter group to be changed.
- » Since the parameter to be changed is in this group already, group confirmation can be made immediately with the SET key.
- » Scroll with the „▲/▼“ keys to the „1-2“ position and confirm with the SET key. The parameter setting „1“ (external controller, 0...10 V) is displayed and may be changed.
- » Change the setting to „4“ (PI controller, 0...10 V) with the „▲/▼“ keys and confirm with the SET key.
- » Pressing the ESC key twice brings the display back to standard display (i.e. actual steam output).

These steps are exemplary. In the same way, selection and variation of all of the other parameters may be accomplished.

3.9 Detailed description of the user level reading values and settings

Reading value		Explanation	
r01 Status	Code	Denomination	Description
Main functions category	00	Start	Humidifier is in startup phase after a cold start. The Power-ON-LED flashes.
	01	Stand-by	Safety interlock is open (safety interlock icon in display is not lit). No steam is produced. In case of the safety interlock being opened by software, status „05“ (Remote off) is displayed instead of „01“.
	02	No demand	Demand from external controller or active humidity sensor is below switch-on threshold of the steam humidifier. No steam is produced (while the safety interlock is closed). The demand icon in the display is not lit.
	03	Humidify	Steam is produced when demand is generated by a Hygrostat or an external controller. With a PI controller setting, an input signal from the active humidity sensor is required. (Safety interlock must be closed).
	05	Remote off	Safety interlock was opened via Modbus (e.g. by a building control system instruction).
	06	No Modbus	When 1-2 = „Modbus“ is selected, demand messages are required on a regular base. In case of no demand within a 20 s time frame, „No Modbus“ is shown as the device status and steam production is stopped (for details, see dedicated Modbus documentation available from HygroMatik GmbH).
	07	Stand-by heating interval	When in stand-by heating mode, status code 07 is displayed during steam production.
	08	Stand-by heating pause	When in stand-by heating mode, status code 08 is displayed when no steam is produced.
Filling category	30	Filling	Filling is active via solenoid valve. The filling icon in the display is lit.
Blow-down category	60	Initial blow-down	After switching the device on, a blow-down sequence is run with the parameter set for partial blow-down.
	61	Partial blow-down	A partial blow-down is run in order to achieve cylinder water concentration reduction. The blow-down icon in the display is lit.

Reading value		Explanation	
Blow-down category (contd.)	62	Full blow-down	Full blow-down is run (steam cylinder is completely drained). The blow-down icon in the display is lit.
	63	Dilution (only for electrode steam humidifiers)	A partial blow-down is run (with the parameter set for partial blow-down) due to a water conductivity too high. The blow-down icon in the display is lit.
	64	Overcurrent blow-down (only for electrode steam humidifiers)	An overcurrent blow-down is run since an electrode current too high was detected by the device. Reducing water level also reduces electrode current. The blow-down icon in the display is lit.
	65	Max. level (only for heater steam humidifiers)	Max. allowable water level in steam cylinder was overrun.
	66	Stand-by blow-down	In case of a safety interlock open for a longer period of time, a full blow-down is run automatically after a time preset in order to avoid stagnant water in the steam cylinder. The blow-down icon in the display is lit.
	67	Dead leg flushing	Special blow-down mode for flushing dead leg tubing. Solenoid valve and blow-down pump are activated simultaneously in case of a no demand situation for a certain period of time. The blow-down icon in the display is lit.
	80	Partial blow-down waiting	Device will start partial blow-down with next filling step.
	81	Full blow-down waiting	Device will start full blow-down with next filling step.
Monitoring category	90	Cylinder full (only for electrode steam humidifiers)	On detection of a an electrical potential at the sensor electrode, cylinder full is reported. In this situation cylinder water level is so high that an electrical bridge between one of the power electrodes and the sensor electrode has built up. The steam icon in the display flashes.
Service category	271	Service steam amount	The service threshold for the steam amount produced as preset in 3-4 was exceeded. The service icon in the display is permanently lit for the time the message is active. The status message may be reset by setting parameter 3-1 to „1“.
	272	Service main contactor K1 switching cycles	The number of main contactor switching cycles predefined by the manufacturer was met. A main contactor replacement is advisable. The service icon in the display is permanently lit for the time the message is active. For resetting the status message, parameter 3-2 must be set to „1“.

Reading value		Explanation	
Fault category	999	Fault	A fault was detected. Operation has ceased. An error code may be read out. Some certain faults also make an icon in the display blink.
r02 Error (only shown when a fault has occurred)		The error code related to the fault is displayed (steam production is stopped whenever a fault occurs). Error codes are described in the „Trouble shooting“ chapter of this manual.	
r04 Actual steam output (imperial units)		Amount of current steam production value [lb/h]	
r05 Actual current (only for electrode steam humidifiers)		Current electrode amperage value [A]	
r06 Filling level (only for heater steam humidifiers)		Filling level [mm] measured by the water level sensor	
r07 Internal control signal		The internal signal for controlling the steam humidifier electrical power delivery is displayed. [%]. This reading is influenced by the control curve and a power limitation preset	
r08 External demand (only with ext. controller)		External controller control signal is displayed [%]	
r09 Power limitation		Power limitation as a percentage of max. output as preset in parameter „1-1“ is displayed [%]	
r10 Set point r.H. (only when PI controller was preset)		R.h. nominal value as preset in parameter 4-1 is displayed [%]	
r11 Actual value r.h. (only when PI controller was preset)		Actual value of r.h. is displayed [%].	
r12 External signal		External signal [%]	
r13 V-Signal		Input signal measured at terminal ST805 [V]	
r14 mA-Signal		Input signal measured at terminal ST806 [mA]	
r15 Ω-Signal		Input signal measured at terminal ST807 [Ω]	

Reading value		Explanation	
r16 Service_ Status	Code	Bezeichnung	Bedeutung
	0	No message	There is no service message.
	1	Steam_ amount counter	The maintenance interval has expired.
	2	Cycles_main_ contactor K1	The maximum number of operating cycles for the main contactor K1 has been reached (the device can contain several main contactors. „x“ represents the designation number of the main contactor concerned).
	3	Cycles_main_ contactor K2	The maximum number of operating cycles for the main contactor K2 has been reached (the device can contain several main contactors. „x“ represents the designation number of the main contactor concerned).
	12	Warning_ - cyl. full (only ELDB)	The sensor electrode continuously reports a full cylinder level for 60 minutes (possibly electrode wear is very advanced).
	13	Warning_ pump	A performance capability decrease is detected in the area of the blow-down pump and its hosing.
	14	Warning_ valve	A performance capability decrease is detected in the area of the solenoid valve, cylinder base and its hosing.
	30	Warning_ cylinder full_ level	Die Sensorelektrode meldet 60 min lang durchgehend einen Zylindervollstand (möglichweise Elektrodenabbrand weit fortgeschritten)

Set value	Explanation
P00 Code level	Allows provider level access by code input (Code „10“) or limitation to user level (Code „0“). Provider level is exited automatically after 10 mins without a keystroke.
PAr Parameter selection	Allows selection of parameter group and of a specific parameter within a group.

3.10 Detailed parameter descriptions

Group	Par.	Denomination	Description
Control	1-1	Steam output limitation	Steam output limitation allows scaling down the max. (steam) output within a range of 25 to 100 %, which may be necessary for a better control performance. The actual steam output is determined by the control signal.
	1-2	Control signal	This parameter tells the unit control software what kind of control signal is wired. Also, the control characteristic is defined. These are the setting options: 1 = external controller, 0...10 V 2 = external controller, 0...20 mA 3 = external controller, 0...140 Ω 4 = PI controller, 0...10 V 5 = PI controller, 4...20 mA 6 = PI controller, 0...140 Ω 7 = 1-step 8 = Modbus
	1-3	Correction of input stages	This parameter allows for an active humidity sensor calibration in the range from -5% r.h. to +5% r.h. .
	1-4	Filter input stage	This parameter allows for switching the damping of the input low pass filter from „light“ to „strong“. With a capacitive humidity sensor, increasing the input damping is meaningful for improving the signal-to-noise ration and for reducing the oscillating tendency.
	1-7	Output_Signal	This parameter sets the output value for the 0-10V analogue output. 0= Off 1= Actuator signal_extern 2= Actuator signal_intern 3= Humidity actual value
Blow-down	2-1	Correction partial blow-down	In case of high electrical conductivity of water or excessive maintenance effort, increasing the blow-down frequency may be meaningful. When conductivity is low, however, a lower blow-down frequency may be adequate. To cope with different water qualities, blow-down rates may be adapted within a range of 10 stages (factory presetting is „0“). Increase blow-down rate: settings up to +5. Decrease blow-down rate: settings up to - 5. A blow-down rate too low will lead to significant wear and tear and will also increase the maintenance effort required. Pls. note: a „-5“ setting will shut off blow-down completely!

Group	Par.	Denomination	Description
Blow-down (contd.)	2-2	Correction full blowdown	see correction partial blow-down
	2-3	Switch stand-by blow-down	Should steam humidifier operation be prospectively halted for a longer period of time, blowing-down the cylinder water is advisable in order to comply with the VDI 6022 hygiene regulations prescribing the prevention of microbial contamination of residual water. Parameter 2-3 is the switch to activate and de-activate the stand-by blow-down function. When activated, a full blow-down is run after a waiting time that was determined by setting parameter 2-4 to the value in question. For stand-by blow-down to become effective, the unit control switch must remain in the „On“- position („I“).
	2-4	Waiting time stand-by blow-down	Determines the waiting time until the cylinder water is fully drained to counteract contamination when no steam is produced for a lengthy period of time (factory setting is 24 hours).
	2-5	Switch dead leg flushing	When parameter 2-5 = „1“, for flushing of the supply line, solenoid valve and blow-down pump are simultaneously activated after the time preset in parameter 2-6 and for the duration of time preset in 2-7. In order for this to work, the safety interlock must be closed.
	2-6	Interval dead leg flushing	Waiting time [h] when there is no steam production until dead leg flushing is activated; only valid if switch 2-5 = „1“.
	2-7	Duration dead leg flushing	Duration of dead leg flushing [s].
	2-8	Blow-down without main contactor K1	During blow-down, leakage currents may flow towards ground through cylinder water. In order to avoid the activation of the leakage sensor circuit-breaker, the main contactor K1 may be switched off during pumping (2-8 = „1“ is designated to „main contactor is switched off during pumping“).
	2-9	Steam-down time	This parameter serves for monitoring proper unit functioning. When steam production is called-for by the control software, a cylinder filling variation must be detectable within the timespan defined by „2-9“. Should this not be registered, the unit enters error state „123“ (error steam-down time) and cuts steam production.

Group	Par.	Denomination	Description
Service	3-1	Reset steam-service interval	On finishing maintenance work, the service interval is to be reset (the service icon is blanked if it was illuminated before).
	3-2	Reset K1 service interval	Main contactor switching cycles are monitored and compared to the life expectancy figure supplied by the part's manufacturer. On a match, reading value r01 is set to „270“ (and the service icon LED flashes). After changing the main contactor, parameter 3-2 must be set to „1“ for a reset of the status message.
	3-4	Steamservice interval	Unit control monitors the actual steam amount produced and compares it with the service steam amount that was determined by the parameter 3-4 setting. When the two data match, the service icon is lit. Steam humidifier operation is not disrupted. Service rate highly depends on water quality (conductivity, hardness) and on the amount of steam produced since the last service. By varying parameter 3-4, the service interval may be adjusted to water quality.
Governing These parameters are only effective when parameter 1-2 (control signal) holds a setting incorporating the PI controller.	4-1	Set point r.h.	Parameter 4-1 determines the r.h. set point for control.
	4-2	Gain PI controller	Sets the PI controller gain (Xp) [%].
	4-3	Integral PI controller	Sets the PI controller resetting time (Xn).
	4-4	Control curves	By setting this parameter, electrode driving may be varied between energy-optimised (4-4 = „0“) and load-optimised (4-4 = „1“). In the first case, when a cold start is run, current is increased to 1.28 times the nominal current. When „load-optimised“ was selected, the increasing factor is only 1.1 in order to not overload the power supply.
	4-5	Offset_dehumidifying	The switchover point between humidification and dehumidification is determined by parameter 4-1 Relative humidity setpoint and 4-5 Offset for dehumidifier. The hysteresis of 1% for dehumidification cannot be changed.

Group	Par.	Denomination	Description
Functions	5-1	Switch stand-by heating	Stand-by heating is enabled or not (0= off, 1=on).
	5-2	Interval stand-by heating	Parameter 5-2 determines the interval time between heating phases when stand-by heating was enabled.
	5-3	On-time Stand-by heating	Parameter 5-3 sets the heating on-time when stand-by heating was enabled.
	5-4	Basic relay allocation	<p>The basic relay features potential-free NC and NO contacts across terminals 28,29 and 29,30, respectively (contact capacity is 250 VAC/8A).</p> <p>The relay is activated when a certain operating status is achieved. Parameter 5-4 allows for allocating a logical function, i.e. the relay is energized when a certain operating status occurs. Factory setting is „0“ defined as „collective fault“</p> <p>The following allocations are supported:</p> <p>(0) Collective fault: Relay is energized in case of any fault.</p> <p>(1) Stand-by: Relay is energized when the unit is in stand-by.</p> <p>(2) No demand: Relay is energized when input signal creates no demand.</p> <p>(3) Humidifying: Relay is energized when humidifying is active.</p> <p>(5) Remote off: Relay is energized when safety interlock was opened under software by means of the building control system.</p> <p>(30) Filling off: Relay is energized when filling is not active.</p> <p>(31) Filling on: Relay is energized when filling.</p>

Group	Par.	Denomination	Description
Functions	5-4	Basic relay allocation (contd.)	<p>(60) Blow-down off: Relay is energized when not pumping.</p> <p>(61) Blow-down on: Relay is energized when pumping takes place.</p> <p>(62) Partial blow-down: Relay is energized when a partial blow-down is run.</p> <p>(63) Full blow-down: Relay is energized when a full blow-down is run.</p> <p>(66) Max. level: Relay is energized when the max. allowable water level is overrun.</p> <p>(67) Stand-by blow down: Relay is energized when a stand-by blow-down is run.</p> <p>(68) Dead leg blow-down: Relay is energized when a dead leg blow-down is run.</p> <p>(69) Start-up blow-down: relay is energized when a start-up blow-down is run.</p> <p>(270) Collective Service: Relay is energized when a service message status („Service steam amount“, „Service main contactor K1 switching cycles“) is active.</p>
	5-5	Relay_K20 allocation	<p>Defines logical function of the optional relay K20 (in the same way as 5-4 does for the basic relay). Factory preset is „270“ (Collective service). Connection ist to plug ST10.1 on the mainboard.</p> <p>Exception: For the units SLH40 and SLH50 the relay_K20 is used as standard to switch the level 2 (i.e. the single-level control of 3 heaters).. The relay assignment is set to "120" at the factory and cannot be changed.</p>
	5-6	Modbus address	<p>The control electronic may optionally be equipped with a RS485 serial interface for running data communication with the Modbus RTU protocol. 5-6 then holds the Modbus RTU address.</p>
	5-7	Relay_K21 allocation	<p>Defines logical function of the optional relay K21 (in the same way as 5-4 does for the basic relay). Factory preset is „270“ (Collective service). Connection ist to plug ST10.2 on the mainboard.</p>

Group	Par.	Denomina- tion	Description
Settings	6-1	Buzzer	The control panel features a buzzer for prompting key strokes. Parameter 6-1 allows for muting the prompt.
	6-2	Time-Out	Unit control switches the display back to actual steam output presentation after the time set in 6-2. Factory setting is „2 minutes“
	6-3	Imperial units	This parameter enables a switch between SI units and imperial units. Actual steam output e.g. will then be in „lb/h“ instead of „kg/h“.





4. Trouble shooting



4.1 Error handling





On occurrence of a fault, steam production is stopped. The control panel display is switched to error code output. In the same instance, the general fault icon  starts flashing.





On „Steam production“, „Main contactor“, „Filling“ and „Blow-down“ faults, the respective icon is additionally blinked.



4.1.1 Table of possible faults and related error codes



Icons	Code	Error message	Possible cause	Counter measure
	000	No error		
	001	Sensor plug (ST09)	<ul style="list-style-type: none"> • Plug not attached or loose 	<ul style="list-style-type: none"> • Check plug
	022 *)	Input_current_min The min. value of the input signal is no plausibel	<ul style="list-style-type: none"> • Sensor, wiring or signal source defective • Input stage defective 	<ul style="list-style-type: none"> • Check sensor, wiring and signal source, if relevant • Replace mainboard
	024 025 *)	Input_resistance_OC Input_resistance_SC The resistance measured is not correct („infinite“ or „zero“, resp.)	<ul style="list-style-type: none"> • Sensor, input wiring or signal source not correct • Input stage defective 	<ul style="list-style-type: none"> • Check sensor, signal cable and signal source, if applicable • Replace main PCB
*) When a PI controller is in use, errors 022-025 relate to the sensor output signals. With an external controller the controller output signal is concerned.				
	029	System failure	<ul style="list-style-type: none"> • Main PCB is defective 	<ul style="list-style-type: none"> • Replace main PCB

Icons	Code	Error message	Possible cause	Counter measure
 	030	<p>Filling</p> <p>Filling was not successful, i.e. the expected filling level was not achieved after a device-specific time (15 - 45 min)</p>	<ul style="list-style-type: none"> • Solenoid valve or water supply line contaminated or defective • Solenoid valve defective • Water supply not opened • Solenoid valve electrically not driven <ul style="list-style-type: none"> - electrical cabling not o.k. - Main PCB relay not energized • Steam hose not laid with sufficient incline/decline resulting in a water bag obstructing steam flow. Steam builds up pressure in steam cylinder and pushes water towards drain • Blockage in steam pipe impedes the steam flow. 	<ul style="list-style-type: none"> • Clean water supply line and/or solenoid valve; replace solenoid valve, if defective • Make measurement on solenoid; replace solenoid valve, if defective • Open water supply -Check electrical cable and replace, if required - Measure voltage on main PCB terminal 11 against N; replace PCB, if required • Check steam hose layout. Eliminate water bag. • Remove blockage in steam pipe
			<ul style="list-style-type: none"> • L3 phase break-down 	<ul style="list-style-type: none"> • Reestablish L3 phase feeding
			<ul style="list-style-type: none"> • Main contactor does not switch L3 phase 	<ul style="list-style-type: none"> • Replace main contactor

Icons	Code	Error message	Possible cause	Counter measure
	<p>061 062 063 064 065 066 067</p>	<p>Blow-down fault, relates to:</p> <p>Partial blow-down Full blow-down Dilution (only for electrode steam humidifiers) Overcurrent blow-down (only for electrode steam humidifiers) Max level blow-down (only for heater steam humidifiers) Stand-by blow-down Start_blow-down (only for heater steam humidifiers)</p> <p>Indicated blow-down was not successful</p>	<ul style="list-style-type: none"> • Blow-down pump not driven • electrical wiring not o.k. • Main PCB relay not energized • Blow-down pump defective • Blow-down pump working but water is not drained (i.e. cylinder drain is blocked) • Blow-down pump blocked by hardeners • Water sensor defective (only for heater steam humidifiers) 	<ul style="list-style-type: none"> - Check wiring and replace, if required - Measure voltage on main PCB terminal 10 against N; replace PCB, if required • Replace blow-down pump • Clean cylinder and cylinder base carefully to ensure that no blocking will occur in the near future • Check blow-down pump, drainage system and steam cylinder for hardeners and clean • Replace water sensor
	<p>090</p>	<p>Cylinder full Sensor electrode continuously signals full cylinder for 60 mins (only for electrode steam humidifiers)</p>	<ul style="list-style-type: none"> • low or strongly fluctuating water conductivity • Electrodes used up • No electrode cable run through current transducer • Salt bridges in steamcylinder upper part • Foaming (when softened water is used) 	<ul style="list-style-type: none"> • Check feed water quality • Replace electrodes • Run one phase through current transducer • Clean • Increase blending rate
	<p>091</p>	<p>Current measurement Current transducer supplies faulty measurement (only for electrode steam humidifiers)</p>	<ul style="list-style-type: none"> • Plug is not seated properly on main PCB • Current transducer defective 	<ul style="list-style-type: none"> • Check plug seating • Replace current transducer
	<p>092</p>	<p>Main contactor current Current measured though the main contactor is not driven (only for electrode steam humidifiers)</p>	<ul style="list-style-type: none"> • Main contactor contact sticks 	<ul style="list-style-type: none"> • Check main contactor, replace it if required • Measure voltage across terminal 9 and N. Replace PCB, if required

Icons	Code	Error message	Possible cause	Counter measure
	093	Main contactor cylinder full „Cylinder full“ is detected though main contactor is not driven (only for electrode steam humidifiers)	<ul style="list-style-type: none"> • Main contactor contact sticks 	<ul style="list-style-type: none"> • Replace main contactor • Measure voltage across terminal 9 and N. Replace PCB, if required
	120	Thermo switch One of the thermo switches has triggered (only for heater steam humidifiers)	<ul style="list-style-type: none"> • Thermo switch on steam cylinder cover has triggered due to lime coating on heating element • Capillary tube defective • Thermo switch on solid state relay has triggered due to blocked ventilation • Blockage in a connection hose (see no. 21/22 in the exploded view) leads to incorrect water level detection, which can cause the thermal switch to trip. 	<ul style="list-style-type: none"> • Switch off power supply. Remove lime coating. Allow cool-down of steam cylinder. Push-back unblocking pin on thermo switch with needle-nose pliers or a screwdriver • Replace thermo switch • Switch off unit. Allow cool-down of heat sink. Restart humidifier operation. • Replace the blocked connection hose. Switch the device on again.
	121	Water sensor Water sensor output signal not plausible	<ul style="list-style-type: none"> • Water sensor is defective • Connecting hoses blocked 	<ul style="list-style-type: none"> • Replace water sensor • Clean hoses
	122	Max. level Maximum water level was achieved 5 times (only for heater steam humidifiers)	<ul style="list-style-type: none"> • Excessive air pressure in duct has impact on water in steam cylinder via steam hose. Water is pressed into drainage • Solenoid valve closing action imperfect. Cylinder water level rises though solenoid valve is not energized • Solenoid valve is permanently energized (water intake stops when unit is switched off) • Large amounts of residues influence or restrict cyclic blow-down. The additional water introduction caused by the optional SuperFlush rinse device may cause the max. level fault 	<ul style="list-style-type: none"> • Reduce air pressure • Check steam pipe for blockage • Check solenoid valve • Relay on main PCB stuck. Measure voltage across terminal 11 and N. Replace PCB, if required • Clean steam cylinder, cylinder base, water sensor tubing and drainage system

Icons	Code	Error message	Possible cause	Counter measure
  	123	Steam down time Heater element (s) is/are driven but water level remains constant (only for heater steam humidifiers)	<ul style="list-style-type: none"> • Heater element is defective • Phase loss (external circuit breaker has tripped or is defective) • No voltage supplied to heater element(s) • No proper main contactor switching action • Main contactor is not energized by PCB 	<ul style="list-style-type: none"> • Measure heater element resistance, replace heater element, if required. Typical resistance values are: <ul style="list-style-type: none"> SLH03 - 2,25kW/230V - 21,3-26,1Ω SLH06 - 4,5kW/400V - 32,3-39,5Ω SLH09 - 6,75kW/400V - 21,5-26,3Ω SLH15 - 3,8kW/400V - 38,2-46,8Ω (3x) SLH25 - 6,3kW/400V - 23,1-28,2Ω (3x) SLH40 - 6,3kW/400V - 23,1-28,2Ω (3x) + 3,8kW/400V - 38,2-46,8Ω (3x) SLH50 - 6,3kW/400V - 23,1-28,2Ω (6x) KIT H02 - 1.5 kW/230V/ 32-39.2 Ω KIT H03 - 2.25 kW/230V - 21.3-26.1 Ω KIT H06 - 4.5 kW/400V - 32.3-39.5 Ω KIT H09 - 6.75 kW/400V - 21.5-26.3 Ω KIT H15 - 3.8 kW/400V - 38.2-46.8 Ω (3x) <ul style="list-style-type: none"> • Check circuit breaker, find reason for tripping • Check wiring, measure voltage • Check and replace main contactor, if required • Verify voltage across PCB terminal 9 and N. Replace PCB, if required

Icons	Code	Error message	Possible cause	Counter measure
	124	Main contactor coil Voltage detected across coil though main contactor is not driven by control logic (only for heater steam humidifiers)	<ul style="list-style-type: none"> • Relay K4 on main PCB is stuck 	<ul style="list-style-type: none"> • Check main contactor, replace it if required • Measure voltage across terminal 9.1 and 9.2. Measure voltage across terminal 9 and N. Replace PCB, if required
	210	R.h. sensor Humidity sensor signal implausibility	<ul style="list-style-type: none"> • Sensor cable defective • Sensor defective 	<ul style="list-style-type: none"> • Check sensor cable • Replace sensor
	ErL	Error Link no communication between mainboard and display	<ul style="list-style-type: none"> • Mainboard or display unit defective 	<ul style="list-style-type: none"> • Replace mainboard or display unit

4.2 Table of functional disruptions

Problem	Possible cause for faulty situation	Counter measure
Set humidity level not reached	<ul style="list-style-type: none"> • Output limitation parameter setting impedes full power output • Nominal unit output insufficient • Phase failure or defective heater element(s) • Thermo switch has triggered • Lengthy steam hose layout crossing cold and drafty rooms may lead to increased condensate formation • Improper steam manifold installation may cause condensate formation within air duct • Control signal not properly selected or software setting mismatch • Excessive pressure in duct system caused by e.g. water bags or partly blocked steam pipes (max. overpressure is 1200 Pa) 	<ul style="list-style-type: none"> • Check 1-1 parameter setting • Check unit technical data, air-flow and secondary airflow • Check circuit breakers and heater element(s) • Switch off power supply. Push-back unblocking pin on thermo switch with needle-nose pliers or a screwdriver • Change unit installation location allowing for shorter steam hose. Insulate steam hose • Check steam manifold position within total system and installation correctness • Check control signal and „1-2“ parameter setting • Eliminate particular cause(s)
Excessive humidity	<ul style="list-style-type: none"> • Water quality requires salt concentration of the water for full steam output (only for electrode steam humidifiers) • A steam output limitation setting that is too high may result in poor control performance and even condensate formation in ducts • Control signal not properly selected or software setting mismatch 	<ul style="list-style-type: none"> • Wait • Check „1-1“ parameter setting • Check control signal and „1-2“ parameter setting
Water collects on bottom plate	<ul style="list-style-type: none"> • Cylinder improperly reassembled following maintenance: <ul style="list-style-type: none"> - O-ring not replaced, defective or not in place - Flange (tongue and groove) damaged - Flange improperly composed - Mineral deposits in flange area • Cylinder improperly inserted in cylinder base • Water cannot drain freely when pumped from cylinder 	<ul style="list-style-type: none"> • Clean cylinder and assemble / install properly • Using moistened new O-ring, insert steam cylinder properly into cylinder base • Make sure drain is unobstructed

Problem	Possible cause for faulty situation	Counter measure
Water leaks from steam cylinder upper part	<ul style="list-style-type: none"> • Hose clamps on steam and/or condensate hose not tightened • Steam hose adapter not properly fit or O-ring not replaced 	<ul style="list-style-type: none"> • Tighten clamps • Replace O-ring (if required) and ensure proper adapter installation
No steam production despite the steam humidifier being switched on. Display not illuminated.	<ul style="list-style-type: none"> • Defective F1 and/or F2 fuses (1.6 A each) • L3 phase failure (ext. circuit breaker has tripped or is defective) • device load circuit breaker has tripped 	<ul style="list-style-type: none"> • Check micro fuses and replace, if required • Replace breaker and investigate possible causes • Switch on breaker. If problem persists, check for reason
No steam production despite the steam generator being switched on and an illuminated display	<ul style="list-style-type: none"> • The interlock (safety) system is open • The humidity set value has been reached. The control receives no demand for steam production. • A fault has occurred 	<ul style="list-style-type: none"> • Close interlock (safety) system • Check humidity set value and plausibility of actual humidity value • Check unit status
No steam production. Voltage across electrodes exist, but no water is fed into the cylinder (only EL-DB)	<ul style="list-style-type: none"> • Water supply not opened or solenoid valve electrically not driven 	<ul style="list-style-type: none"> • Open water supply (s. also Filling fault messages 030)
Blow-down pump works but not water is drained	<ul style="list-style-type: none"> • Steam cylinder and/or drainage system blocked 	<ul style="list-style-type: none"> • Clean cylinder base and/or drainage system, respectively
Cylinder is fully drained after partial blow-down despite switched-off pump	<ul style="list-style-type: none"> • Vent pipe is blocked 	<ul style="list-style-type: none"> • Clean venting bore or replace vent pipe adapter

Problem	Possible cause for faulty situation	Counter measure
<p>No steam exit from steam manifold</p> <p>Water exits periodically from drain hose without pump switched on</p>	<ul style="list-style-type: none"> • Steam pipe improperly laid (water bag). • Excess pressure in duct system (max. overpressure is 1200 Pa/.17 psi) 	<ul style="list-style-type: none"> • Rerun steam hose according to guide lines • Consult your expert dealer if problem persists
<p>Uneven electrode wear</p>	<p>(only for electrode steam humidifiers)</p> <ul style="list-style-type: none"> • One or more electrodes not supplied with power • Circuit breaker tripped • Main contactor contact not functional • Phase loading not symmetric • Electrode immersion depth differs. Unit not mounted plumb 	<ul style="list-style-type: none"> • Check power supply and wiring • Check circuit breaker. Replace, if required • Check main contactor. Replace, if required • Ensure power supply phase balance by measurement • Check installation and correct positioning, if required
<p>Flashover/sparks in cylinder</p>	<p>(only for electrode steam humidifiers)</p> <ul style="list-style-type: none"> • Very high water conductivity resulting in massive electrode burn-off as indicated by brown-black deposits • Blow-down pump not working properly or defective 	<ul style="list-style-type: none"> • Deactivate unit immediately to prevent material damage <p>Perform maintenance:</p> <ul style="list-style-type: none"> - replace electrodes - clean steam cylinder - check water quality and conductivity (also s. „Intended use“ section) <p>If problem persists, increase blow-down frequency and/or blow-down volume</p> <p>Consult your expert dealer, if required</p> <p>Check blow-down pump functioning and replace pump, if required. See also „Blow down fault“ error message</p>

HygroMATIK®

Lise-Meitner-Str.3 • D-24558 Henstedt-Ulzburg
Phone +49(0)4193/ 895-0 • Fax -33
eMail hy@hygromatik.de • www.hygromatik.com
member of **CAREL Group**

