

Softener devices

WaterLine Single

WaterLine Double

WaterLine Double Plus



Copyright © HygroMatik GmbH [23.09.2020]

WL-S/D/DP EN

All rights reserved



Warning! Hazardous Voltage: All work to be performed by trained personnel only. All electrical installation and servicing of the electrical components of this unit to be performed by qualified electricians only. Disconnect power supply before installation and servicing!

1. Introduction	5
1.1 Intended Use	5
1.2 Typographic markings	6
1.3 Documentation	6
2. Safety instructions	7
2.1 General information	7
2.2 Safety instructions for the installation and start-up of the softener device	7
2.3 Safety regulations for the operation of the softener device	8
2.4 Safety instructions for working on electrical equipment	9
2.5 Disposal upon disassembly	9
3. Transport	10
3.1 General Information	10
3.2 Temporary storage	10
3.3 Inspecting for correctness and completeness	10
3.4 Scope of delivery	10
3.5 Packaging and return consignment	10
4. Functionality and device composition	11
4.1 Principle of operation	11
4.2 WL-S and WL-D/DP device composition	11
4.3 Use of optional chlorine cell	14
4.4 Operating cycles	14
4.4.1 Softening	14
4.4.2 Regenerate	14
4.5 Brine	17
5. Installation	18
5.1 Basic prerequisites for operating the WaterLine softener device	18
5.2 Selecting the correct installation location of the Waterline softener device within the plumber installation scenario	18
5.3 Requirements on the installation site of the WaterLine softener device	19
5.4 Set-up of the WaterLine pendulum devices WL-D/DP	19
5.5 Attaching the tubing for raw water and soft water	19
5.5.1 Prerequisites for the correct connection of the tubing on the softener device	19
5.5.2 Connecting the control valve to the house water installation	20
5.5.3 Connecting the control valve to the optional mounting block	21
5.6 Connecting of brine tube	21
5.7 Make waste water connection	22
5.8 Connecting the brine tank overflow	22
6. Start-up	23
6.1 Operating the control valve for the first time	23
6.2 Run forced regeneration	24
6.3 Filling the brine tank with salt tablets	24
6.4 Programming the control valve	24
6.5 Setting of the optional external blendingvalve	26

6.6 Finalizing start-up	27
7. Programming of the control valve	28
7.1 General information	28
7.2 Operating the control valve	28
7.2.1 Deactivating and re-activation of the valve lock	28
7.2.2 Initiation of an exchange of the tank in service	29
7.3 Basic Programming Structure	29
7.4 Overview on the display and operating options for the device operator (Level 1, normal operation)	29
7.5 Control valve programming steps	30
7.5.1 Set time of the day	30
7.5.2 Display of current water flow and remaining capacity	30
7.5.3 Triggering an ahead-of-schedule regeneration on reaching the time set for the first time	31
7.5.4 Triggering an instantaneous regeneration cycle	31
8. Maintenance	32
8.1 General information	32
8.2 Maintenance work to be carried out by the device operator	32
8.2.1 Daily check of proper device operation	32
8.2.2 Bimonthly inspection	34
8.2.3 Minor Maintenance (every 6 months)	34
8.3 Full maintenance	36
8.4 Troubleshooting	36
9. Removal from service, storage and recommissioning	37
9.1 Removal from service	37
9.2 Storage	37
9.3 Recommissioning	37
10. Optional chlorine cell	39
10.1 Functional description and design	39
10.2 Mounting the device	39
10.3 Setting-up the control device	40
10.4 Operating	40
10.5 Chlorine cell maintenance	40
10.6 Technical specifications	41
10. Technical specifications	42
11. Spare parts	46

1. Introduction

Dear customer,

thank you very much for choosing a HygroMatik cabinet ion exchanger device (softener device).

In order to operate your HygroMatik softener device safely, properly and economically please carefully study this operation manual.

Only use your HygroMatik softener device when in flawless condition as well as according to its intended use, safety and hazard conscious and in compliance with all hints and restriction given in this operation manual.

For any further questions please contact HygroMatik as follows:

Tel.: +49-(0)4193 / 895-0 (Main office)

Tel.: +49-(0)4193 / 895-293 (Technical Hotline)

Fax: +49-(0)4193 / 895-33

e-mail: hotline@HygroMatik.de

For any queries or ordering of spare parts please have your device data ready!

1.1 Intended Use

The HygroMatik cabinet ion exchanger device (softener device) is ment for the production of soft water. It may only be used according to its intended use.



Caution: Proper use includes fulfilment of the assembly, disassembly, reassembly, start-up, operating and maintenance conditions specified by us as well as disposal measures.

Only appointed qualified staff may work on or with the system. Persons transporting or working on or with the system must have read and understood the relevant parts of this operating manual, particularly the 'Safety instructions' section. Staff must also be informed of possible hazards by the operating company. Please keep a copy of the operating manual at the location where the device is being used.

Any **additional equipment** may only be built into any parts of the softener device with the written permission of the HygroMatik GmbH.

WaterLine softener device utilization

- The intended case of application is the operation within the area of **drinking water** supply.
- All TVO (Trinkwasserverordnung = Drinking Water Ordinance) **limit and guide values** must be respected. The

iron (Fe) content limit is 0.2 mg/l, max. manganese (Mn) is 0.05 mg/l

- For use with raw water with an **iron (Fe) and/or manganese (Mn)** content exceeding these limits, only HygroMatik WaterLine softeners of the WL-DP family type are suited. These devices allow for a max. Fe of 15 mg/l and Mn of max. 3 mg/l.
- The softener device must **not be operated outside** in the exterior
- **Frost protection** and **humidity protection** must be ensured
- Allowable **environmental temperature** is 5 - 40 °C with a max. r.h. of 60 percent
- Use of a **system separator** according to EN 1717 (former DIN 1998, part 4) is obligatory
- Optimum **flow pressure** of the device is 4.0 bar



Please note: For protection of the softener device, a **water filter** according to DIN 13443-1 implemented upstream of the water intake is obligatory. Without such a filter the ion exchanger resin might silt-up within short periods of time. Also, the control valve might get damaged by dirt ingress.

1.2 Typographic markings

- lists with items beginning with bullets: general lists
- » lists with items beginning with arrows: work or operating steps which should or must be carried out in the specified order
- installation steps which must be checked
- italics* figure and plan names

1.3 Documentation

Storage

Please keep this operating manual in a safe place where it is accessible at all times. If you sell the product, be sure to include this manual. Please contact HygroMatik if the documentation is lost.

Language versions

This operating manual is available in different languages. Please contact your HygroMatik dealer or HygroMatik for details.

2. Safety instructions

2.1 General information

The safety instructions are prescribed by law. They are intended to ensure health and safety at work and accident prevention.

Warnings and safety symbols

The following safety symbols are used in this manual to indicate hazard and risk warnings. Please familiarise yourself with these symbols



Caution: Failure to heed this warning may result in injury or danger to life and limb and/or damage to the device.



Caution:Voltage: Dangerous electrical voltage! Failure to heed this warning may result in injury or danger to life and limb.



Indicates materials and consumables which must be handled and/or disposed of in accordance with statutory requirements.



Please note: precedes explanations for or cross-references to other places in the text. Also, information is marked in this way that requires particular observance.

General safety instructions for working on WaterLine softener devices



Caution: Prior to working on the softener device water supply must be cut



Caution: The device may be under pressure. Prior to working on the device pressure must be released.

2.2 Safety instructions for the installation and start-up of the softener device

- Integration of the softener device into the plumber installation scenario must only be carried out by a plumbing company. Local and regional regulations must be obeyed without exemption
- The electrical connection and programming of the softener device may only be made by trained personnel

- Please also consider **water flow pressure** in your supply situation. The allowable pressure range is 2.5 to 7.0 bar. If pressure lies above that, a pressure reducer must be installed
- As a **protection against water damage**, a gully is recommended. If not available, alternatively a water-stop may be used
- The installation ground must be imperatively level and dry. The device is to be placed in a way that tilting by accidental impact is not possible
- Please consider adequate **distance to heat sources**
- We recommend the sole use of pipes made from **plastic or stainless steel**. Zinc plated water pipes are not suited for use with zero hardness water

2.3 Safety regulations for the operation of the softener device

General

- Any form of using the device that impairs the safety of the device must be refrained from
- Please observe all safety and hazard signs on the device
- On functional failures switch-off the device immediately and secure against switching on again. Clear any faults on the spot
- After repair work operational safety must be assured by expert staff
- Only use original spare parts
- All other national regulations beyond the a.m. coverage apply without restriction for operating the device

Use by persons not entitled

This device is not intended for the use by persons (including children) with limited physical, sensoric or mental capabilities or lacking experience and/or non-existing knowledge unless supervised by a person responsible for the user's safety or prior instructions given in the use of the device. Children should be kept an eye on to make sure that no playing with the device happens.

Operational safety

- For your own safety regularly inspect connecting pipes and hoses to minimize the **risk of flooding**
- Check the brine tank in a regular time frame to make sure that **regeneration salt is always available** in sufficient volume in order not to limit the functional capability of the device

- To avoid contamination by dust or pest, the brine tank should always be closed with the appropriate **cover**
- Even when not in use for a longer period of time, the device should remain switched on since hygienic regenerations are run in stand-by also

2.4 Safety instructions for working on electrical equipment



Warning: Only expert personnel is permitted to work on the electrical system and the control cabinet (if applicable).



Risk of electrical shock! Prior to working on the electrical equipment of the softener device always cut the mains connection by unplugging the power adaptor. Make sure never to touch electrical components with wet hands.

Switch off the system immediately if faults in the electrical energy supply occur.

Only use original fuses with the specified amperage.

Inspect the system's electrical equipment at regular intervals. Promptly eliminate deficiencies, such as loose connections or melted cables. After carrying out the corresponding electrical assembly or maintenance work, test all protective measures used (e.g. earth resistance).

Accident prevention regulations



Caution: Heed the HSW (Health and Safety at Work) regulations for electrical installations and equipment (VBG4/BGVA3). By doing so you protect yourself and others from harm.

2.5 Disposal upon disassembly



The operating company is responsible for disposal of the system parts in accordance with statutory requirements.

3. Transport

3.1 General Information



Please note: Take care when transporting the HygroMatik softener device to prevent the device and packaging from being damaged.



Warning: Pressure tanks are very impact sensitive und must not be rolled.

3.2 Temporary storage

Store the device in a dry and frost-free place.

3.3 Inspecting for correctness and completeness

When you receive the goods, ensure that the equipment is complete and all parts are in perfect condition.



Please note: Any transport damages and/or missing parts must be reported immediately to the shipper or supplier.

The periods in which notification of the transport company must occur for the purposes of identifying the damage are as follows*:

Transport company	Time after receipt of goods
Post	no later than 24 hours
Rail	7 days at the latest
Rail and road transport companies	4 days at the latest
Parcel services	immediately

* Periods are subject to change without notice.

3.4 Scope of delivery

The following items are included in the delivery:

- Softener device (in case of a device featuring two pressure tanks, the second tank is separately packaged)
- Operating manual(s)
- Accessories ordered

3.5 Packaging and return consignment

Should return consignment be necessary, please consider the following:

- Preferably use euro pallet for packaging
- Ensure frost and humidity protection during transport
- Take care when handling pressure tanks

4. Functionality and device composition

4.1 Principle of operation

The HygroMatik softener device makes use of the ion exchange method for replacing magnesium and calcium as well as strontium and barium by sodium, thus producing so called soft water. The device works using the concurrent process and was designed for normal salting.

The raw water fed to the softener must be iron- and manganese-free. For use with raw water not complying to this prerequisite, the WaterLine double softener device family WL-DP featuring a special compatible resin filling may be used.

After the production of a set volume of soft water, regeneration occurs on a regular base. For that purpose brine water is sucked from the brine tank into the exchanger (pressure tank). Because of the extremely high concentration of sodium in the brine the hardness components bound are exchanged again with sodium. The regeneration waste water is drained to a canal. On finishing the regeneration cycle, the brine tank is filled-up again with water to allow for the production of new brine.

Besides the volume based regeneration, forced regeneration is carried out on a regular base to ensure proper hygienic conditions. Otherwise, the softener may be prone to microbial contamination if no water flow exists due to longer periods of non-usage (e.g. during holiday periods) Pre-setting for forced regeneration is 4 days. This setting may be changed by the operator.

Since the WaterLine WL-S softener device features only one pressure tank, the device is not available for soft water production during regeneration. In contrast to this, the WaterLine softener devices WL-D and WL-DP are equipped with two pressure tanks each, allowing for soft water production in the one tank while - in parallel - the resin in the other tank is regenerated. Because of this mechanism, these devices are designated as „pendulum systems“. When the resin in the active pressure tank is exhausted, the control valve switches to the other pressure tank holding freshly regenerated resin of full capacity. Switching between the two pressure tanks is accomplished by the motorized alternator valve integrated into the control valve.



Control valve for WL-S, view



Control valve for WL-D/DP, view

4.2 WL-S and WL-D/DP device composition

The systems are composed of a brine tank and one or two exchangers. The resin-filled exchangers are pressure tanks made from GRP. On top of the pressure tank (or one of the pressure tanks in case of the WaterLine WL-D/DP systems) sits the control valve. The control valve holds a displaceable piston for supporting all of the steps of the ion exchanger and regeneration processes and the microprocessor-based control logic.

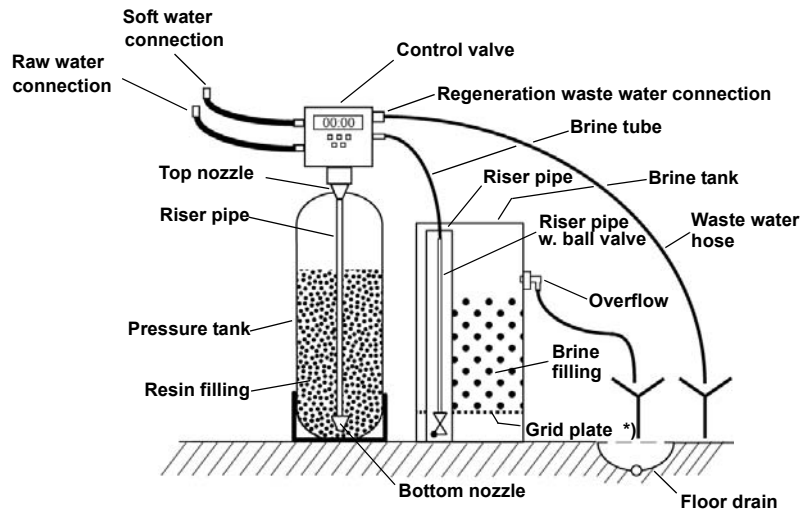

*) Grid plate only when resin capacity is 100 m³ x °dH or higher

Principle design of WaterLine softener device WL-S

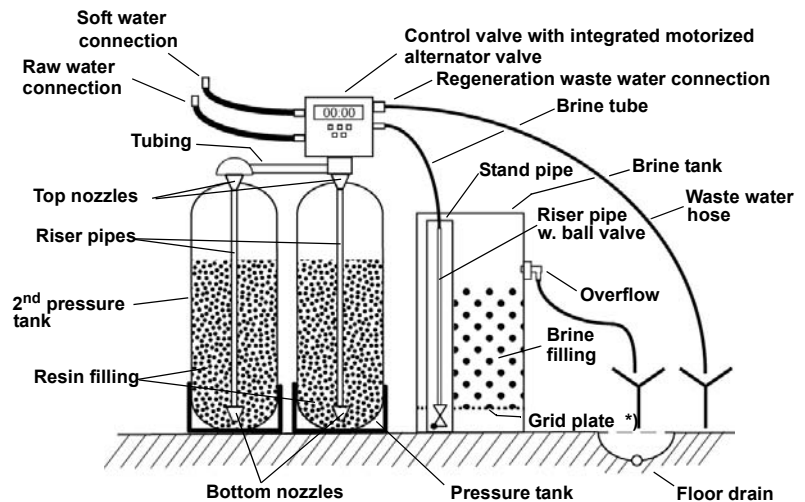

*) Grid plate only when resin capacity is 100 m³ x °dH or higher

Principle design of WaterLine softener device WL-D/DP

Arranged in the brine tank is a stand pipe holding a riser pipe for brine sucking. The bottom end of the riser pipe features a ball valve that blocks sucking when the brine level has sunk accordingly. The riser pipe top end is connected to the control valve through a brine tube.

The control valve is connected to the house water installation either directly or via a (optionally available) mounting block through hoses for water inlet and water outlet (optionally available water connection set including titration kit may be used).

Hose connections make use of the provided BSPT adaptors (BSPT = British Standard Pipe Thread).

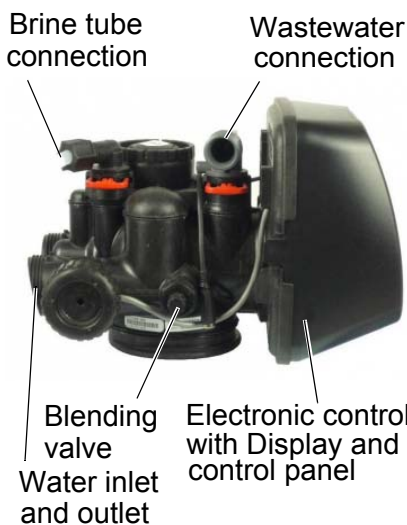

Control valve for WL-S, connections

Pendulum systems feature a single control valve with the expanded functionality for automatic switching between pressure tanks. The tank without a control valve is connected to the control valve on the other pressure tank via tubings for raw and soft water.

The waste water hose is connected to a 3/4 inch elbow on the control valve. Draining must feature an open outlet in order to prevent microbiological contamination.

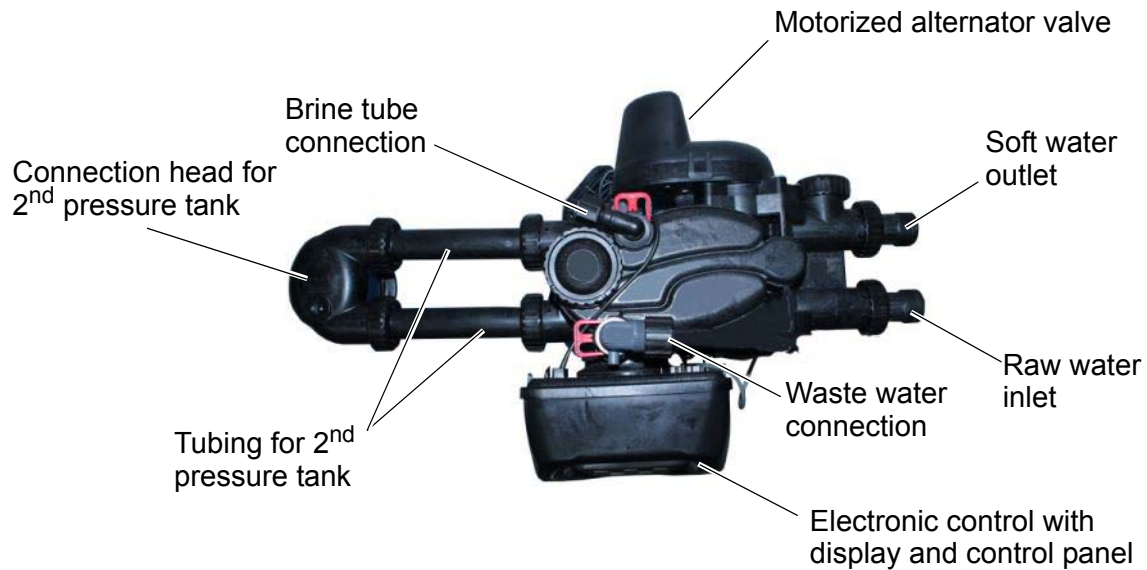

Control valve for WL- D/DP, connections



Display and control panel of control valve for WL-S and WL-D/P

The control logic comprises a display for time of day presentation as well as the preset and programmable parameters of the ion changer process. Operating and programming is accomplished by use of the 5 keys designated „SET CLOCK“, „NEXT“, „REGEN“ as well as „Δ“ und „∇“ (up/down-arrows for increasing/decreasing settings).

4.3 Use of optional chlorine cell

Periodical chlorination of the raw water feed to a softener device is meaningful in order to fight microbiological contamination in the exchangers and pipes by chemical means. For this purpose, a chlorine cell may be inserted in the brine tube by use of a t-piece connector that produces active chlorine. Any excessive chlorine is washed out with the regeneration waste water. How to use the chlorine cell is described in a chapter of its own.

4.4 Operating cycles

Normal operation mode of the WaterLine softener devices is „softening“. Alternating to this (in case of single systems) or in parallel (with double systems), then in the currently not active exchanger, „regenerating“ is carried out. The following operating cycles can be distinguished in detail:

Normal operation

- Softening

Regeneration

- Backwash
- Brine and Slow wash
- Rinse
- Fill (brine tank)

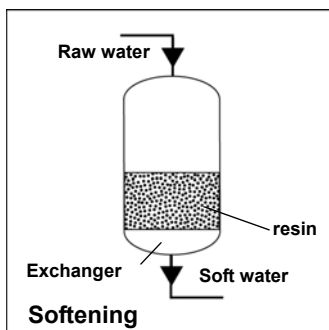

4.4.1 Softening

This is the normal operation mode of the WaterLine softener device. The control valve guides raw water into the pressure tank filled with exchanger resin. Raw water flows top down through the resin while the resin absorbs magnesium and calcium ions, exchanging them with sodium ions. By this mechanism, softened water is generated. The product water enters the rise pipe in the pressure tank through the bottom nozzle and is subsequently propagated to the control valve and, finally, to the consumer through the product water pipe.

4.4.2 Regenerate

Since the exchange capacity of the resin is exhausted after a certain volume of soft water produced, regeneration is required on a regular time frame. For this purpose, NaCl brine is used that is produced by dissolving salt tablets in the brine tank.

Regeneration point of time is determined by the control valve. To enable this, „soft water capacity“ with respect to the Waterline device capacity and local raw water hardness must be programmed into the control valve logic. On reaching the threshold set, automatic regeneration will result. The number of regeneration occurrences is only restricted by resin life time.



Please note: The dimensioning of the WaterLine softener device must be such that soft water demand does not exceed the soft water capacity between any two regenerations.

The regeneration process is separated in the partial steps „back-wash“, „brine/slow wash“, „rinse “ and „fill“.

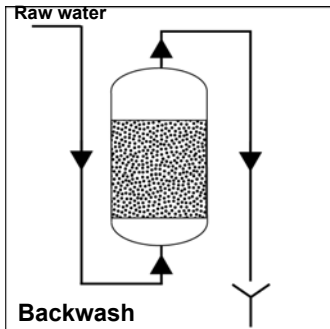

4.4.2.1 Backwash

Under control valve regime raw water is fed bottom up through the exchanger resin in the pressure tank, thus causing disaggregation of the resin.

4.4.2.2 Brine and slow wash

In the brine tank, a 25 percent brine is prepared from raw water and NaCl.



Please note: Building up the required brine concentration takes 6 hours of time minimum. Such, any two regenerations should be separated by at least this time interval.

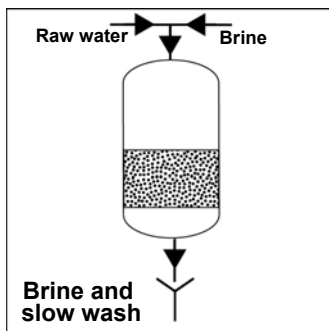

Brine is sucked up by the control valve injector and blended with raw water to a 10 to 12 percent concentration, which is the optimum concentration for the regeneration process. The diluted brine is fed through the resin top down. Now ion exchange takes place in the inverted direction as compared to softening, setting free and draining calcium- and magnesium ions bonded by the resin. Following brining, slow wash is carried out in the following way: When no more brine is sucked by the injector, only raw water flows through the resin bed in the pressure tank. Any brine left in the pressure tank is swamped out by and by.

4.4.2.3 Rinse

Following slow wash, rinse is carried out with raw water guided through the pressure tank top down. After a flushed water volume corresponding to 3 to 4 times the resin filling volume, proper soft water may again be produced.

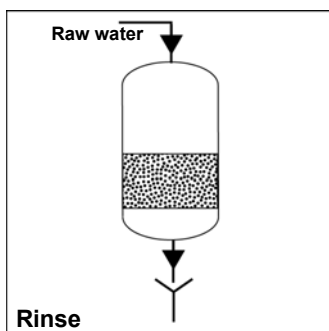

4.4.2.4 Fill

The brine tank is filled-up automatically with a defined volume of water. After filling the regeneration process is terminated and the control valve sets the WaterLine softener device back to normal operation.

4.4.2.5 Duration of the regeneration steps

Duration of the individual regeneration steps may be programmed by the operator (s. chapter 7 for details). Typical recommended settings are as such:

Backwash: 3 - 5 mins.

Brine/Slow wash: total time 45 mins. (brine is fully sucked-up in approx. half of the time)

Rinse: 5 - 8 mins.

Fill: this „time“ is not set in minutes but is expressed by the salt volume (in kg) needed per regeneration event. The individual WaterLine softener models require the following settings:

Model	Resin volume [l]	Amount of salt [kg]*)	
		Full brining	Partial brining
WL-S-20	5	1.1	0.8
WL-S-40	10	2.2	1.6
WL-S-60	15	3.3	2.4
WL-S-80	20	4.4	3.2
WL-D-20	5	1.1	0.8
WL-D-40	10	2.2	1.6
WL-D-60	15	3.3	2.4
WL-D-80	20	4.4	3.2
WL-D-100	25	5.5	4
WL-D-160	40	8.8	6.4
WL-D-200	50	11	8
WL-D-240	60	13.2	9.6
WL-D-300	75	16.5	12
WL-D-400	100	22	16
WL-D-500	125	27.5	20
WL-DP-30	12	1.2	not possible
WL-DP-62	25	2.5	not possible
WL-DP-92	37	3.7	not possible
WL-DP-124	50	5	not possible
WL-DP-150	62	6.2	not possible
WL-DP-187	75	7.5	not possible
WL-DP-250	100	10	not possible
WL-DP-310	125	12.5	not possible
WL-DP-370	150	15.5	not possible

*) Factory settings

In practise filling times lie between 1:30 mins. und 4:30 mins. (depending on device capacity).

Brining is described in more detail in the following chapter.

4.5 Brine

The capacity of a WaterLine softener device is not a constant but is determined by the following factors:

- Raw water quality (drinking water quality required)
- Raw water hardness
- Raw water hardness variations (require regular checks)
- Raw water flow pressure
- Resin quality
- Resin volume
- Method of brining

These influencing variables must be considered when programming the control valven. Below, particular attention is directed on the method of brining.

Depending on the amount of NaCl consumed during regeneration, full or partial brining is referred to. For a residual hardness of soft water below 0.1 °dH, only full brining is adequate. Full brining requires the use of 220g of salt per liter of resin.



Please note: When working with zero hardness water, zinc-coated pipes must not be used. Only pipes made from plastic or stainless steel are adequate.

In case of a lower requirement concerning the residual hardness, partial brining (i.e. 160g of salt per liter of resin) is allowable.



Please note: When using partial brining, a certain „slip of hardness“ may occur, i.e. following a regeneration soft water hardness may be increased by 2°dH (with respect to the set value) for a certain amount of time.

5. Installation

5.1 Basic prerequisites for operating the Water-Line softener device

The following requirements must be met for operating the Water-Line softener device:

- Electrical connection requires on-site fusing and must not be interrupted at any time (connection to branch circuit not permissible)
- Minimum flow pressure must be 2.5 bar
- Maximum flow pressure must not exceed 7.0 bar. Optimum is 4.0 bar
- Temperature in operating room must be between 5 °C and 40 °C
- R.h. in operating room must not exceed 60 percent
- The drain provided by customer must be a free outlet according to EN DIN 1717
- The operating room must be sufficiently ventilated, must allow for the floor loading introduced by the WaterLine softener device and feature a floor gully.

5.2 Selecting the correct installation location of the Waterline softener device within the plumber installation scenario

- If no mounting block is used, the house installation tubing must be cut at a suitable spot (downstream of the pressure reducer, if applicable) and the Waterline softener device must be inserted
- For insertion of a mounting block approx. 300 mm of free tubing is required
- Should a water filter not be installed yet, another 300 to 400 mm of free tubing for installation of a filter must be considered

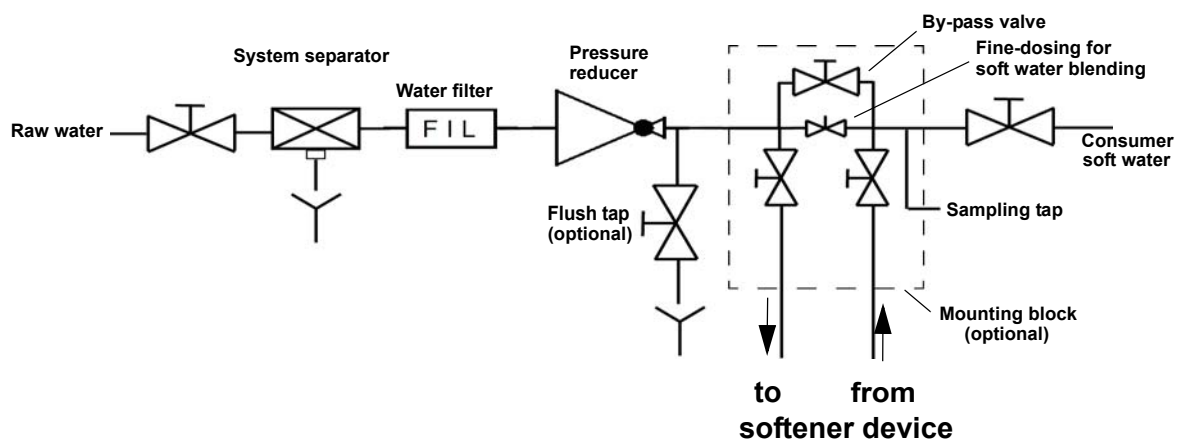

Principle connection of HygroMatik WaterLine WL-C-18 softener device by means of the optional mounting block

5.3 Requirements on the installation site of the WaterLine softener device

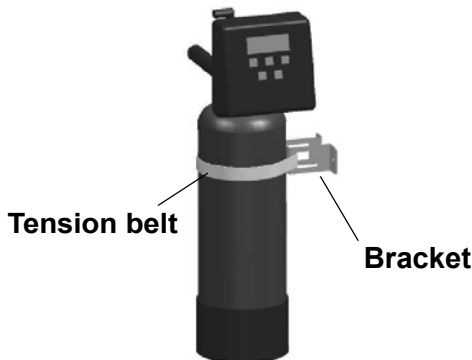

Securing the WaterLine softener device by means of the optionally available wall attachment set

- The floor must be even and dry and have a load capacity that reflects the operating weight of the softener device as given in the technical specifications. An even floor is mandatory in order to allow for a tensionless arranging of the tubing for the device
- The WaterLine softener device must be levelled on-site. For securing the system against tilting by inadvertant impacting, a wall mounting set is available as an option (Article no. B-5000105)
- The floor must be clean and free of pointed objects, stones, construction waste etc. in order not to pose any damaging hazard to the brine tank.
- If required set-up a fundament
- A sewer junction must be in close proximity
- For safety reasons the installation location should feature a floor gully. If no gully exists, a water stop may alternatively be used.

5.4 Set-up of the WaterLine pendulum devices WL-D/DP



Tubing of WL-D/DP

The HygroMatik softener devices WL-D and W-DP are only partially preconfigured when delivered. For transportation safety reasons the second pressure tank is separatly packed. Before operating the system, the tubing between the corresponding connections on the control valve on top of the one pressure tank and the connecting head on the other pressure tank must be put in place. The connecting tube coupling nuts must only be secured hand-tight.

5.5 Attaching the tubing for raw water and soft water

5.5.1 Prerequisites for the correct connection of the tubing on the softener device

- Raw water flow pressure must be 2.5 bar minimum. If not the case, proper functioning of the WaterLine softener device may be impaired by air cushions that may built up. For monitoring flow pressure, it makes sense to integrate a manometer into to the raw water pipe, if not already present.
- Any installations (such as elbows etc.) upstream of the softener device that may reduce flow pressure are not allowable
- Max. flow pressure must never exceed 7.0 bar. If a pressure situation, pressure peaks or hydraulic shocks beyond 7.0 bar may be encountered, a pressure reducer must be implemented upstream of the softener device.

- Raw water supply must always be secured by use of a system separator according to EN DIN 1717
- A filter in the raw water pipe is indispensable in order to prevent foreign matter to be washed into the control valve possibly causing malfunctioning
- A rinsing valve just shortly upstream of the softener is recommended. Rinsing the pipe after installing armatures prevents debris such as pieces of kindling or impermeable material to enter the WaterLine softener device
- On-site tubings must be supported by adequate means in order to avoid tensions in the tubing system
- We recommend the use of pipes made from plastic or stainless steel. Zinc-plated pipes are not suitable for use with zero hardness water.

5.5.2 Connecting the control valve to the house water installation

- » Use adequate hoses incl. flat gaskets to connect water inlet and water outlet of the control valve to the house water installation. Make sure to pay attention to the flow direction arrows on the control valve indicating water inlet and water outlet
- » Check all connections for leakiness

For connecting, the optionally available „Water connection set comprising 2 hoses and titration kit, art. no. B-5000103“ may be used.

WL-S control valve, connections for water, waste water and brine

Waste water connection

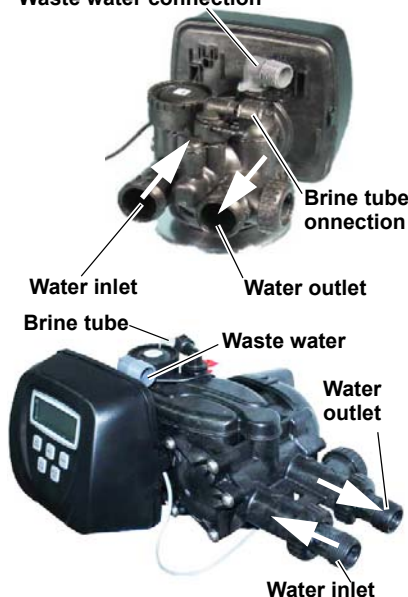

WL-D/DP control valve, connections for water, waste water and brine

5.5.3 Connecting the control valve to the optional mounting block

After installation of the optionally available mounting block (Article no. E-5000072), all valves (i.e. water inlet, water outlet and the by-pass valve) must initially be closed. The set screw for blending fine-dosing must be screwed in fully clockwise (blending valve closed).

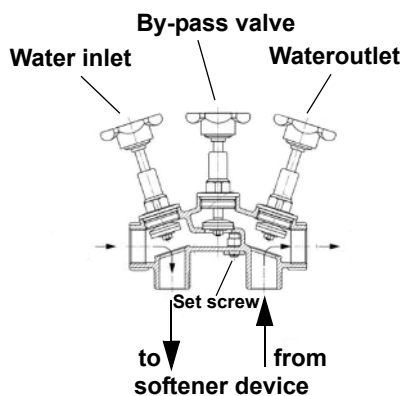

Normal operation of optional mounting block

- » Use adequate hoses incl. flat gaskets to connect water inlet and water outlet of the control valve to the house water installation. Make sure to pay attention to the flow direction arrows on the control valve indicating water inlet and water outlet
- » Open water inlet valve on mounting block. Now drinking water is fed to the softener device via the mounting block
- » Check all connections for leakiness



Please note: The water outlet valve of the mounting block must not be opened prior to start-up of the softener system in order not to allow any water from the softener to enter the house installation before clean soft water is produced (the figure on the left side shows normal operation valve settings).

5.6 Connecting of brine tube

The brine tank comes with a brine tube already connected on one side. The free ending of the brine tube is to be connected to the corresponding control valve connection.



- » Insert brine tube into quick connector (please see the photo on the left) on control valve



Please note: Keep brine tube as short as possible.



Please note: In case of the optional chlorine cell to be used, the t-piece delivered with the cell must be implemented in the brine tube for adaptation of the electrodes. For details, see the according chapter of this manual.

5.7 Make waste water connection

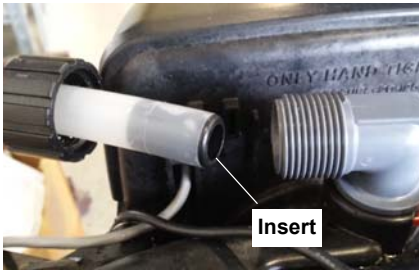

- » Disconnect connecting nut from control valve waste water elbow and push onto PVC waste water hose provided with the system. The hose end holds an insert for stabilizing purposes.
- » Insert waste water hose into waste water elbow on control valve and screw-on connecting nut hand-tight
- » Attach waste water hose with free outlet in order to prevent microbial contamination hazard
- » lay hose without cross-section reduction or kinks

The optionally available waste water connection set (article no. E-5000040) may be used for connection.



Please note: Hazard of backflow! Make sure that the waste water sees a permanent decline when routed to the drain. In case of a drain situated higher than the control valve the use of a backflow flap is a must.

5.8 Connecting the brine tank overflow

A brine tank overflow hose is not provided with the WaterLine softener device. A proper hose must be provided by the customer. The hose provided for waste water draining may be cut in two and the second hose piece may be used for overflow connection.

As is the case with waste water, overflow also needs a free outlet.

6. Start-up



Warning: The system may only be started-up by qualified staff.

- » Close shut-off valve(s) of soft water outlet
- » Make fused mains connection close to installation location
- » Be aware that electrical connection must not be interrupted at any time (do not use branch circuits intended for lighting)



Warning: Do not yet fill any salt into the brine tank. This may only be made after start-up, since otherwise water level in the brine tank cannot be set correctly.



Warning: In order not to allow any (possibly contaminated) water from the softener device enter the house water installation before the first forced regeneration was run, the shut-off valve towards house installation must be initially kept closed. In a next step, forced regeneration should be carried out in order to drain the water fed through the softener device directly to the canal.

6.1 Operating the control valve for the first time

Following the plugging-in of the power adapter, the time of day display on the control valve will flash. Before executing any other steps the system clock may be set.

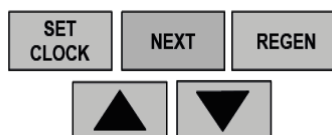
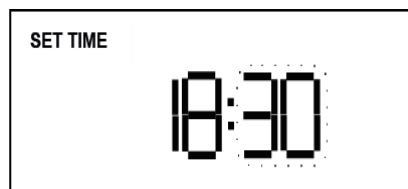
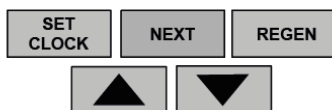
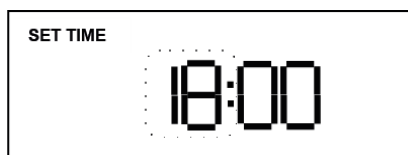

Setting the clock

- » Press the *SET CLOCK* key („SET TIME“ will be displayed and the hour digits will flash)
- » Change the value shown using the Δ and ∇ arrow keys
- » Press the *NEXT* key for saving and advancing to minutes' input (digits will flash)
- » Change the value shown using the Δ and ∇ arrow keys
- » Press the *SET CLOCK* key again in order to finish clock setting; when done so, the display will show „TIME“

6.2 Run forced regeneration

Before using the WaterLine softener device for the first time, a rinse and regeneration process of approx. 40 mins. of duration should be carried out for the a.m. reason. During this period some noise will be perceived due to the motorized valve piston movement and water flowing through the control valve and the tubing.

- » Fill approx. 5 liters of water in the brine tank



Please note: This step is mandatory in order to ensure that the water level exceeds the grid plate allowing the salt tablets to make contact with water when filled into the brine tank after forced regeneration.

- » Open raw water supply to the softener device
- » Press and hold the *REGEN* key on the control valve for 3 secs. in order to start forced regeneration

During regeneration process execution, the current state is indicated by displaying the denomination of the individual step performed in that instant. The whole cycle is through when the display shows „Time“ again and the digits reflect time-of-the-day.

- » Visual inspection: Check all pipes, tubes and hoses for leakiness

At the end of the regeneration process, the control valve triggers the filling a few liters of water into the brine tank required for generation of the brine to be used by the next regeneration.

6.3 Filling the brine tank with salt tablets

- » Fill-up the brine tank with salt tablets at least to a level that makes the water in the tank fully disappear (filling-up to the max. capacity of the tank is harmless).



Please note: The salt needs min. 6 hours for dissolving. Only tablet salt complying with EN 973 should be used.

6.4 Programming the control valve



Please note: The WaterLine softener device was provided with the parameters specific for the system (e.g. the exchanger resin capacity) during the manufacturing process already. Beyond that, some inputs on local influencing values are required from the system operator. Among these are local water hardness and the defined time point of regeneration.



Please note: Programming steps beyond the scope given below are described in chapter 7 (programming of the control valve).



Activation of input mode

- » Press and hold the *NEXT* and Δ keys simultaneously for 5 seconds. The display will show the raw water hardness set by factory

Input of local water hardness

- » Use the Δ and ∇ arrow keys for setting the actual raw water hardness or leave the setting unchanged, if appropriate
- » Press the *NEXT* key for saving and preparing the input of the next parameter (mixed water hardness, „hardness 2“)

Setting mixed water hardness

The control valve features an integrated blending valve, the use of which, however, is not recommended by HygroMatik. Instead, an external blending valve (see chapter 6.5) should be employed. If so, mixed water hardness must be set to „zero“ on the control valve.

- » Set hardness2 to zero by means of the arrow keys
- » Press the *NEXT* key for saving and preparing the input of the next parameter (forced regeneration)

Additional information on the use of the integrated or of an external blending valve

Since the blending valve integrated in the control valve works not very precisely when used with a low flow rate, HygroMatik generally recommends the use of an external blending armature that works independent from pressure. When such a valve is in use, setting the mixed water hardness to „zero“ is mandatory for correct determination of the residual capacity by the control valve.

Should the operator nevertheless decide to use the integrated blending valve, the hardness resulting from blending (and as measured with the help of a hardness measurement kit) must be programmed into the control valve. This value is not an actuating variable for the blending valve but serves solely for the residual capacity determination in combination with other available data. The hardness measurement kit (titration kit) is part of the optionally from HygroMatik available water connection kit.

Setting forced regeneration in [days]

This parameter defines the number of days after which a forced regeneration shall be carried out. Factory setting is „3 days“.

When pressing the *NEXT* after the step prior to the current one, setting the forced regeneration parameter is enabled:

- » Use the Δ and ∇ arrow keys for setting the days or leave the setting unchanged, if appropriate
- » Press the *NEXT* key for saving and preparing the input of the next parameter (forced regeneration time of day setting)

Setting time of the day for forced regeneration

Factory setting for forced regeneration time is 2.00 a.m.- a time of day when typically no demand for water by a consumer exists. When pressing the *NEXT* key in the step prior to the current one, input of time of day was enabled:

- » Use the Δ and ∇ arrow keys for setting the time of day or leave the setting unchanged, if appropriate
- » Press the *NEXT* key for saving and exiting input mode

Finalizing programming

By pressing the *NEXT* key in the step described above, programming of the control valve was finished and the display returned to normal „Time“ mode.

Changing the factory settings of further parameters

Settings beyond the basic settings described here may be made by service personnel. For that purpose, a dedicated programming manual is available from Hygromatik.

6.5 Setting of the optional external blending-valve



Please note: When using the optionally available external mounting block (Mounting block with integrated blending valve, art. no. E-5000072), pls follow the recommendations given in the operating instructions leaflet provided with the article.



Please note: For operating HygroMatik steam humidifiers, a mixed water hardness of 4 to 6 °dH is recommended for electrode humidifiers. For operating heater humidifiers pls. contact HygroMatik first.

In case of an inverted osmosis device downstream of a Water-Line ion exchange softener, zero-degree soft water is required. Such, no raw water is blended to the soft water.

6.6 Finalizing start-up

After completion of the steps delineated in the chapters prior to this, the WaterLine softener device is ready for service. In order to allow soft water flow in direction of the consumer, the water outlet valve on the mounting block (or the armature used) must be opened now.

7. Programming of the control valve

7.1 General information



Please note: If the control valve was cut from mains for a longer period of time, a delay of approx. 30 secs. may occur before the control piston is driven to its home position. The display will flash the time of day format as a request for the time to be set.

7.2 Operating the control valve

Programming and display selection is made by use of the 5 control panel keys (*SET CLOCK*, *NEXT*, *REGEN*, Δ and ∇). When in normal operation, the softener device display shows time of the day.

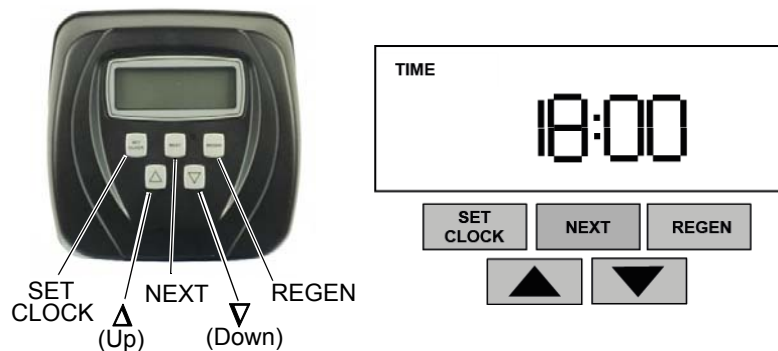

Please note: Any input or display step invoked by pressing the *NEXT* key may be cancelled by pressing the *REGEN* key without any other effect. Finishing an input step within a particular programming level will automatically make the control proceed to the next step in the order documented here.



Please note: Should the control valve refrain from reacting to inputs of any kind, the valve lock may be active.

7.2.1 Deactivating and re-activation of the valve lock

In order to prevent any unintended parameter setting, a valve lock may be activated.

Disengage valve lock

» Sequentially press the ∇ , *NEXT*, Δ and *SET CLOCK* keys. Display will show „DISPLAY UNLOC“

Engage valve lock

For re-engaging the valve lock, exactly repeat the step described above. Display will show „DISPLAY LOC“

7.2.2 Initiation of an exchange of the tank in service

This is only relevant for WaterLine WL-D/DP softener devices.

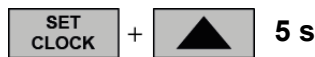

» Press and hold the *SET CLOCK* - and Δ - keys simultaneously for approx. 5 secs

The motorized alternator valve will then audibly be positioned. This step may be arbitrarily repeated. After a tank switch, days remaining and capacity remaining status is retained for each tank until the next regeneration.



Please note: The tank in service is not indicated in the display. However, differentiation is made when the current volume flow (see section 1.5) is displayed. Exchanging the tanks may be directly initiated on that level.

7.3 Basic Programming Structure

Programming and device status evaluation is generally accomplished on 4 distinct levels:

- Level 1: Operator displays and settings
- Level 2: Installer displays and settings
- Level 3: Diagnostics
- Level 4: Control valve history

7.4 Overview on the display and operating options for the device operator (Level 1, normal operation)

Starting with the time of day display, on this level the user may only change the time setting, view the current water flow and the remaining capacity, or initiate manual regeneration at the time set or immediately.

In normal operation the display shows „TIME“ and the time of the day. Using the *NEXT* key allows for scrolling through all of the other views.

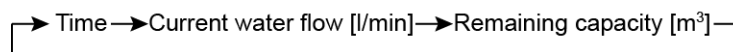

Use *NEXT* key

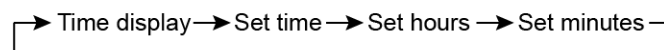

Use *SET CLOCK / UP / DOWN / NEXT / SET CLOCK* keys

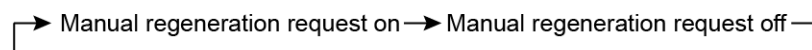

Use *REGEN* key (press and hold for 3 s for immediate execution)

7.5 Control valve programming steps

7.5.1 Set time of the day

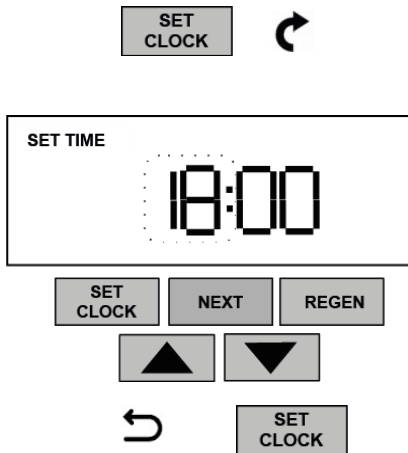

- » Press the *SET CLOCK* key („SET TIME“ is displayed and the hour field flashes)
- » Change the setting using the Δ and ∇ arrow keys
- » Press the *NEXT* key for storage and to advance to the minutes setting (minutes field flashing)
- » Change the setting using the Δ and ∇ arrow keys
- » Press the *SET CLOCK* key again for storage and exiting time of day setting; the display returns to „TIME“

7.5.2 Display of current water flow and remaining capacity

View current water flow

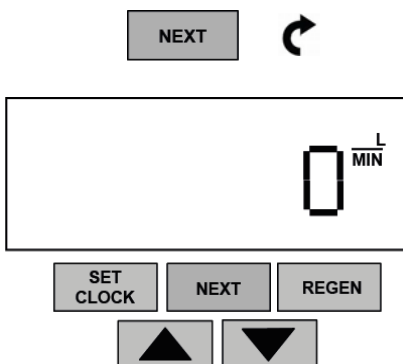

- » Starting from „TIME“ display press the *NEXT* key; the current water flow in l/min is displayed
- » Press the *NEXT* key for the next step or *REGEN* to return to the previous display, i.e. time of day



Please note: In case of WL-D/DP softener devices, the display will indicate the tank in service with „A“ referring to the tank the control valve is attached to, and „b“ to the other one.

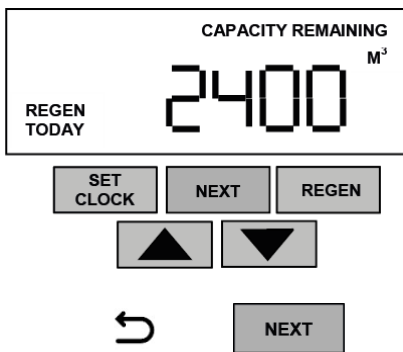

View remaining capacity (available amount of treated water)

- » When pressing the *NEXT* key to finalize the previous step the display shows „CAPACITY REMAINING“ and the amount of softened water in [M³] is displayed
- » Press the *NEXT* key for returning to the time of day display or *REGEN* to go back to the previous step

7.5.3 Triggering an ahead-of-schedule regeneration on reaching the time set for the first time

This action will be executed independently from the remaining capacity



- » Press the *REGEN* key; the display will flash „REGEN TODAY“ as an indication for the „waiting“ regeneration cycle
- » Pressing *REGEN* again cancels the requested action

7.5.4 Triggering an instantaneous regeneration cycle



- » Press and hold the *REGEN* key for about 5 secs; control will position the valve piston for execution of the first cycle defined. The display will show „REGEN“ and the corresponding cycle number (starting with the first cycle) and the cycle denomination. Additionally, the set cycle duration will be displayed and decreased as the cycle is executed

At the start of a cycle the display flashes for a few seconds. Subsequently, the cycle denomination and its duration are displayed. On completion of a particular cycle the next cycle defined is automatically invoked. When the last cycle is done the control valve will return to **normal operation** with the display showing time of day information.



Please note: All cycles may be exited at any time by pressing the *REGEN* key. Subsequently, the next cycle in the programmed order will commence.

8. Maintenance

8.1 General information

The HygroMatik softener device requires only very little maintenance by design. In order to guarantee the water quality desired, however, periodically performed checks of the device are important. Daily control of proper operation is just one activity to start with. Beyond that, an extended life-time of the HygroMatik WaterLine softener device may only be achieved when programmed maintenance is carried out.

With respect to standards and regulations relevant for drinking water supplies, we recommend that the following intervals are met:

- bimonthly inspection of the device by the device operator
- minor maintenance every 6 months by the device operator
- full maintenance once per year by the supplier or a plumbing company.



Warning: When carrying out maintenance works pls. keep in mind:

- only expert staff may do the maintaining
- always obey security regulations
- Prior to maintenance work shut-down operation of device and secure system against switching on (pull power adaptor)
- After finishing maintenance work, have device checked for operational safety by expert personnel

8.2 Maintenance work to be carried out by the device operator

8.2.1 Daily check of proper device operation



Visual inspection

Check device for leakiness. Leaking components should be made tight by technical staff. No kinks are allowed in feeding or draining hoses.

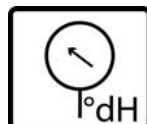

Check raw water hardness

In case of a deviation from set value, settings may be required to be changed by technical staff.

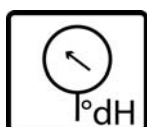

Check soft water hardness

In case of a deviation from set value, settings may be required to be changed by technical staff.



Check salt tablet supply

A certain amount of salt must always be detectable in the brine tank in order to ensure the availability of the 25 percent brine required for the regeneration of the exchanger resin. The latest instance for filling up the salt tablet supply is when the liquid level exceeds the salt level.

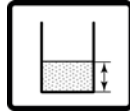

Refill salt

It is recommended to refill salt tablets up to the lower rim of the feed opening when the amount of salt consumed corresponds to approx. one quart of the total tank volume.



Attention! Make sure not to introduce any contamination into the brine tank since this may impair water quality. When refilling salt, hygienically flawless proceeding must always be ensured.



Please note. For **hygienic** reasons the following precautionary measures must be taken:

- Store the regeneration salt exclusively in a dry and clean place
- Preferably, do not use open packages or bags
- Clean the package or bag outside before opening it
- Fill the brine tank only directly with salt from the package or bag
- Under all circumstances, close the brine tank carefully with the cap provided for this purpose!



Please note: In case of a regeneration cycle without the adequate brine concentration (i.e. 25 percent), one more regeneration cycle is required for single softener devices after the 6 hours of wait time for the salt tablets to dissolve. Double softeners require two regeneration cycles because of the two pressure tanks.

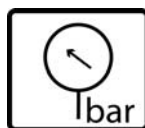

Check operating pressure of the softener device

Flow pressure must lie within specified tolerance (see technical specifications).

8.2.2 Bimonthly inspection



- Check leakiness of wastewater connection on control valve**

No wastewater to be detected on connection elbow



- Check filter insert of fine filter in raw water pipe and replace if contaminated or visible wear detectable**

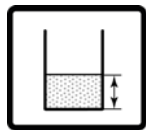

- Check brine consumption during regeneration as indicated by salt filling level change in brine tank.**

Unsufficient salt consumption may indicate that brine sucking is disordered. In this case the injector and injector screen cage must be cleaned (see chapter „Minor maintenance“). Also, check brine tube for leakiness.

8.2.3 Minor Maintenance (every 6 months)



- Exchange filter insert in raw water fine filter**

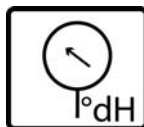

- Determine raw water and soft water hardness**

Use water hardness kit.



- Check time-of-day and raw water setting on control valve**

In case of a deviation of more than 1°dH between the raw water value measured and the value set, the control valve setting must be corrected.



- Clean injector and injector screen cage**

For these works the injector cap(1) on he control valve must be dismantled. Use the service spanner wrench (6) provided with the device to loosen the screw connection

- » Dismount injector cap (1) on control valve
- » Remove and clean injector (5)
- » Remove and clean injector screen cage (3)
- » Reinsert screen cage and injector and refit injector can (hand-tight only)

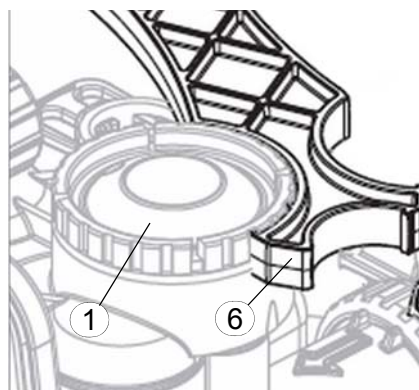
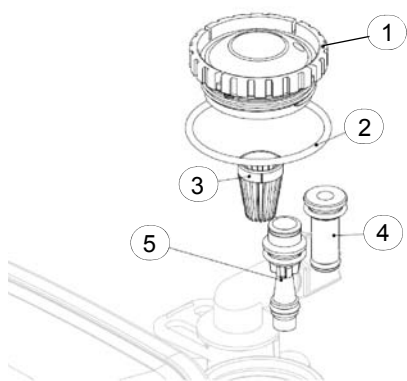

- 1 - Injector cap
- 2 - O - ring
- 3 - Injector screen cage
- 4 - Injector assembly Z plug
- 5 - Injector
- 6 - Service spanner wrench



Check leakiness of complete device (including drain)

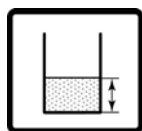

Check salt tablet supply in brine tank und fill up, if required (s. chapter. 8.2.1)



Check salt consistency in brine tank

The salt must not be agglutinated (if required, break up clumping with an appropriate tool or dissolve using hot water)



Check leakiness of brine tube and replace, if required

8.3 Full maintenance

With respect to EN 1717 (was: DIN 1988 part 8/A12) a complete maintenance program should be carried out once per year by expert staff or the softener device supplier. The maintenance procedure for the annual maintenance effort is described in a document of its own that may be received from HygroMatik upon request.

8.4 Troubleshooting

Problem	Possible cause	Solution
Device not lively	Mains disruption	Check whether power adapter is plugged in; check fusing; make sure that mains connection is disruption-free
Water remains hard	By-pass valve open	Close by-pass valve until desired blended hardness is accomplished
	No salt in brine tank	Fill-in salt
	Injector contaminated	Clean injector and screen cage
Salt consumption too high	Brine FILL parameter wrongly set	Correct FILL programming Contact expert company for drinking water treatment
Loss of capacity	Salt type inadequate	Only use approved pure salt
	Raw water hardness has changed	Check raw water hardness and correct control valve setting, if required
	Brine concentration too low	Allow salt to dissolve for at least 6 hours before start of regeneration
Water is drained during softening	Control valve piston not in operating position	Check control valve; press NEXT and REGEN keys simultaneously for 3 seconds to reset control valve
General error code on control valve	Control valve not properly functioning	Check control valve; press NEXT and REGEN keys simultaneously for 3 seconds to reset control valve (call expert for interpretation of error code)

9. Removal from service, storage and recommissioning

9.1 Removal from service



Please note: Even when the device is not used for longer periods of time, it should remain switched-on since hygienic regenerations are run in stand-by as well.

Should for good cause removal from service nevertheless be required, the steps below must be performed.

Work is comprehensive and should only be carried out exclusively by an expert company for drinking water treatment.

- » For a last operational cycle, run resin regeneration
- » Completely remove resin from pressure tank
- » Wash pressure tank with water and let dry
- » Flush pipes and hoses with water and let dry
- » Clean control valve with water and let dry
- » Empty brine tank, flush and let dry
- » Let dry remaining salt and, subsequently, store in a dry place

9.2 Storage

- » Store resin in moist condition, protect against drying-up
- » Store resin frost-free
- » Store salt inventory and remaining salt from brine tank in a dry place
- » Keep pressure tank(s) away from sun in order to prevent aging
- » Store pressure tank(s) shock-proof
- » Store control valve and power adapter in a dry place
- » Retain small components within clean and dry brine tank
- » Keep a copy of this operating manual close to the device

9.3 Recommissioning

Recommissioning is carried out in the same way as initial start-up was.

This page intentionally left blank

10. Optional chlorine cell

10.1 Functional description and design

For bacteriostatic purposes the chlorine cell produces active chlorine by electrolysis during the brining process. The chlorine makes contact with the ion exchanger resin and, consequently, sports a bactericidal effect. Chlorination is only effective during brine intake and stops automatically when slow wash or rinse is started. Any excessive chlorine in the resin bed is washed out after regeneration.

The system is composed from the following assemblies:

- T-shape electrode bracket with brine tube inlet and brine tube outlet
- Control device
- Electrode cable with titan electrodes and connectors for control device connection
- Power adapter

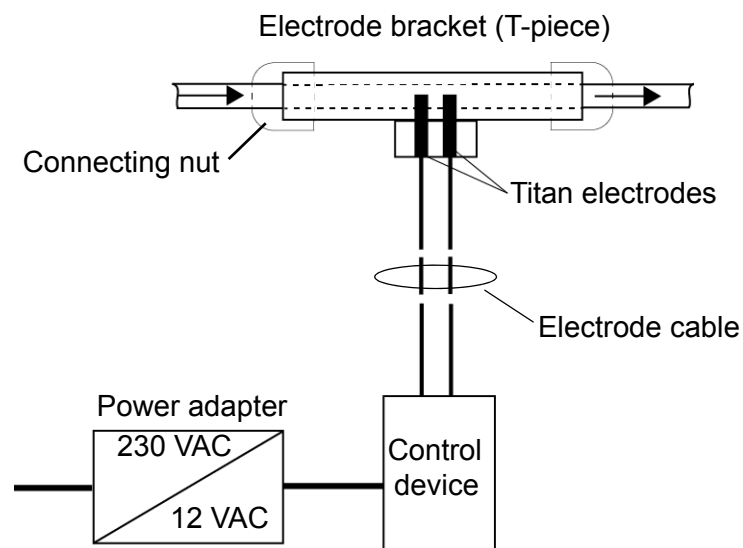

10.2 Mounting the device

- » Cut the brine tube at a suitable position
- » Unscrew the two connecting nuts from the electrode bracket and push them onto the two brine tube endings that result from cutting
- » Insert the tube endings into the electrode bracket inlet and the electrode bracket outlet. Screw on the connecting nuts while using teflon tape for sealing
- » Plug the electrode end of the electrode cable into the electrode bracket

- » Attach the control device to a wall or a suitable mount. A mains socket 230VAC/50 Hz is required in the nearby
- » Connect the other end of the electrode cable to the control device

10.3 Setting-up the control device

On the front panel of the control device a 4-step set screw allows for the adaptation of the chlorination extent to the resin volume used.

The information given in the table below may only be regarded as guide values:

Set screw position	0	2	4	6
max. resin volume [l]	50	100	200	300

In case of raw water hardness beyond 30 °dH setting „4“ or „6“ should be used.

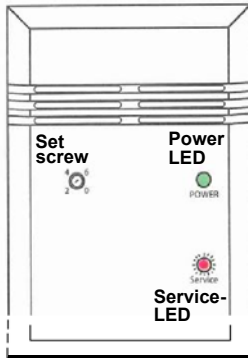

Control device

10.4 Operating

Operating is started when the power adapter is plugged into the mains socket. The system is then in stand-by. The green power LED is on as long as the mains connection is not disrupted.

Three operating cycles may be distinguished (see table below) In case of a break of mains supply the current cycle will terminate.

Operating cycle	Function	Service LED state
Stand-by	Conductivity is monitored	lights up every 30 secs
Service chlorination	Resin bed is disinfected	permanently on
Service blocked	Disinfection terminated. No further disinfection within the next 120 mins.	continuously flashes for 120 mins

10.5 Chlorine cell maintenance

The electrode bracket should be disassembled approx. every 6 months and be rinsed with warm water. Any visible salt deposit must be removed.

10.6 Technical specifications

Control device

Input voltage: 12 VAC

Output voltage: 2 - 6 VDC, 350 mA

Protection class: IP41

Power adapter

Input voltage: 230 VAC

Output voltage: 12 VAC

Protection class: IP 54

Conformity: EC 23/73 and EC 336/89

10. Technical specifications

Unit type	WL-S-20	WL-S-40	WL-S-60	WL-S-80	WL-D-20	WL-D-40	WL-D-60	WL-D-80
Device specification								
Capacity	20	40	60	80	2 x 20	2 x 40	2 x 60	2 x 80
	$\frac{\text{m}^3 \times \text{dH}}{\text{m}^3 \times 17.8 \text{ ppm}}$							
Minimum flowrate	300	400	600	800	300	400	600	800
Corresponding soft water output @ 10 °dH	60	60	60	60	60	60	60	60
Resin volume	2000	4000	6000	8000	2x 2000	2 x 4000	2 x 6000	2 x 8000
Required amount of salt (NaCl) per regeneration								
Full brining	5	10	15	20	2 x 5	2 x 10	2 x 15	2 x 20
Partial brining	1,1	2,2	3,3	4,4	1,1	2,2	3,3	4,4
Regeneration salt amount required per liter of resin	0,8	1,6	2,4	3,2	0,8	1,6	2,4	3,6
Full brining		0,22				0,22		
Partial brining		0,16				0,16		
Water consumption per regeneration	50	100	150	200	50	100	150	200
Dimensions, weight and class								
Operational weight	110	125	135	145	125	140	150	160
Weight of device	24	29	33	38	40	47	55	63
Protection class		54				54		
Connections								
Electrical connection			230/50/50				230/50/50	
Min. raw water flow pressure			2,5				2,5	
Max. raw water flow pressure			7				7	
Min. raw water temperature			5				5	
Max. raw water temperature			30				30	
Raw water inlet connection			1				1	
Soft water outlet connection			1				1	
Min. drain diameter			1/2				1/2	
Installation location requirements								
Max. environmental temperature			40				40	
Max. relative humidity			60				60	
Approx. Depth			500		500		700	
Approx. width		600		700		1100		1200
Approx. height	770	950	1100	1200				

Unit type	WL-D-100	WL-D-160	WL-D-200	WL-D-240	WL-D-300	WL-D-400	WL-D-500	WL-DP-30
Device specification								
Capacity	2 x 100 1000	2 x 160 1600	2 x 200 2000	2 x 240 2400	2 x 300 3000	2 x 400 4000	2 x 500 5000	2 x 30 850
Minimum flowrate	60	60	60	60	60	60	60	60
Corresponding soft water output @ 10 °dH	2 x 10000	2 x 16000	2 x 20000	2 x 24000	2 x 30000	2 x 40000	2 x 50000	2 x 3000
Resin volume	2 x 25	2 x 40	2 x 50	2 x 60	2 x 75	2 x 100	2 x 125	2 x 12
Required amount of salt (NaCl) per regeneration								
Full brining	5,5	8,8	11	13,2	16,5	22	27	1,2
Partial brining	4	6,4	8	9,6	12	16	20	n/a
Regeneration salt amount required per liter of resin								
Full brining				0,22				0,1
Partial brining				0,16				n/a
Water consumption per regeneration	250	400	500	600	750	1000	1200	120
Dimensions, weight and class								
Operational weight	180	250	280	330	470	570	670	160
Weight of device	73	109	128	151	177	229	279	55
Protection class				54				54
Connections								
Electrical connection				230/50/50				230/50/50
Min. raw water flow pressure				2,5				2,5
Max. raw water flow pressure				7				7
Min. raw water temperature				5				5
Max. raw water temperature				30				30
Raw water inlet connection				1				1
Soft water outlet connection				1				1
Min. drain diameter				1/2				1/2
Installation location requirements								
Max. environmental temperature				40				40
Max. relative humidity				60				60
Approx. Depth	700	850	850	850	1000	1000	1000	700
Approx. width	1100	1200	1200	1300	1700	1700	1900	1200
Approx. height				1700			2000	1200

Unit type	WL-DP-62	WL-DP-92	WL-DP-124	WL-DP-150	WL-DP-187	WL-DP-250	WL-DP-310	WL-DP-370
Device specification								
Capacity	2 x 62	2 x 92	2 x 124	2 x 150	2 x 187	2 x 250	2 x 310	2 x 370
	$m^3 \times \text{dH} /$ $m^3 \times 17.8 \text{ ppm}$							
Minimum flowrate	1000	1300	1900	2200	2400	3400	4600	6000
	l/h	l/h	l/h	l/h	l/h	l/h	l/h	l/h
Corresponding soft water output @ 10 °dH	2 x 6200	2 x 9200	2 x 12400	2 x 15000	2 x 18700	2 x 25000	2 x 31000	2 x 37000
Resin volume	2 x 25	2 x 37	2 x 50	2 x 62	2 x 75	2 x 100	2 x 125	2 x 150
Required amount of salt (NaCl) per regeneration								
Full brining	2,5	3,7	5	6,2	7,5	10	14,5	15
Partial brining				n/a				
Regeneration salt amount required per liter of resin								
Full brining				0,1				
Partial brining				n/a				
Water consumption per regeneration	250	370	500	620	750	1000	1200	1500
	l	l	l	l	l	l	l	l
Dimensions, weight and class								
Operational weight	190	250	320	360	560	660	830	1000
Weight of device	83	113	142	175	210	266	340	414
Protection class				54				
Connections								
Electrical connection				230/50/50				
Min. raw water flow pressure	2,5	2,5	2,5	2,5	2,5	2,5	2,5	2,5
Max. raw water flow pressure	7	7	7	7	7	7	7	7
Min. raw water temperature	5	5	5	5	5	5	5	5
Max. raw water temperature	30	30	30	30	30	30	30	30
Raw water inlet connection	1	1	1	1	1	1	1	1
Soft water outlet connection	1	1	1	1	1	1	1	1
Min. drain diameter	1/2	1/2	1/2	1/2	1/2	1/2	1/2	1/2
	inch	inch	inch	inch	inch	inch	inch	inch
Installation location requirements								
Max. environmental temperature				40				
Max. relative humidity				60				
Approx. Depth		700	850			1000		
Approx. width	1300	1400	1700	1600	2000	2100	2300	2500
Approx. height	1400	1650	1650	1700	1950	1950	2050	2100

This page intentionally left blank

11. Spare parts

Article No.	Description
E-5000046	O-ring 228
E-5000048	WS1 Spacer stack assembly
E-5000050	Injector black
E-5000064	Hose for WaterLine 1" IT, 700 mm, Nut 90°/1", Nut BSP
E-5000118	Control Valve CI complete, including EU-Transformer 230V and
E-5000066	Hardness monitoring unit
E-5000068	Filter housing 1" IT, 9 3/4" - 2,5"
E-5000070	Filter cartridge 100 µm, set of 2 pcs.
E-5000072	Mounting block 1" incl. sampling cock, differential pressure balance and blending valve
E-5000074	Pressure reducer R 1" with manometer
E-5000076	System separator BAR 1" DN25 incl. connection fitting and discharge connection
E-5000086	Service spanner wrench
E-5000088	Free flow valve 1" with drain
E-5000040	Wastewater connection set according to DIN EN 1717
E-5000090	Funnel syphon white DN 50 according to DIN EN 1717
B-5000105	Wall mounting set for WaterLine (WL-S/D/DP only)
When ordering pls. specify type of unit as well	

This page intentionally left blank



HYGROMATIK[®]

Lise-Meitner-Str.3 • D-24558 Henstedt-Ulzburg
Phone +49(0)4193/ 895-0 • Fax -33
eMail hy@hygromatik.de • www.hygromatik.com
A member of the **spirax**/**sarco** Group