

HYGROMATIK®

Nozzle System LPS

Humidifies and Cools



Operating Manual



LPS.EN
E-8881122

Certain computer programs contained in this product [or device] were developed by HygroMatik GmbH ("the Work(s)").

Copyright © HygroMatik GmbH [09.12.2022]

Nozzle System LPS (Low Pressure System)

LPS.EN

All Rights reserved.

HygroMatik GmbH grants the legal user of this product [or device] the right to use the Work(s) solely within the scope of the legitimate operation of the product [or device]. No other right is granted under this licence. In particular and without prejudice to the generality of the foregoing, the Work(s) may not be used, sold, licensed, transferred, copied or reproduced in whole or in part or in any manner or form other than as expressly granted here without the prior written consent of HygroMatik GmbH.

Information in this manual is subject to change or alteration without prior notice.

▲ WARNING**Risk of electrical shock!**

Hazardous electrical high voltage!

All electrical work to be performed by certified expert staff (electricians or expert personnel with equivalent training) only.

1. Introduction	6
1.1 Typographic Distinctions	6
1.2 Documentation	6
1.3 Symbols in Use	6
1.3.1 Specific Symbols related to Safety Instructions	6
1.3.2 General Symbols	7
1.4 Intended Use	7
2. Safety Instructions	8
2.1 Guidelines for Safe Operation	8
2.1.1 Scope	8
2.1.2 Unit control	8
2.1.3 Unit Operation	8
2.1.4 Mounting, dismantling, maintenance and repair of the unit	9
2.1.5 Electrical	9
2.2 Disposal after dismantling	9
3. Transport	10
3.1 General information	10
3.2 Packaging	10
3.3 Interim storage	10
3.4 Check for Complete and Correct Delivery of Goods	10
3.5 Scope of delivery	10
4. Composition and function of the nozzle system	11
4.1 Fields of application	11
4.2 Functioning	11
4.3 Schematic diagram of the system components	11
4.4 Control options (modes of operation)	12
4.4.1 Supply air humidification (standard operation)	12
4.4.2 Supply air humidification 2 load mode (normal requirements; comfort humidification) ..	12
4.4.3 Supply air humidification 3 load mode (process humidification)	12
4.4.4 Exhaust air cooling	12
4.4.5 Combined system	13
4.4.5.1 Pump station	13
4.5 Main components	14
4.5.1 The system cabinet and its installations	14
4.5.1.1 Electrical, electromechanical and electronical components	15
4.5.2 Vortex modules	15
4.5.2.1 Atomising nozzles for vortex modules	16
4.5.3 Aerosol separators	16
4.5.4 Humidification section	16
4.6 Flushing functions	17
5. Humidification chamber	18
5.1 Structural composition of a humidification chamber	18
5.2 Mechanical assembly Vortex wall	19

6. Mechanical installation	20
6.1 Environment Parameters to be met and Mounting Recommendations	20
6.2 Unit installation	20
6.3 Unit dimensions	22
6.4 Unit connections	22
6.5 Hydraulic wiring diagram	23
7. Supply and waste water connections	24
7.1 Schematic view	24
7.2 Water inlet	25
7.2.1 Supply water quality	25
7.3 Water drain	25
7.3.1 Water drain of the humidification chamber	25
7.4 Water connection final check	26
8. Hygiene	27
8.1 Ensuring hygiene (VDI 6022)	27
8.2 Automatic flushing	27
8.3 Air feed for the nozzle system	27
9. Electrical connection	28
9.1 Electrical installation approach	28
9.2 Main connection	28
9.3 Safety (interlock) system	29
9.4 Inspecting the electrical installation	29
10. Commissioning	30
11. Description of control	32
11.1 General description	32
11.2 Layout of control	32
11.3 Mainboard	33
11.3.1 Mainboard 1	33
11.3.2 Connections on the mainboard	34
11.3.2.1 Customer-side interfaces	34
11.3.2.2 System-side interfaces	34
11.4 Expansion board	35
11.4.1 Exchange / connection of the extension board	35
11.4.2 Connections of the expansion board	36
11.5 Connection terminals block	36
11.6 Electrical connection	37
11.6.1 Connection of control voltage	37
11.6.2 Connection of interlock (safety) system	37
11.6.3 Terminal wiring for the various modes of operation	38
11.6.3.1 Terminal wiring for supply air humidification (standard delivery)	38
11.6.3.2 Terminal wiring for a combined unit (ordering option)	39
12. Control operation	40
12.1 Principal user guidance	40

12.2 Menu structure	40
12.3 Menu tree	41
12.4 The control panel	43
12.5 Navigation within a menu	43
12.6 Tabular representation of reading value list and provider level submenus	44
12.6.1 The reading value list	44
12.6.2 Advanced level submenus and relating parameters	45
12.7 Exemplary variation of a parameter setting	50
12.8 Detailed description of the basic level reading values and settings	51
12.9 Detailed parameter descriptions	55
13. Maintenance	60
13.1 Maintenance activities	60
13.1.1 Checking/replacing the mains water filter	60
13.1.2 Flushing the mains water system	61
13.1.3 Cleaning the nozzles	61
13.1.4 Cleaning the aerosol separators	62
13.1.5 Cleaning the spray system	62
13.1.6 Cleaning the mounting profiles	62
13.1.7 Cleaning the humidification chamber	62
14. Trouble shooting	63
14.1 Error handling	63
14.1.1 Table of possible faults and related error codes	63
15. Declaration of conformity	67
16. Spare parts	68
17. Dimensions	70
18. Technical specifications	71

1. Introduction

Dear Customer,

Thank you for choosing a HygroMatik nozzle system LPS. „LPS“ stands for „Low Pressure System“, i.e. , in question is a nozzle system that is operated with low pressure (5 to 15 bar).

The HygroMatik nozzle system LPS (referred to hereafter as „nozzle system“) represents the latest in humidification technology.

In order to operate the nozzle system safely, properly and efficiently, please read these operating instructions.

Employ your nozzle system only in sound condition and as directed. Consider potential hazards and safety issues and follow all the recommendations in these instructions.

If you have additional questions, please contact your expert dealer.

For all technical questions or spare parts orders, please be prepared to provide unit type and serial number (see name plate on the unit).

1.1 Typographic Distinctions

- Preceded by a bullet: general specifications
- » Preceded by an arrow: procedures for servicing or maintenance which should or must be performed in the indicated order
- ☑ Installation step which must be checked off.

1.2 Documentation

Retention

Please retain these operating instructions in a secure, always accessible location. If the product is resold, turn the documentation over to the new operator. If the documentation is lost, please contact HygroMatik.

Versions in Other Languages

These operating instructions are available in several languages. If interested, please contact HygroMatik or your HygroMatik dealer.

1.3 Symbols in Use

1.3.1 Specific Symbols related to Safety Instructions

According to ANSI Z535.6 the following signal words are used within this document:

▲ DANGER

DANGER indicates a hazardous situation which, if not avoided, will result in death or serious injury.

▲ WARNING

WARNING indicates a hazardous situation which, if not avoided, could result in death or serious injury.

▲ CAUTION

CAUTION indicates a hazardous situation which, if not avoided, could result in minor or moderate injury.

NOTICE

NOTICE is used to address practices not related to physical injury.

1.3.2 General Symbols

Please note

This symbol is used whenever a situation requires special attention beyond the scope of safety instructions.

1.4 Intended Use

The nozzle system is used for air humidification and cooling with desalinated water having a conductivity of 5-50 $\mu\text{S}/\text{cm}$.

Proper use includes fulfilment of the assembly, disassembly, reassembly, start-up, operating and maintenance conditions specified by us as well as disposal measures.

Only qualified and personnel may work on or with the system (a supplementary qualification according to VDI 6022 Part B or an equivalent qualification is recommended). Persons transporting or working on or with the system must have read and understood the relevant parts of this operating manual, particularly the 'Safety instructions' section. Staff must also be informed of possible hazards by the operating company. Please keep a copy of the operating manual at the location where the device is being used.

Applications:

The nozzle system has a wide range of applications. These systems are used wherever low-energy adiabatic humidification or cooling or systems with high-precision control are needed. They can be found in such places as offices, storerooms, production halls, clean rooms, hospitals and concert halls.

NOTICE

Components installed in ventilation and air-conditioning systems must be suitable for the intended use; i.e., according to VDI 6022 or equivalent, they must be corrosion-resistant, easy to clean, accessible and hygienic. Furthermore, they must not facilitate growth of micro-organisms.

Improper use:

Any other use not compatible with the intended use outlined above is not allowable. Improper use as well as changes in hardware or software that are not authorized by HygroMatik will lead to the total loss of guarantee and warranty claims.

NOTICE**Operating conditions must be met at any time!**

- The nozzle system is not frost-proofed and not suitable for outdoor installation
- The room temperature should lie between 5 and 20 °C
- When attempting to operate the system in a position higher than 1000 m above sea level, pls. talk to HygroMatik prior to installation
- The pressure level of the nozzle system must not be changed without the consent of HygroMatik GmbH
- The nozzle system must not be used for cold water cooling without the consent of HygroMatik GmbH
- The nozzle system must not be operated with a vertical flow without the consent of HygroMatik GmbH

Please note

For hygienic reasons (legionella prevention), the feed water temperature should not exceed 15 °C.

2. Safety Instructions

These safety instructions are required by law. They promote workplace safety and accident prevention.

2.1 Guidelines for Safe Operation

2.1.1 Scope

Comply with the accident prevention regulation „DGUV Regulation 3“ to prevent injury to yourself and others. Beyond that, national regulations apply without restrictions.

2.1.2 Unit control

Do not perform any work which compromises the safety of the unit. Obey all safety instructions and warnings present on the unit.

In case of a malfunction or electrical power disruption, switch off the unit immediately and prevent a restart. Repair malfunctions promptly.

▲ WARNING

Restricted use.

IEC 60335-1 stipulates as follows:

This device may be used by children of eight years of age and above as well as by persons with reduced physical, sensory or mental capabilities or lack of experience and knowledge so long as they are supervised or have been instructed regarding the safe use of the device and understand the hazards that may result from it. Cleaning and user maintenance of the unit must not be undertaken by children without supervision.

2.1.3 Unit Operation

▲ WARNING

Health hazard due to the inhalation of aerosols.

During operation of the HygroMatik nozzle system LPS, it is not permitted to stay in the humidifier chamber.

▲ CAUTION

Health hazard

The demineralized water required for the operation of the HygroMatik nozzle system LPS is not suitable for drinking.

NOTICE

Risk of material damage!

The unit may be damaged if switched on repeatedly following a malfunction without prior repair.

Rectify defects immediately!

Regularly check that all safety and monitoring devices are functioning normally. Do not remove or disable safety devices.

2.1.4 Mounting, dismantling, maintenance and repair of the unit

NOTICE

The nozzle system is IP20 protected. Make sure that the unit is not object to dripping water in the mounting location.

- Installing a nozzle system in a room without water discharge requires safety devices that cut-off the water supply in case of leakages.
- The temperature of the unit location should lie between 5 and 20°C (41 and 68 °F).
- Use genuine spare parts only.
- After any repair work, have qualified personnel check the safe operation of the unit.
- Attaching or installing of **additional components** is permitted only with the **written consent** of the manufacturer.

2.1.5 Electrical

▲WARNING

Risk of electrical shock!

Hazardous electrical voltage!

Any work on the electrical system to be performed by certified expert staff (electricians or expert personnel with comparable training) only.

Disconnect unit components from electrical power supply prior to work.

After electrical installation or repair work, test all safety mechanisms (such as grounding resistance).

NOTICE

Use only original fuses with the appropriate amperage rating.

Regularly check the unit's electrical equipment. Promptly repair any damage such as loose connections or burned wiring.

Responsibility for intrinsically safe installation of the HygroMatik steam humidifiers is incumbent on the installing specialist company.

2.2 Disposal after dismantling

NOTICE

The operator is responsible for the disposal of unit components as required by law.

3. Transport

3.1 General information

Please note

Take care when transporting the nozzle to prevent the device and packaging from being damaged by impact or accidental loading or unloading.

3.2 Packaging

The nozzle system is delivered in a box.

3.3 Interim storage

Store the unit in a dry place and protect from frost and strong sunlight.

Please note

Only clean components may be installed in a ventilation duct.

3.4 Check for Complete and Correct Delivery of Goods

Upon receipt of the unit, confirm that:

- model and serial number on the name plate match those specified in the order and delivery documents
- the equipment is complete and all parts are in perfect condition

Please note

In case of damage from shipment and/or missing parts, immediately notify the carrier or supplier in writing.

Time limits for filing freight claims with shipping companies are*:

Shipping company	After receipt of goods
Carriers	no later than 4 days
Parcel service	immediately

* Time limits for some services subject to change.

3.5 Scope of delivery

The following items are included in the delivery:

- spray system
- aerosol separators
- pumpstation with control
- operating instructions for the system.

4. Composition and function of the nozzle system

4.1 Fields of application

Typical application of the nozzle system is the humidification of an supply air stream. As an order option, a particular unit variant is available that is used for exhaust air cooling. An other order option is the „Combined system“ that supports both operation modes. In a combined system, the actual operation is determined by the terminal wiring that usually encompasses a switch for mode selection.

4.2 Functioning

The nozzle system is based on atomisation of water.

Desalinated water is fed into a vane pump. With an operating pressure of up to 15 bar, the water is atomized by means of nozzles. These nozzles generate a very fine spray mist which is taken up by the air in the humidification chamber. The ambient air is cooled adiabatically in the process.

4.3 Schematic diagram of the system components

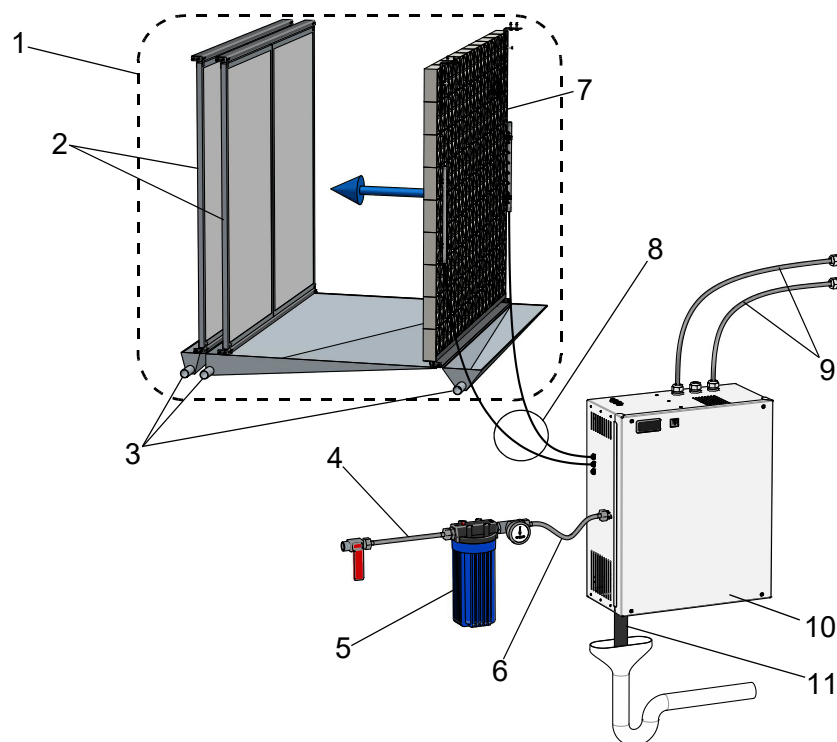

Schematic diagram of the system components

1	installations in humidification chamber with darkenable inspection window (according to VDI 6022) and water tray or duct with service doors and water tray	7	spray system (exemplarily shown with two nozzle segments)
2	aerosol separator (2 step), exemplarily	8	pressure hoses, max. length 15 m*
3	wastewater drain connections, with tap	9	electrical connections
4	water supply via cock	10	pumpstation and control
5	water filter with pressure gauge	11	1 1/4" water drain hose to free running tap
6	water supply connection hose		

* The length of the connecting hoses must be adjusted so that no loops or rings are created. Otherwise, emptying and drying according to VDI6022 cannot be guaranteed.

4.4 Control options (modes of operation)

The usability of the modes of operation described below depends on the actually available physical system implementation, i.e. the number of available nozzle sections. On the other hand, the system must be engineered for the respective number of loads. The number of loads required was specified when the system was ordered.

Basic prerequisite for operating the system is the enabling via the safety (interlock) system (terminals 1/2 on terminalblock X1) by a max. hygostat or other on-site disengaged locking mechanisms.

4.4.1 Supply air humidification (standard operation)

For controlling the system, an on-site control signal of 0...10 V (0...20 mA / 0...140 Ω) is required. All nozzles provided are driven with an atomisation pressure of 5...15 bar proportionally following the resulting actuator signal. The system reaches maximum possible humidification output at 100 percent of the drive signal.

4.4.2 Supply air humidification 2 load mode (normal requirements; comfort humidification)

This mode is only available on a system featuring at least 2 independant nozzle sections.

For controlling the system, an on-site control signal of 0...10 V (0...20 mA / 0...140 Ω) is required that is transformed in an internal actuator signal by the control electronics.

In the range from 0 to approximately 50 percent of the actuator signal, only one nozzle section is driven with an atomisation pressure of 5...15 bar. This range is called „1st load“.

When the actuator signal reaches 50 percent plus **hysteresis** (switching point 1 plus hysteresis), the pumping station switches on the second nozzle section and reduces the pressure to 5 bar. Up to an actuator signal of 100 percent, the output pressure on the nozzles rises proportionally up to 15 bar and the sys-

tem reaches the maximum possible humidification output. Beyond the switching point the system works in the „2nd load“.

Hysteresis of the switching thresholds is essential in order to prevent the control from oscillating. It is relevant for all of the load switching points, i.e. for more than 2 loads as well. Factory setting is 1.0%, i.e. the threshold for switching to the 2nd load mode is 50 % upwards and 49 % downwards.

4.4.3 Supply air humidification 3 load mode (process humidification)

This mode is only available on a system featuring at least 3 independant nozzle sections. For controlling the system, an on-site control signal of 0...10 V (0...20 mA / 0...140 Ω) is required that is transformed to an internal actuator signal.

In the range from 0 to approximately 30 percent of the actuator signal (switchpoint 1), only one nozzle section is driven with an atomisation pressure of 5...15 bar, the so called „1st load“. When the actuator signal exceeds this level, the pumping station switches on the second nozzle section and reduces the pressure to 5 bar. Beyond that up to approximately 60 percent, the nozzle output pressure is proportionally increased until it reaches its maximum of 15 bar. This is the range of the „2nd load“. Beyond that level the third nozzle section is switched on („3rd load“) while the pressure is decreased to 5 bar again. Up to an actuator signal of 100 percent, the output pressure on the nozzles rises proportionally up to 15 bar and the system reaches the maximum possible humidification output.

4.4.4 Exhaust air cooling

The LPS nozzle system was either ordered for exhaust air cooling in a dedicated way or may be switched to exhaust air cooling mode in case of a combined system (s. section 4.4.5). For the control signal, all varieties are available that are allowable for supply air humidification as well. In contrast to supply air humidification operation, load switching is not included in exhaust air cooling mode.

Target of the exhaust air cooling is to add maximum cooling capacity to the supply air stream (with an on-site heat exchanger) in order to boost the air condition systems. Humidification is generally to an extend of 95 to 100 % r.h.. When the system is enabled, all of the nozzles are instantly driven with maximum power. If the hygrostat or an other on-site sensor determines that cooling is no longer required, system enabling is cut and stand-by mode is entered.

4.4.5 Combined system

A combined system allows for switching between supply air humidification and exhaust air cooling. Supply air humidification can be run in the „Standard“ and „2-load“ modes with the full variety of control signals that are supported by a dedicated system. When exhaust air cooling is selected, however, only 1-step operation is possible.

4.4.5.1 Pump station

The vane pump generates a pressure of up to 15 bar. The maintenance-free variable frequency-driven asynchronous motor enables continuous operation up to 50 Hz. Depending on the speed of the pump, water

pressure and, consequently, the amount of atomized water may be varied. Water pressure is in the range from 5 to 15 bar allowing for the optimum mix of throughput and aerosol size.

Pump station characteristics of the various unit models

Pump station	Max. throughput [l/h]	Max. capacity [kg/h] @ 80 % efficiency	Max. speed [rpm]
LPS 45	56	45	1350
LPS 72	90	72	1350
LPS110	130	110	1350

4.5 Main components

4.5.1 The system cabinet and its installations

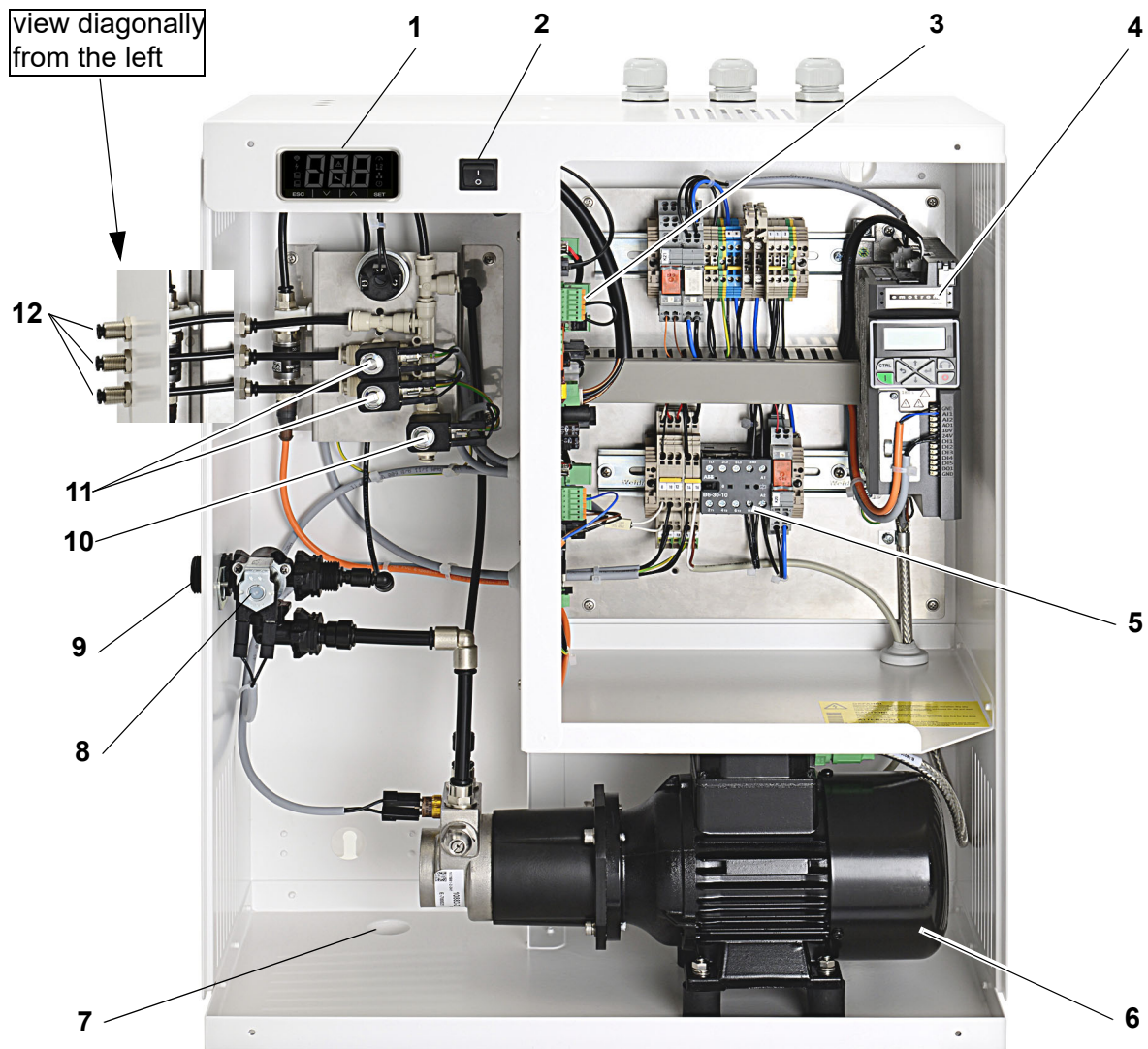

1	Operating panel with display	7	1 1/4" wastewater drain connection, free running
2	Control switch	8	Water inlet solenoid
3	Electronical control unit	9	3/4" supply water connection
4	Frequency converter	10	Solenoid for flushing
5	Main contactor	11	Solenoid for nozzle segments
6	Motor pump	12	Outlets to nozzles, may be mounted on the cabinet top as well (mounting material included in delivery)

4.5.1.1 Electrical, electromechanical and electronical components

The control switch serves for switching the nozzle system on and off. A frequency converter provides the variable frequencies and voltages for the asynchronous motor of the pump station. The pressure water is fed into a manifold with solenoid valves controlling the ports towards the humidification chamber.

The electronic control manages the system control. The operating panel enables the operating of the unit and the programming of parameters. The display is used for monitoring operating data and parameter settings.

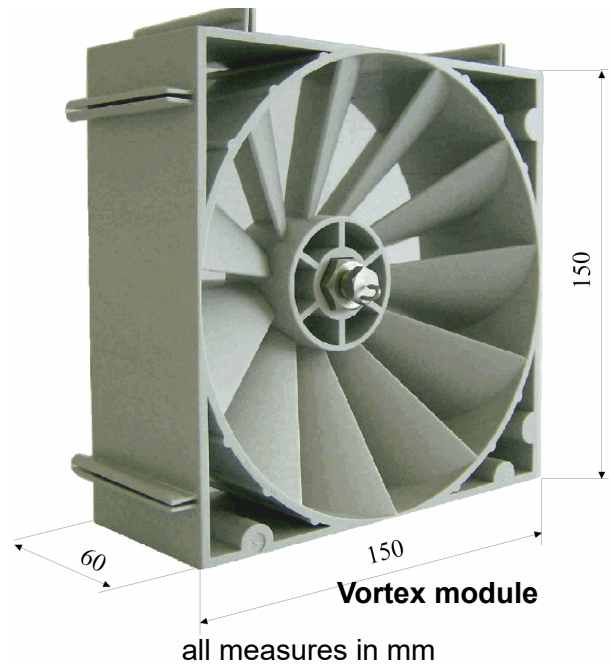

4.5.2 Vortex modules

The vortex modules provide for effective mixing of air and water mist.

Due to their special design, they generate turbulence and shear zones which lead to a homogeneous distribution of aerosols along the humidification section (0.9 m).

The vortex modules (dimensions: 150 x 150 mm) are delivered by piece and may be assembled to form a wall. For optimal moisture absorption air velocity must be in the range of 0.9 to 2.8 m/s. The vortex module wall exhibits a low pressure drop of 80 Pa at an air velocity of 2.0 m/s.



Vortex module wall

4.5.2.1 Atomising nozzles for vortex modules

Desalinated water at a pressure of up to 15 bar reaches the nozzles where the water is atomised to form ultra-fine mist-like aerosols. The aerosols enter the area of the vortexed air stream downstream of the vortex modules. The air and aerosols are mixed intensively here.

Two different types of atomising nozzles are used: atomising nozzles with a spray angle of 120° for general application and those for the edge areas of the vortex module wall featuring a spray angle of 60°.

Functioning:

Water is forced with high velocity into circulation by the swirl insert of the nozzle. Thereby the required atomisation of water into extremely fine aerosols takes place at the outlet opening.

The operating pressure of the water (up to 15 bar) is nearly completely translated into the exit velocity from the nozzle. The higher the operating pressure the finer the droplets.

Spray characteristics operating pressure of 15 bar

- Volumetric flow rate: 4,1 l/h *)
- High percentage of droplet distribution in the range of 9-60 µm

Material of the atomising nozzle: WNr. 1.4404 or AISI 316L

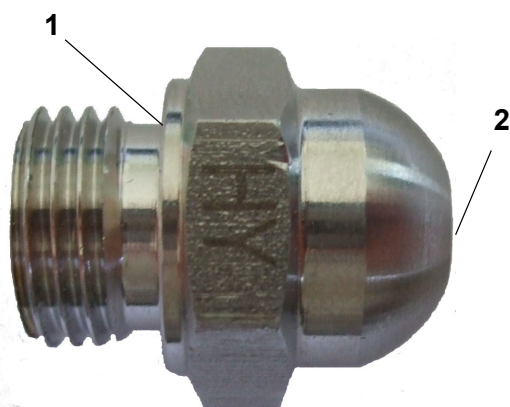

1 - nozzle body 2 - nozzle opening

4.5.3 Aerosol separators

There are no more atomised water droplets in the air stream behind the nozzle system (if the environmental parameter specifications are complied with). For this purpose the aerosol separators are used that may be configured in a 1-step or 2-step arrangement, depending on the application requirements. The dry trap pads exhibit a low pressure drop (30 Pa per stage at an air velocity of 2.0 m/s and an average air density of 1.2 kg/m³).

The air velocity should be between 0.9 m/s and 2.8 m/s. If it is outside this range it can cause moisture breakthrough downstream of the aerosol separators - in such cases please first contact HygroMatik.

The aerosol separators are inserted into the humidification chamber via guide rails and are hence easy to remove for servicing. The mounting of the aerosol separators in the humidification chamber is described in detail in the document „Installation and initial operation instructions for HygroMatik adiabatic humidification systems“.

4.5.4 Humidification section

The section between the spray system and the aerosol separators is called the 'humidification section' in this system. It is unobstructed and hence easy to monitor and clean.

Please note

It is recommended that the humidity sensor is mounted in a distance of at least 5 m with respect to the humidification system.

For a total standard installation length of 1.5 m for the nozzle system the humidification section should have a length of at least 0.9 m.

4.6 Flushing functions

The nozzle system offers a number of flushing variants in order to cope with the hygienic and maintenance oriented requirements. Flushing can be accomplished with supply water pressure only or through use of the vane pump, depending on a parameter setting. Also, the duration of the flushing function may be altered by the setting.

The following flushing variants are supported:

Manual flushing

Manual flushing is started by setting a parameter in the „Adiabate functions“ function group and stopped by resetting the parameter. The water inlet solenoid valve and the flushing valve are both opened.

Dead leg flushing

Dead leg flushing is to prevent microbial contamination due to water resident in the water supply. When dead leg flushing is activated, after a wait time defined by a parameter, a fully automatic flushing of the system is accomplished with line pressure while the inlet solenoid and the flushing solenoid are open. It is not required that the safety (interlock) system is closed for that purpose. The duration of the flushing may be varied by the setting of a parameter.

Hygiene flushing

The need for hygiene flushing comes from VDI 6022. After a settable wait time with no demand present, the whole water system with all of the nozzle segments must be flushed (VDI 6022 requires that the wait time is not longer than 48 hours).

Optimized flushing on demand

Internal algorithms in the control program monitor the operating conditions and trigger the flushing of the nozzle segments for humidification or the nozzle segment for cooling (if present). These flushings follow a sequence that is predefined in the control program.

5. Humidification chamber

5.1 Structural composition of a humidification chamber

The fig. hereafter schematically shows the composition of a vortex module wall and two aerosol separators in a humidification chamber with the hygienic and safety prerequisites required (drains, darkenable inspection window).

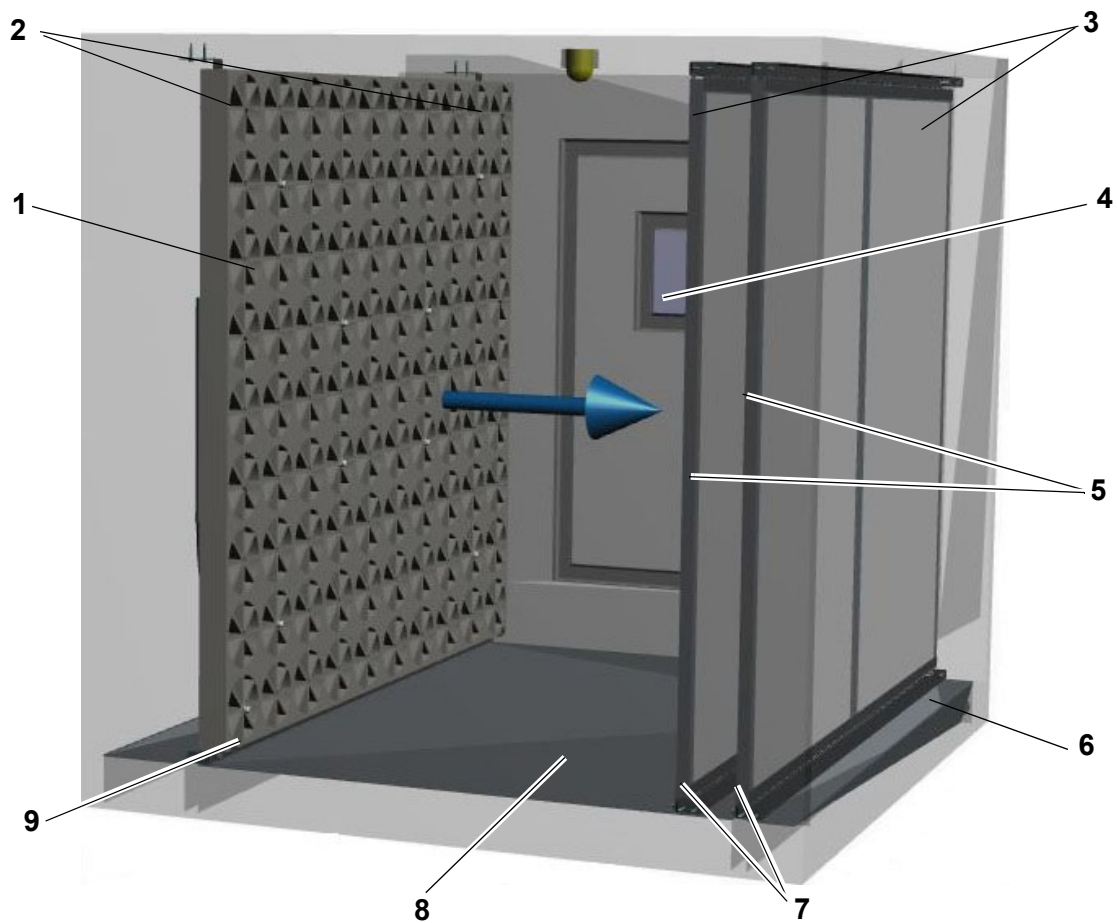

1	vortex module wall with spray system	6	drain with trap, free draining
2	upper mounting angle pieces for spray system	7	lower guide rails for aerosol separators
3	upper guide rails for aerosol separators	8	collection tray
4	inspection window, darkenable	9	lower guide rail for spray system
5	aerosol separators		

5.2 Mechanical assembly Vortex wall

This section is for the company in charge of the duct installations. For the operator of the nozzle system, the following remarks are for information only.

Please note

The installation of the device and the humidifier chamber may only be carried out by personnel with appropriate expertise.

HygroMatik accept no liability for damages resulting from incorrect assembly.

The assembly of the spray system and the integration of the aerosol separators in the humidification chamber are described in detail in the „Installation and initial operation instructions for HygroMatik adiabatic humidification systems“ document. Following below is a line-up of the bullet points for overview purposes:

- The guide rails and mounting angle for the vortex module wall and aerosol separators can be supplied on-site. The guide rails must already be installed before system start-up. Also, the vortex module wall and aerosol separators must already be installed
- The guide rails must be designed in a way that the vortex module wall and aerosol separators can be removed (for servicing)
- The humidification component should be built like a scrubber housing with a decline of at least 1.5° towards the trap (siphon) and should be waterproof
- The water outlet must feature siphon and allow for free draining
- The humidification chamber should be aerosol-tight and it should be able to withstand desalinated water.
- The minimum humidification section length (distance between spray system and aerosol separators) is 0.9 m. This corresponds to a total installation length of 1.5 m (see fig. 2 in the „Instal-

lation and initial operation instructions for HygroMatik adiabatic humidification systems“ document). Should this installation length not be feasible, please contact HygroMatik

- Next to the spray system and the droplet separators (in direction of the humidification chamber walls), a minimum distance of 0.5 m to other installed components must be maintained
- The air flow must be laminar. i.e. in case of a fan installed upstream of the spray system, a minimum distance of 1.0 m must be obeyed or other measures must be taken
- Ensure that after installation the humidification chamber is leakage-free
- Before initial start-up of the system check again that the humidification chamber has been thoroughly cleaned. In particular the humidification chamber and the ventilation duct upstream of the chamber must be free from metal swarfs to prevent corrosion

NOTICE

Risk of material damage to the vortex module due to excessive temperature.

The vortex modules must not be exposed to temperatures >60 °C.

Please note

Mounting or insertion of additional equipment is only permitted with the written consent of the manufacturer. Otherwise the guarantee and warranty will become void.

6. Mechanical installation

▲ WARNING

Risk of foot injuries!

Prevent unit from dropping during installation! Helping hand of a second person is advisable.

▲ WARNING

Risk of electrical shock!

Hazardous electrical voltage. During installation, the unit must be disconnected from power supply and secured against being switched on again. The absence of voltage must be ensured by a measurement.

6.1 Environment Parameters to be met and Mounting Recommendations

When selecting the installation site for the HPS unit, take the following into account:

- Protection class IP20
- By design, HygroMatik steam humidifiers are not qualified for outdoor installation (electrical components and water-bearing parts may be damaged)
- Ambient temperature must lie between +5 and +40 °C (+41 and +104 °F) in order to protect the unit electronics against damage; frost may damage the steam cylinder, the solenoid valve and pump, as well as make hoses burst
- Relative humidity must not exceed 80 % r.h., since values beyond may lead to electronic malfunction or damage
- Installation in a closed room requires aeration and, eventually, temperature conditioning in order to meet the a.m. environmental conditions
- Make use of existing water connections for supply and draining

- The on-site waste water connection must be a free outlet according to DIN EN 1717.
- The installation room must be properly ventilated and equipped with a floor drain. Alternatively, a water stop device (e.g. leakage detector) can be used.
- Use genuine spare parts only
- After any repair work, have qualified personnel check the safe operation of the unit
- Attaching or installing of **additional components** is permitted only with the **written consent** of the manufacturer

NOTICE

The low-pressure nozzle system is IP20 protected. Make sure that the unit is not object to dripping water in the mounting location.

6.2 Unit installation

HygroMatik LPS units are designed for wall mounting. The unit should be mounted on a stable wall. Due to the high weight of the unit, the wall bracket included in the scope of delivery must be used.

If no suitable wall is available, this bracket can be used for floor mounting as an alternative. In this case the bracket is assembled differently and screwed to the floor.

NOTICE

The screws supplied are designed for mounting on a concrete wall/floor. Should you find other local conditions, please use appropriately adapted mounting material.

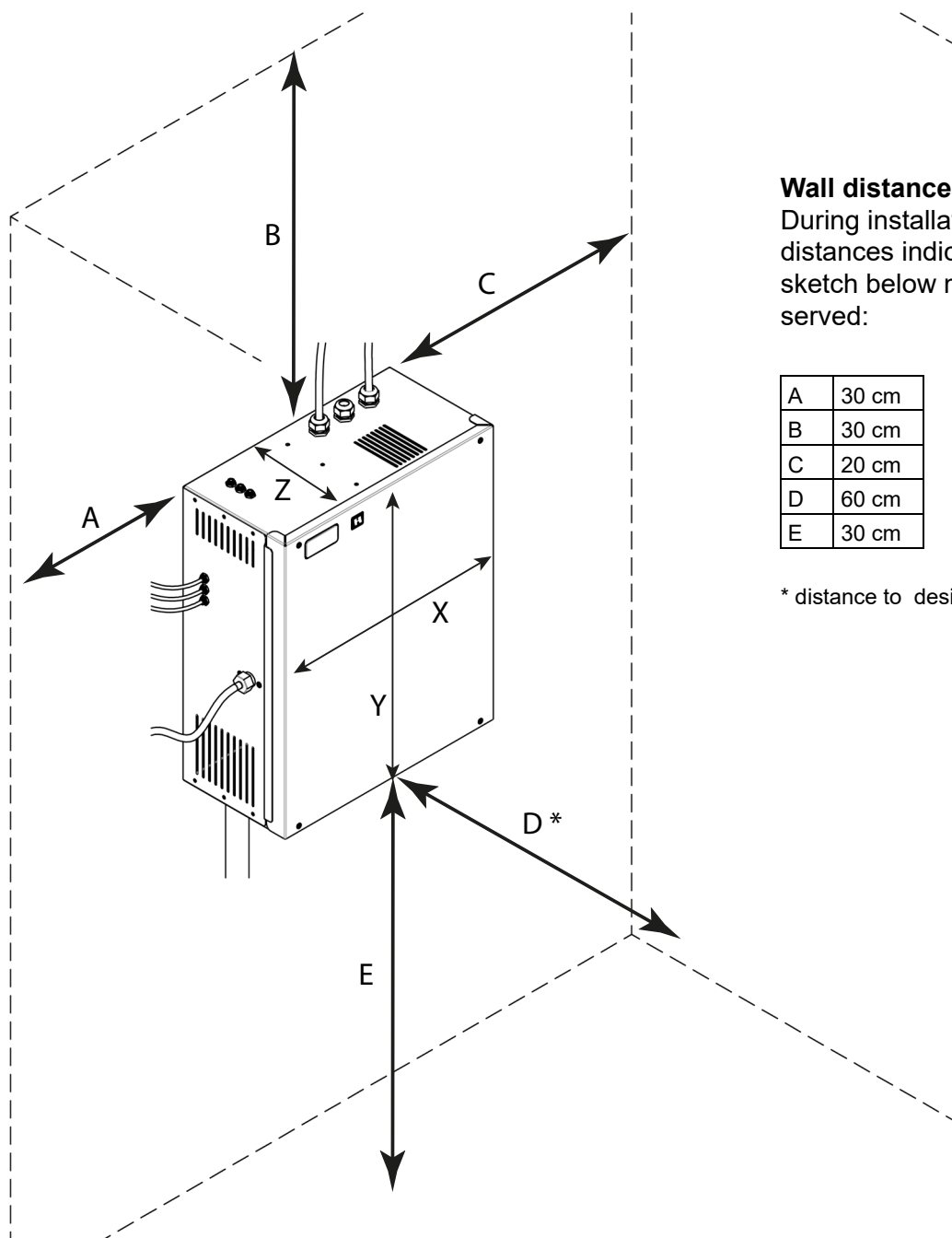
Wall distance

During installation, the wall distances indicated in the sketch below must be observed:

A	30 cm
B	30 cm
C	20 cm
D	60 cm
E	30 cm

* distance to designated paths

NOTICE

When arranging the installation, also take into consideration the need to lay all hoses with a constant downward slope. In addition, the hoses between the pump station and the Vortex wall must be laid along the shortest possible path with the appropriate length. Hoses that are too long must not be laid in loops or rings, as otherwise empty running cannot be guaranteed in accordance with VDI 6022.

6.3 Unit dimensions

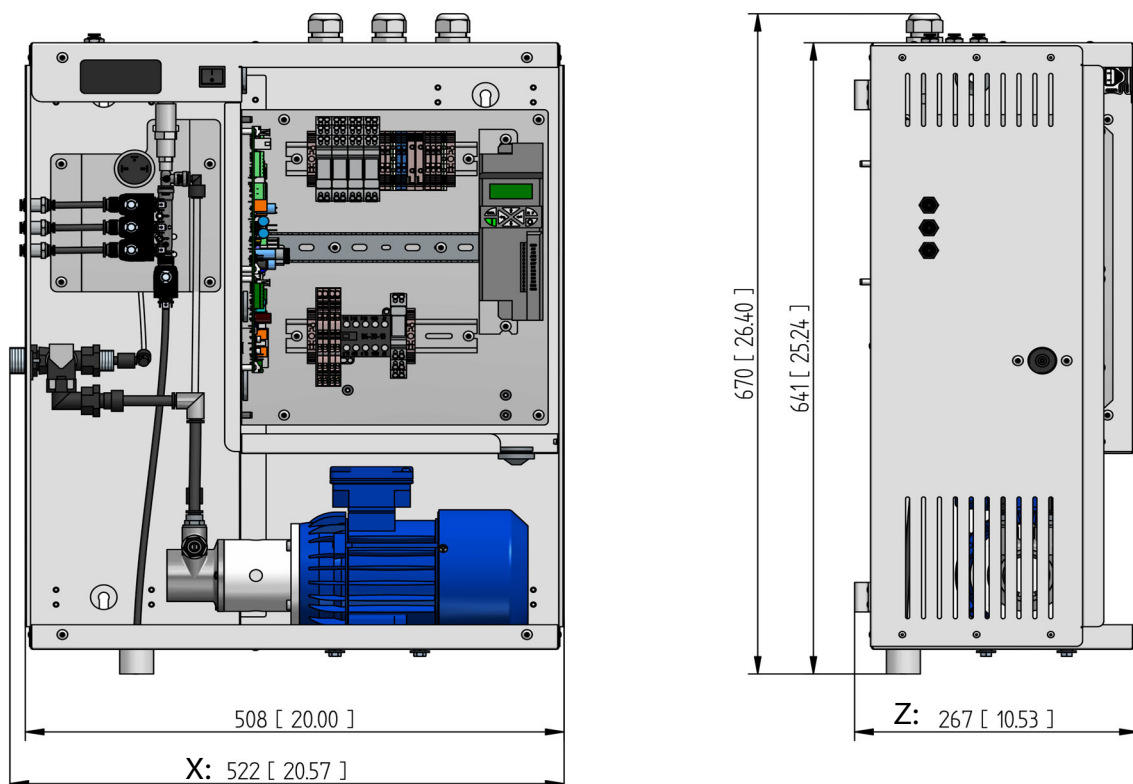

6.4 Unit connections

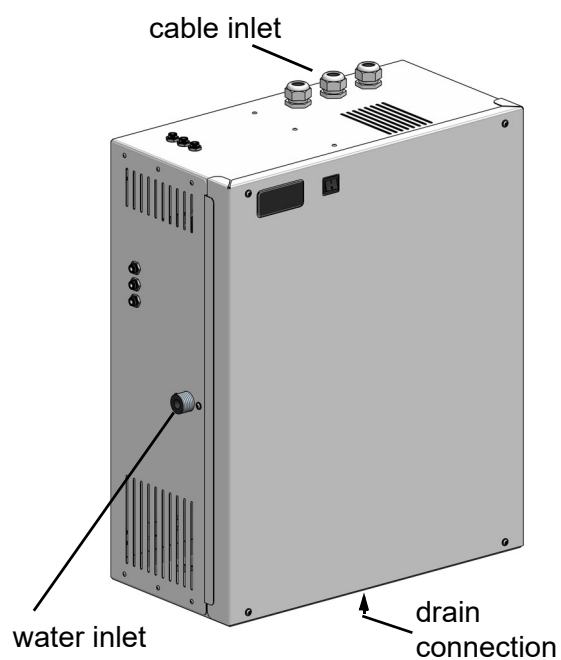

6.5 Hydraulic wiring diagram

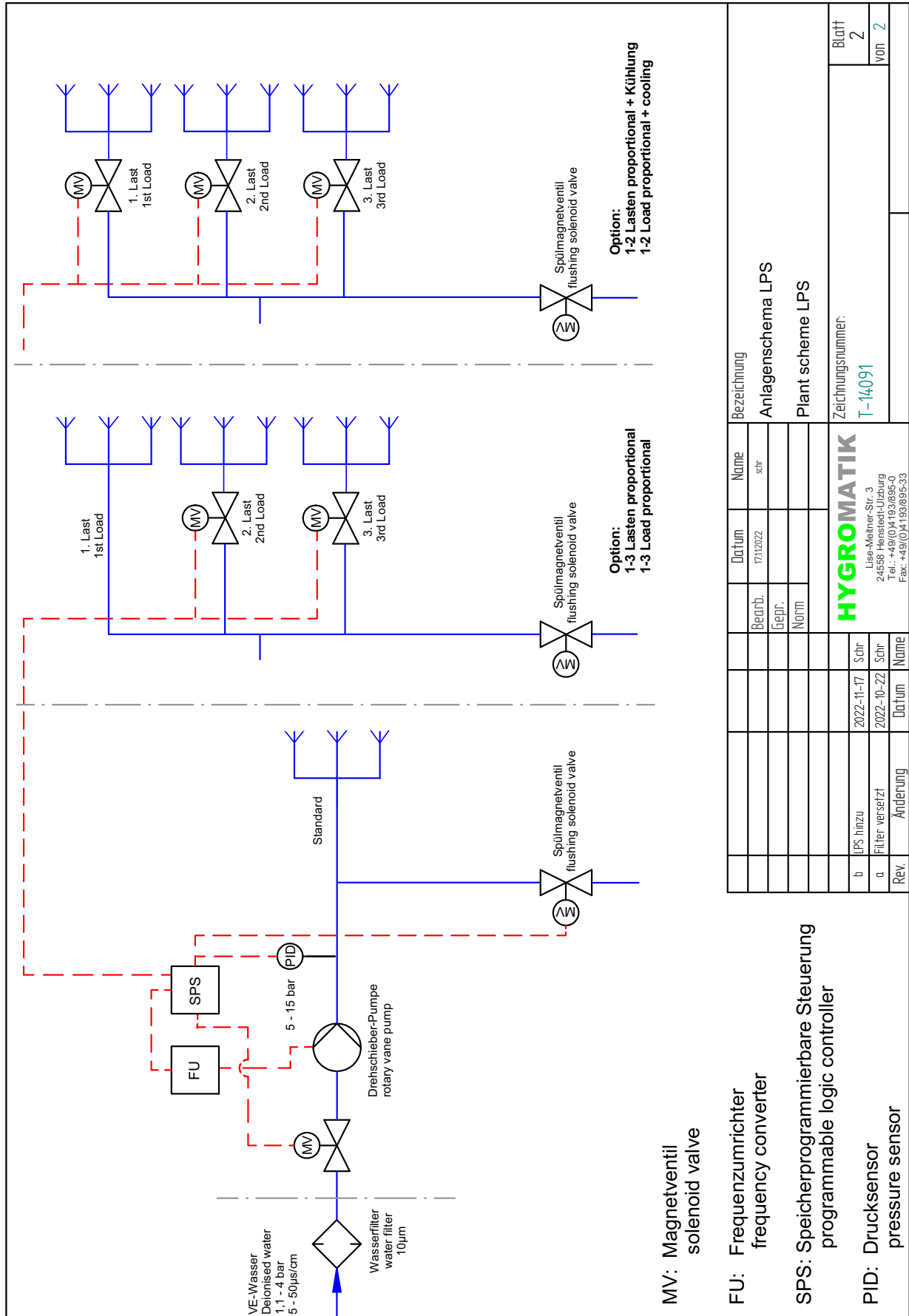

7. Supply and waste water connections

⚠ WARNING

Risk of electrical shock!

Hazardous electrical high voltage!
Before starting installation work ensure that the unit is not yet connected to the power supply.

General rules

- Obey local water utility regulations
- Have all installation work done by expert staff (plumber or personnel with comparable expertise)
- If desalinated water is used we recommend that stainless steel or plastic pipes be used
- All hygienic requirements must be met (s. section 6.2.1 Supply water quality)

7.1 Schematic view

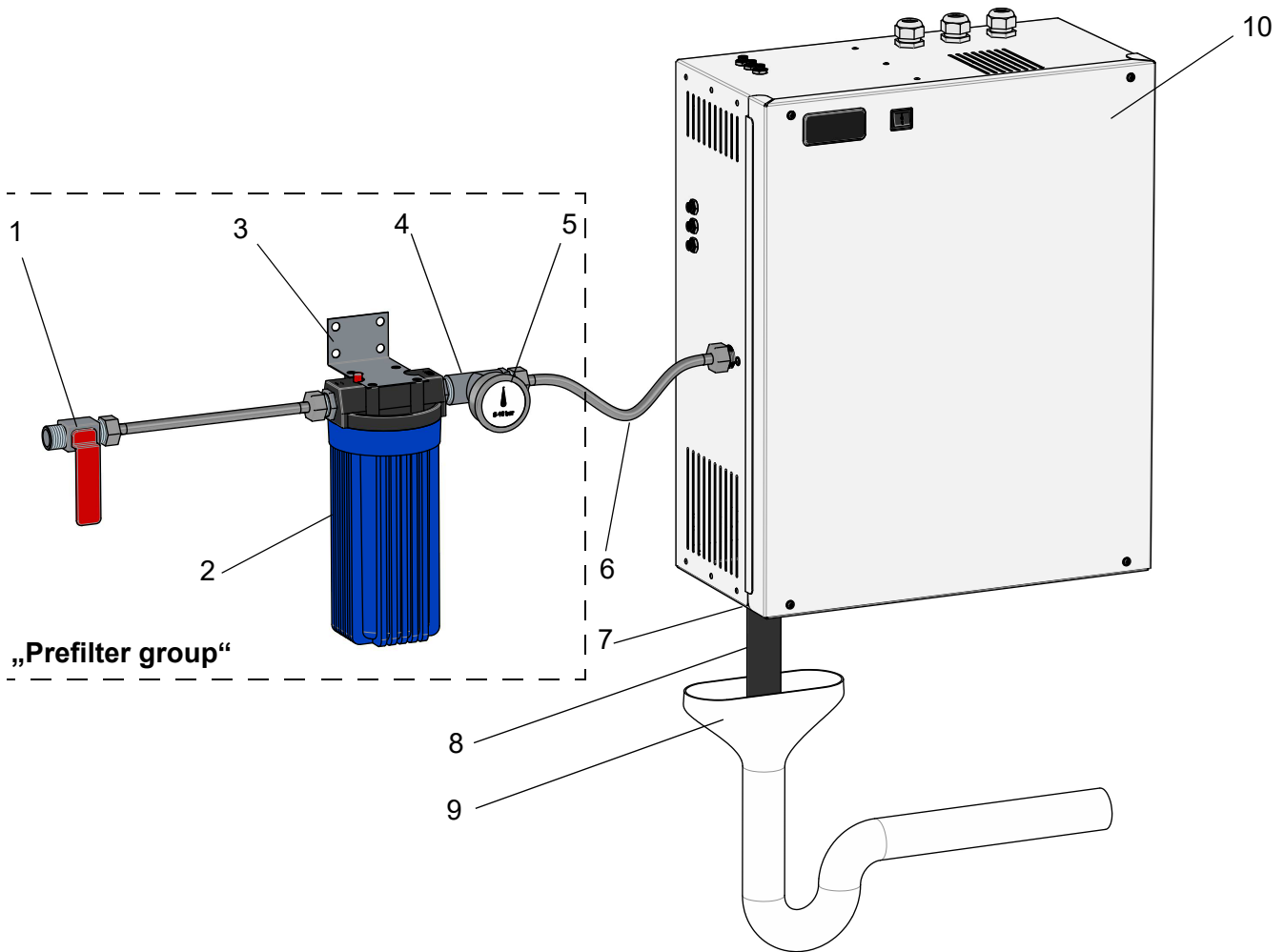

1	water supply with cock	6	3/4 " water connection hose
2	water filter (intake and outtake with 3/4" external thread)	7	1 1/4 " hose connection on cabinet (not shown in fig.)
3	mounting bracket	8	1 1/4 " hose mounted to cabinet hose connection (on-site requirement)
4	T-piece (part of water connection set)	9	external drain with tap (free discharge required)
5	pressure gauge 0...10 bar	10	pump station

7.2 Water inlet

Water inlet implementation

Mount waterfilter (2) close to pump station (10) following these steps:

- » Transfer mounting bracket (3) hole pattern to a suitable location on wall.
- » drill holes, dowel and attach mounting bracket with the mounting material included with the water filter.
- » Screw T-piece included in water connection set to water filter outlet and affix pressure gauge.
- » Connect open T-piece outlet with pump station using the water connection hose supplied.
- » Connect the external feed water line to the input side of the water filter ($\frac{3}{4}$ " external thread).

7.2.1 Supply water quality

Please note

The supply water for the nozzle system must comply with VDI 6022; i.e. from a microbiological point of view it must be of drinking water quality.

A flameresistant sampling tap is to be provided on-site in the direct vicinity of the pump station.

Conductivity: 5...50 $\mu\text{S}/\text{cm}$

Pressure: 0.1..0.4 MPa (1.0...4 bar)

Volume flow: greater than the max. transpiration capacity of the nozzle system

Temperature: 5...15 °C

pH value: 7 +/-1

7.3 Water drain

At the bottom of the housing, a $1\frac{1}{4}$ "spout sticks out as a water drain used for :

- emptying and relieving the pressure lines to the spray system after the enabling signal has been removed
- draining the flushing water from the feed water line in a flushing process
- drain leakage water that may occur from the pump station

Implementation of the water drain

- » $1\frac{1}{4}$ " water hose (8) is attached to the $1\frac{1}{4}$ " spout on the bottom and fastened with a clamp. The $1\frac{1}{4}$ " water drain hose must show a constant decline towards the drain (9), must include a siphon and allow for free draining.

7.3.1 Water drain of the humidification chamber

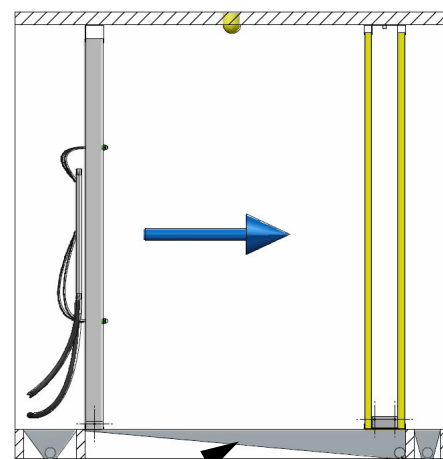

Collection tray

Water drain

The water drain must be located at the lowest point of the collection tray and must feature a siphon. The water downstream of the siphon must drain off freely.

7.4 Water connection final check

Water supply

- Was the water filter supplied as part of the delivery inserted in the water supply to the pump station?
- Is the feed water quality within the prescribed range?
- Is the supply water connection between the waterfilter and pump station leak free on both ends?

Water drain

- Is the drain hose siphoned and installed with a constant decline towards the drain?
- Can the flushing water drain-off freely?

Humidification chamber

- Is the humidification chamber provided with a drain at the lowest point of the collection tray?

8. Hygiene

8.1 Ensuring hygiene (VDI 6022)

The regulations require that only inert materials must be used and biocides should only be used as a last option.

A metal filter made of mesh wire is used as a aerosol separator.

The aerosol separators can - if necessary - be easily cleaned and reused. Addition of a biocide is not required.

8.2 Automatic flushing

According to VDI 6022, flushing of the system is required regularly within a 48 h time frame if no demand calls for the system operation. To meet this requirement, the LPS control initiates automatic flushing every 12 hours in order to prevent microbial contamination in standing water.

During flushing the inlet water solenoid valve and the flushing valve are simultaneously open. Thus, water supplied to the pump station is directly fed into the drain bypassing the spray system.

In this situation, a momentary increase of humidity in the air conditioning system may happen. Thus, in order to warrant the drying of the air condition system after flushing, the regular operation must be ensured.

8.3 Air feed for the nozzle system

Please note

The air flow must be laminar, i.e. in case of a fan installed upstream of the spray system, a minimum distance of 1.0 m must be obeyed or other measures must be taken.

Air purity

A pre-filter according to ISO ePM1 50% (Class F7) is to be placed upstream of the nozzle system.

Air velocity

0.9...2.8 m/s (ideal conditions)

If the air velocity is outside this range please contact HygroMatik.

Pressure drop

Pressure drop is approx. 80 Pa (with an air velocity of 2.0 m/s in a setting of one Vortex module wall and two dry aerosol separators).

9. Electrical connection

⚠ WARNING

Danger of electrical shock!

Dangerous electrical voltage!
All work relating to the electrical installation may only be carried out by designated specialist personnel (electrician or qualified person with equivalent training).

Please note

The customer is responsible for monitoring the qualifications of the specialist personnel.

Do not connect the nozzle system to the live power supply before all installation work has been completed.

General installation rules

- All local rules concerning the implementation of electrical installations must be obeyed
- Electric connector cables to be laid professionally
- Install the electrical connections according to the wiring diagram
- Electrical connection to a permanent line is mandatory (according to VDE 0700 Part 98, IEC 60335-2-98) with circuit breaker ratings as required by the technical specifications of the unit
- Ensure that all terminal screws are securely fastened

NOTICE

Possible electronic components destruction through electrostatical discharge!

Prior to commencing electrical installation work, steps (e.g. ESD protection) must be taken to guard the sensitive electronic components of the unit control against damage from electrostatical discharge.

9.1 Electrical installation approach

⚠ WARNING

Danger of electrical shock due to remanence voltage!

The frequency converter terminals can show hazardous voltages for some time even after switching off.

Before touching the terminals wait at least **180 secs.**

Since leakage currents > 35 mA may occur, a second PE conductor must be connected to the second PE terminal. Use

- 2.5 mm² wiring in the case of protected installation
- 4.0 mm² for unprotected installation

Please note

If a residual current device is to be installed upstream of the system a universal-current-sensitive circuit-breaker should be selected.

9.2 Main connection

Main connection: 1/N/PE_AC_230V, 50 Hz

Pump station	Nominal power [kVA]	Nominal current [A]	Fusing [A]
LPS 45	0.15	1.9	1 x 16
LPS 72	0.16	2.1	1 x 16
LPS 110	0.18	2.7	1 x 16

Please note

When sizing the connection lines, observe that the supply impedance must be low! If a short circuit occurs the circuit-breaker must switch off automatically within 0.4 s. The magnetic short circuit trigger for the circuit-breaker (type B) responds immediately when the flowing short circuit current is more than five times the rated current.

9.3 Safety (interlock) system

Across terminals 1 and 2 on terminal block X1, the so called safety (interlock) system is attached. The safety (interlock) system allows for the wiring in of safety devices. With an open safety interlock, the nozzle system LPS does not commence or ceases operation.

Integration of a max. hygrostat into the safety interlock is state-of-the-art. The max. hygrostat serves as a safety element in case of malfunction of the humidity sensor and protects against over-humidification. Further interlock contacts, such as from air flow relays, duct pressure switches, ventilator interlocks etc., are to be serially wired into the safety (interlock) system across terminals 1 and 2 of X1.

Please note

The contacts across terminals 1 and 2 of X1 must be potential-free and suitable for 230 VAC switching.

⚠ WARNING

After commissioning the HygroMatik nozzle system LPS, a voltage of 230 VAC is present on terminal 1 of ST1.1 on the expansion board (wired to terminal 1 of terminal block X1).

NOTICE

If the ventilation system fails or the supply air face velocity is too low (less than 0.9 m/s) the site monitoring must switch off the nozzle system via the safety interlock. Otherwise undesired condensate build-up behind the aerosol separator may occur.

9.4 Inspecting the electrical installation

The electrical installation must be checked by an electrician in accordance with customer requirements and the regulations set out by the public electricity supply company:

- Does the mains voltage match the voltage specified on the nameplate / delivery note?
- Have all electrical connections been carried out according to the connection diagrams?
- Have all electrical screw and plug cable connectors been attached properly?
- Are the switch-off conditions for protection in case of faults complied with?
- Has the system been earthed?

The system can then be switched on.

10. Commissioning

The description following hereafter is a short instruction for the commissioning of the nozzle system.

In this form, it is primarily ment for recommissioning after decommissioning of the system. For **initial start-up** of the unit by the company in charge for the installation of the nozzle system, a much more detailed document is available with the title „Installation and initial operation instructions for HygroMatik adiabatic humidification systems“.

▲ WARNING

Improper installation hazard!

Start-up of the unit is restricted to HygroMatik staff or authorized personell only.

▲ WARNING

Risk of electrical shock!

Hazardous electrical voltage!
Follow safety instructions for work on live components.

Commissioning steps

Prior to **Initial start-up**, the prerequisites required on-site must be met. Pls., confirm by the notification of readiness form attached at the end of the section (sent by fax or e-mail) that this is the case.

Step 1: Check wiring and hose connections

- » Check that all electrical wire connections are tight and secure.
- » Check hose connections for secure clamping and safe connections.

Step 2: Switch-on the nozzle system

- » Switch on main breaker.
- » Open water supply stop cock.
- » Switch on unit by setting control switch to "I".
- » Close safety (interlock) system.

Step 3: The unit performs a self-test and, then, commences normal operation

- During self-test, the On/Off button icon  flashes for a couple of seconds
- The software version of the controller is displayed briefly
- Consequently, normal operation is commenced. However, without a demand pending no humidification or cooling takes place

Step 4: Trigger demand

- » Set control to 1-step operation, i.e. permanent demand.
- » The vane pump starts operation and transfers water to the nozzles with a pressure of up to 15 bar/217.6 psi.
- » Water is atomized by the nozzles.

Step 5: Monitor unit function and check for leakage

- » Let unit operate for about 30 minutes with the duct ventilator running for humidity transport.
- » If leaks appear, switch off the unit.

Step 6: Repair leaks and correct improper spray image

- » Re-work hosing and distribution tube connections, if required.
- » When nozzles drip, check presence and correct seating of o-rings.
- » When spray image is unsatisfactory, clean nozzles in ultrasonic bath as described in the maintainance section.
- » Repeat actions until everything is o.k..

Step 7: All electrical functions must be executable

- » Run through menus and verify system control functions

End of Commissioning.

Number: 751 F 58 03	Page: 1 / 1	
Responsible department: Engineering	Professionally tested: Mar	
Compiled: 12/05/2016	Released: 12/05/2016 - KI	

Readiness report for initial operation of an LPS system

Company	Service/hotline
Address	Lise-Meitner-Str. 3 24558 Henstedt-Ulzburg
Contact person	Tel. : +49(0)4193/895 -293
Telephone	Fax : -39 E-mail : hotline@hygromatik.de Web : www.hygromatik.de

System: LPS **order number:** AB

System designation / place:

Ladies and Gentlemen,

For initial operation the following sanitary / electrical connections must be connected and functioning:

- Client supplied power supply (230V, 50 Hz)
- Water supply (demineralised water) with line pressure of 1 – 4 bar
- Control signal 0-10 V plus release
- Drains connection DN40
- Mounting rails are installed according to the manual.
- Vortex module wall incl. spray nozzle system fitted and installed in the mounting rails
- Aerosol separators are inserted into the mounting rails and professionally sealed
- Fan, damper register and control ready for a test run of the total system
- LPS hose duct (scope of supply vortex module wall) installed

We require for initial operation of the system approx. 4 hours per unit. For the duration of this period the unit must be capable of being turned off from time to time and the control signals of being manually adjusted. The presence of the client-provided control technician is therefore absolutely necessary.

Please send us this readiness report if possible **10 working days** before the desired date.

Sincerely yours
Your HygroMatik service team

We confirm that the above-mentioned connections are fully ready.

Desired date for placing in service: _____

If for reasons on the client side initial operation cannot be carried out on site e.g. unavailability of water or power supply, travel costs and time expended are subject to charge.

Date: _____

Company/signature: _____

11. Description of control

11.1 General description

The control is integrated into the unit housing and is operated via an operating panel with display on the front of the unit.



The only other operating element, which is also located on the front of the unit, is a control switch whose positions are assigned as follows:

Pos. "0": The unit is switched off

Pos. "I": The unit is switched on and the control is active

By changing the parameters, the operator can adapt the control to the system specifications and the special characteristics relating to the use of the unit.

Operation of the control is described in detail in section 11.

11.2 Layout of control

The control consists of the display, the mainboard and an expansion board that is attached to the mainboard. The mainboard can be expanded for additional functions with additional optional relays in DIN rail format. The DIN rail relays are connected via cables with plug. Up to 2 additional relay modules can be used, with 2 relays each.

The external circuitry for the control voltage and the interlock (safety) system (wired to the X1 terminal block) are fed to the control electronics via plug ST1.1 of the expansion board

and are looped from there to the mainboard. Fusing of the control voltage is made on the mainboard by two 2.5 A fast-blow fuses (F1, F2).

The low voltage supply power für expansion board is channeled from the mainboard to the expansion board through plugs ST11.1 and ST08. This connection is also used for the bidirectional serial data exchange between the logic modules on the two boards.

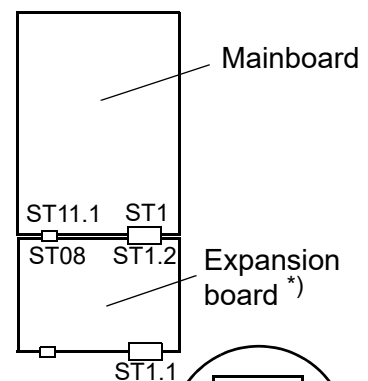

Connections

(via terminal block X1):

L,N: 230 VAC control voltage
1,2: Interlock (safety) system

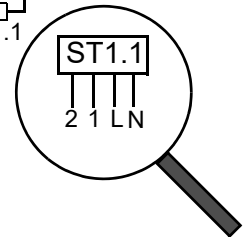

*) The expansion board is referred to as „Cylinder expansion“ in other sections of this manual due to internal reasons.

11.3 Mainboard

The mainboard is "the heart" of the control. The main board of the HPS and LPS units always consists of two boards (main board 1 and extension board).

11.3.1 Mainboard 1

All logic functions and control operations for the nozzle system are provided here. For driving the main contactor, the flushing solenoid valve and the 2nd-load solenoid valve, three relays are located directly on the mainboard. A fourth relay, the „basic relay“, can be programmed for signalling and switching tasks. For additional functions, the optional available relays on the plugs ST10.1 and ST10.2 can be used.

Ex-factory relay assignment:

In case of a unit without any additional options built in, assignment of the base relay (ST03) is „Collective fault“. All other relay contacts carry the assignment „Not in use“.

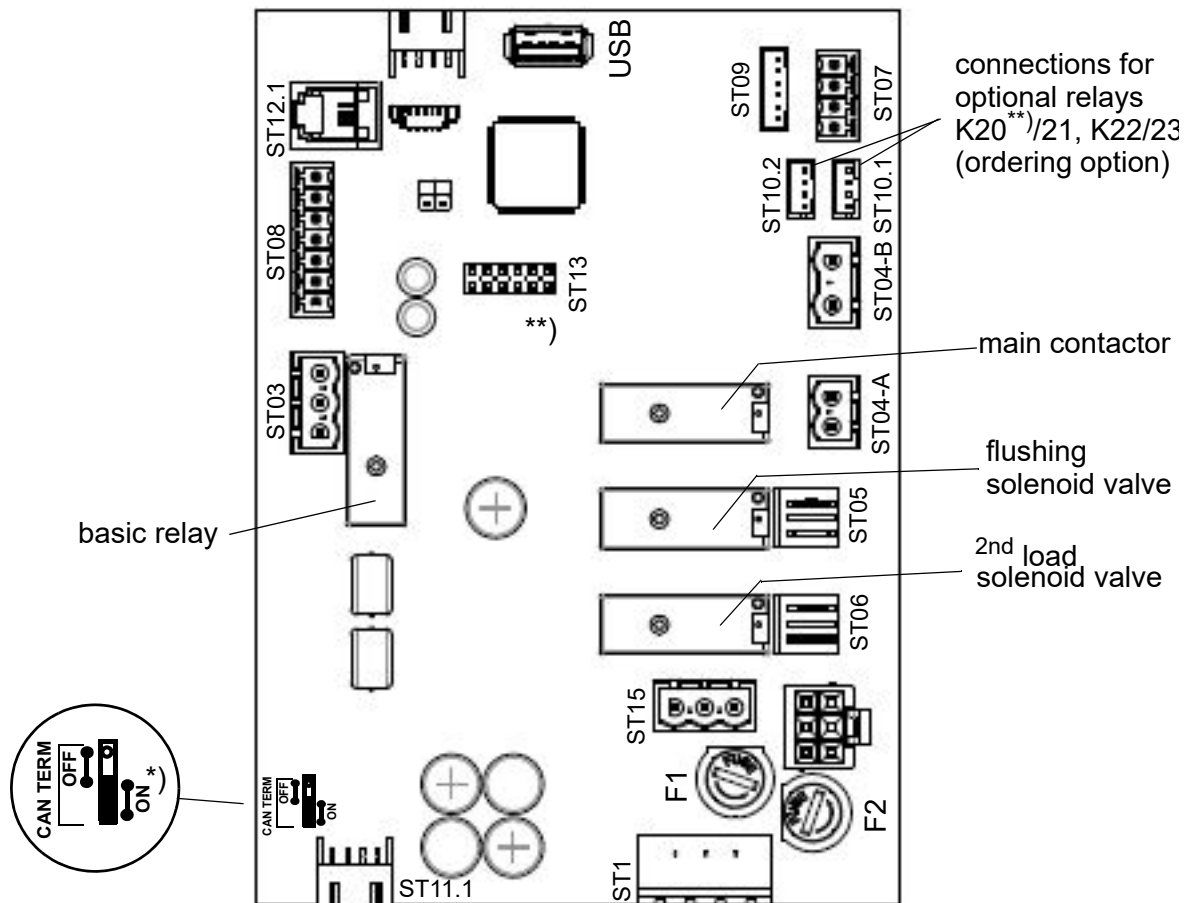

*) This jumper must always be set to „ON“

**) K20 is built-in ex factory for the switching of the 4th load exhaust air cooling in case of 4-load and combined systems

11.3.2 Connections on the main-board

11.3.2.1 Customer-side interfaces

Inputs

ST08:

- 05: control signal input 0...10 VDC
- 06: control signal input 0...20 mA
- 07: control signal input 0...140 Ω
- 08: digital input „Start cooling“ (12 VDC)

Outputs

ST03:

- Potentialfree NC and NO contacts of the basic relay. Ex-factory assignment of the basic relay is „collective fault“. The assignment can be changed to an other signalling or switching function by programming the relevant parameter

ST10.1/ST10.2:

- Connections for a pair of optionally orderable relays K20/K21 (ST10.1) and K22/K23 (ST10.2) each in DIN rail version with wiring harness, usually freely assignable. When a combined system was ordered, K20 and K21 are part of the delivery. K20 is then used in exhaust air cooling mode for the control of the „cooling“ valve. K21 is freely assignable.

ST07:

- Control output for driving the frequency converter (0...10 VDC)

ST08:

- 03: +20 VDC supply (max. 20 mA)

USB:

Connection for USB stick for use as a data logger and for parameter or software updates

11.3.2.2 System-side interfaces

ST1:

- L1,N and the interlock (safety) system connection, looped via ST1.2 of the expansion board

ST11.1:

- +12 V, GND, CAN-Bus

Inputs

ST09:

- (0-I): Plug monitoring (12 VDC)
- (14): Temperature 50 °C (5 VDC)
- (16): Pump temperature (5 VDC)

ST04-B:

- Pressure switch in water inlet (230 VAC)

Outputs

ST04-A:

- Main contactor (230 VAC)

ST05:

- Flush valve (230 VAC)

ST06:

- 2nd load (230 VAC)

Bi-directional

ST12.1:

- Serial interface for display and operating panel connection
-

ST 13:

- Base for adapter board with RS485 interface

11.4 Expansion board

The expansion board provides - besides further inputs - additional relays for the switching of the water intake solenoid valve and the 3rd load (the 1st load is selected by default when humidification starts, the 2nd load is switched on the main board). In case of a combined system, only 2 loads can be switched. The relay contacts on ST04 are then used for switching the supply air humidification - in the 1st load.

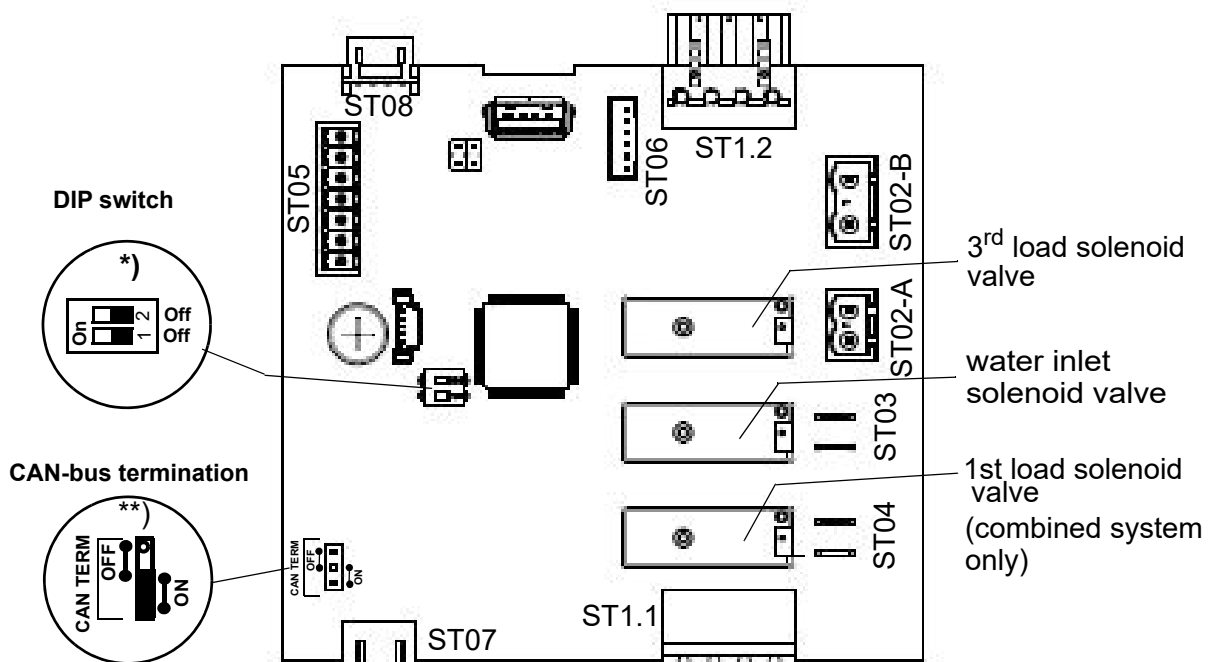

*) The DIP switches serve for CAN-bus address setting. They are factory preset according to the unit configuration. When replacing an expansion board, ensure the identical setting is made as it was before.

**) For the terminating resistor to be effective, the jumper for CAN bus termination on the expansion board must also be set to "ON".

11.4.1 Exchange / connection of the extension board

If it is necessary to replace / connect the extension board, set the DIP switches beforehand:

DIP switch 1-OFF and 2-ON

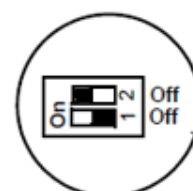

11.4.2 Connections of the expansion board

Inputs

ST05:

- 06: High pressure sensor (0...20 mA)
- 08: Digital input for switching between humidification/cooling (12 VDC)

ST1.1:

- 4-pin screw / plug connection for the connection of L1 and N and the interlock (safety) system

ST1.2:

- Loop-through of ST1.1 for on-passing to ST1 of the mainboard

ST07:

- +12 V, GND, CAN-Bus

ST08:

- Loop-through of ST07

Inputs

ST02-B

- Pump motor temperatur (230 VAC)

ST06:

- 0-I: Plug monitoring (12 VDC)
- 14: Fault frequency converter (5 VDC)

Outputs

ST02-A:

- 9/N: 3rd load (230 VAC)

ST03:

- 10/N Water intake solenoid valve (230 VAC)

ST04:

- 11/N: 1st load (230 VAC), only with combined system

11.5 Connection terminals block

Depending on the particular implementation, the connections in question may also be made via the central terminal block X1.

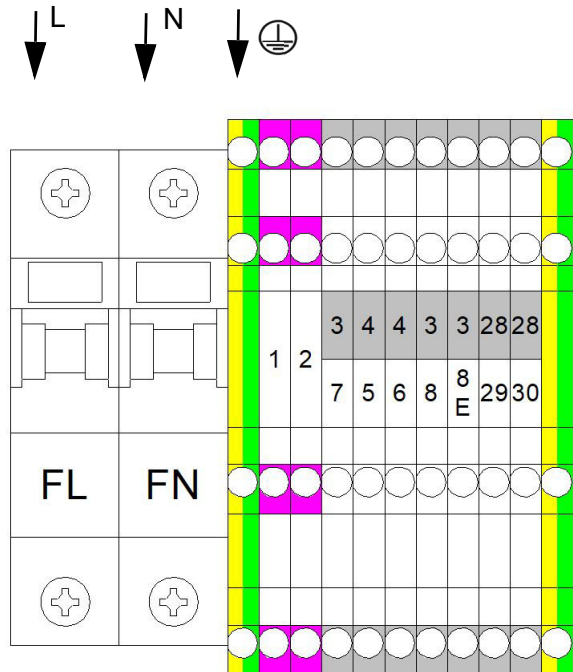

- Power supply 230V/50Hz at X1:FL und X2:FN
- Potential-free contact for release at X1:1 and X1:2
- Up to 4 freely programmable relays K20-23
- 1-step X1:3/5
- 0-10V X1:4/5
- 0-20mA X1:4/6
- 0-140 Ohm X1:4/7
- If active sensors are used, X1:3 serves as power supply 20VDC (max. 30mA)
- Switching between humidifying and cooling X1:3/8E
- Start cooling X1:3/8
- Basic relay (free configurable) X1:28/29/30

11.6 Electrical connection

▲WARNING

Danger of electric shock!

Dangerous electric voltage!

All work relating to the electrical installation may only be carried out by designated specialist personnel (electrician or qualified person with equivalent training).

Please note

The customer is responsible for monitoring the qualifications of the specialist personnel.

NOTICE

Potential component damage due to electrostatic discharge!

To protect the sensitive electronic components, measures to prevent damage due to electrostatic discharge must be taken before the start of the installation work.

11.6.1 Connection of control voltage

The control voltage of 230 VAC is to be applied to terminal block X1 and, from there, is fed to the expansion board (plug ST1.1). Depending on the unit configuration, the terminal block X1 terminals for control voltage connection are labeled „FL“ and „FN“ in case of additional fusing implemented.

11.6.2 Connection of interlock (safety) system

The so-called interlock (safety) system is located between terminals 1 and 2 of the X1 terminal block. Safety equipment can be wired (also in series) into the interlock (safety) system. If the interlock (safety) system is open, the high-pressure nozzle system does not start or the operation is interrupted.

In air conditioning, it is standard to incorporate a max. hygostat in the interlock (safety) system. The max. hygostat is used as a safety feature in case of a malfunction of the humidity sensor.

▲WARNING

Danger of electric shock!

Dangerous electric voltage!

After the initial operation of the unit, a 230 VAC voltage is present at terminal 1 of ST1.1 (expansion board).

Safety (interlock) system

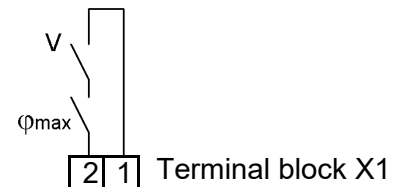

Terminals 1/2 wiring on terminal block X1 for connection of the safety (interlock) system

Please note

The interlock (safety) system is not closed when delivered ex-factory!

Please note

The contacts, which are connected to terminals 1 and 2 must be potential free and suitable for switching of 230 VAC.

11.6.3 Terminal wiring for the various modes of operation

Standard operating mode of the HygroMatik nozzle system LPS is „supply air humidification“. Optionally, a „combined unit“ that supports both modes of operation in a switchable form may be ordered (the various modes of operation were described in section 4.4). Each of the operational modes requires a particular terminal wiring that is shown in the figs. below. Any switching contacts (to be supplied by the customer) need only be low-voltage proof. Depending on the particular implementation, the connections in question may also be made via the central terminal block X1.

11.6.3.1 Terminal wiring for supply air humidification (standard delivery)

1-step operation

Terminal strip on ST08

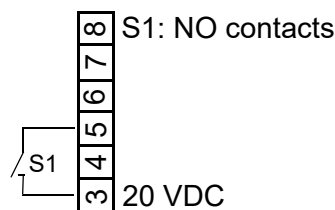

Terminal 3/5 wiring on the mainboard (terminal strip on ST08) for 1-step operation

Operation with active humidity sensor or external controller

When driving the high-pressure nozzle system with an active humidity sensor or through an external controller (e.g. a PLC), physical control signals in the range of 0...10 V, 0...20 mA or 0...140 Ω can be used. For each of the signal variants a particular terminal is provided on the mainboard. In all cases, reference potential is terminal 4, „GND“.

Wiring variants (exemplary):

Terminal strip on ST08

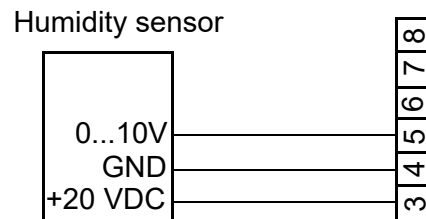

Terminal 3/4/5 wiring on the mainboard (terminal strip on ST08) for connection of a humidity sensor 0...10 V

If an external control signal 0...10 V is used, wiring is to be made to terminal 4 (GND) and 5 (signal) . Wiring for a resistive signal 0...140 Ω is across terminals 4 and 7. A humidity sensor with current output 0...20 mA is to be wired across terminals 4 (GND) and 6.

Please note

Active humidity sensors require an external supply voltage. Terminal 3 provides +20 VDC for that purpose.

Terminal strip on ST08

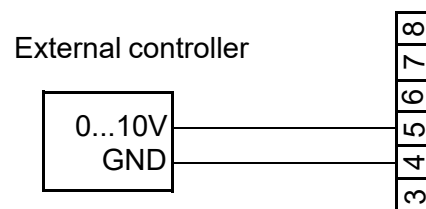

Terminal 4/5 wiring on the mainboard (terminal strip on ST08) for connection of a 0...10 V external control signal

Terminalstrip on ST08

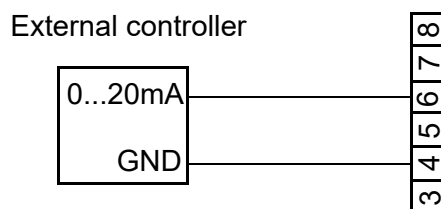

Terminal 4/6 wiring on mainboard (terminal strip on ST08) for connection of an external control signal 0...20mA

11.6.3.2 Terminal wiring for a combined unit (ordering option)

A combined unit allows for the alternative operation of supply air humidification and exhaust air cooling. The supply air humidification mode supports all available control variants while the exhaust air cooling is always run in 1-step mode. Switch-over between the two alternative operational modes is accomplished by switch S3 on the terminal strip on ST05 of the expansion board. For the exhaust air cooling to become effective, switch S2 must additionally be closed. Switch S1 is not functional in exhaust air cooling mode. It is used for activating 1-step operation (S1 closed) in supply air humidification mode.

Supply air humidification/exhaust air cooling switch-over

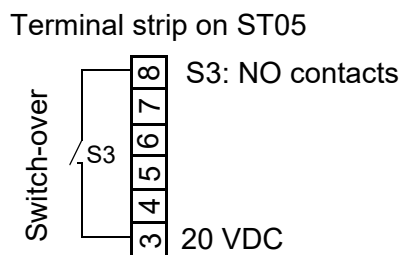

Terminal 3/8 wiring on the expansion board for switching-over between supply air humidification (S3 open) and exhaust air cooling (S3 closed), making use of digital input

The parameter „Digital_input_function“ (17:cylinder extension/1) must be set to „50“.

Switch-on of exhaust air cooling

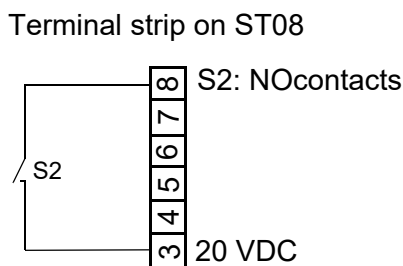

Terminal 3/8 wiring on the mainboard (terminal strip on ST08) for switch-on of exhaust air cooling (S2 closed). In order for S2 to become effective, S3 on ST05 must be closed.

Switch for 1-step operation in supply air humidification mode

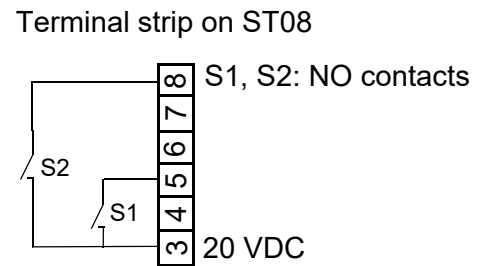

Terminal 3/5/8 wiring on the mainboard (terminal strip on ST08) for 1-step operation (S1 closed) and activation of the exhaust air cooling (S2 closed).

Operation with active humidity sensor or external controller

Terminal wiring of the mainboard is to be made as for the standard unit (supply air humidification ex-factory), exemplarily shown below for the connection of an active humidity sensor. Additionally, the terminals 3/8 on ST05 of the expansion board must be wired with S3 for switch-over between humidification and cooling.

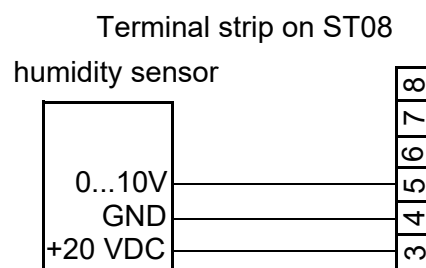

Terminal 3/4/5 wiring on the mainboard (terminal strip on ST08) for connection of a 0...10 V active humidity sensor

12. Control operation

12.1 Principal user guidance

On powering up the nozzle system, the software version is shown in the display for a few seconds. In normal operation, the display then shows actual humidification output as a standard display. When a key is pressed, the first reading in a list of reading and input values is indexed. The complete list may be visualized by scrolling using the arrow keys.

By means of inputting a 2 digit code, access to „Advanced level“ is possible (for input code see table in section „Advanced level submenus and relating parameters“). The advanced level parameters are functionally grouped in submenus (1) to (7). The code input is reset to its standard („0“), should no keystroke occur within 3 minutes.

12.2 Menu structure

Overview on menu structure

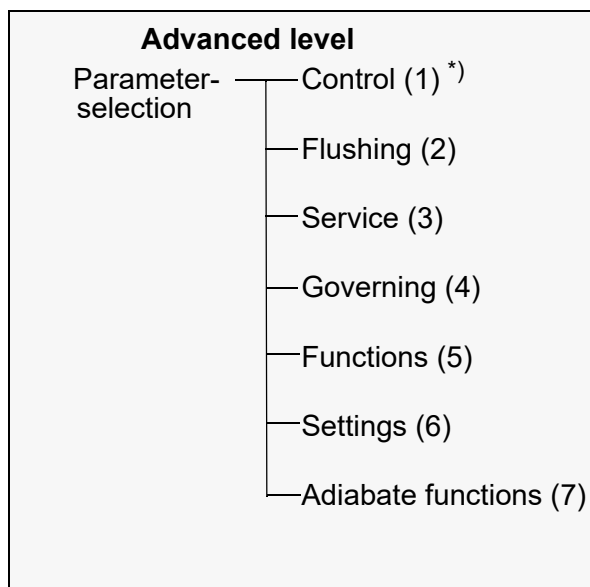
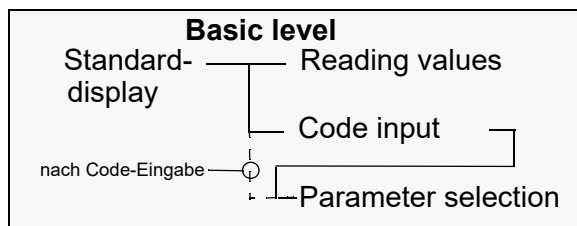

*) numbers in paranthesis are group numbers

Basic level

From standard display (actual steam output) basic level may be accessed by pressing any key on the control panel. On basic level, among other information reading values r01 to r45 are available. After a certain time span with no keystroke control switches the display back to standard display. Factory setting for this time out is „5 minutes“.

Besides showing the reading values, basic level also features „P00“ for code input allowing advanced level access (s. „Menu tree section“).

Advanced level

On advanced level, the control parameters of functional groups (1) to (7) (s. „Overview on menu structure“) may be individually changed.

Menu tree

The detailed menu tree with all of the reading values and settable values as well as all of the parameters is depicted in the next section.

Parameter descriptions

A tabular list of the advanced level parameters and a more detailed description may be found in the sections „Advanced level submenus and their parameters“ and „Detailed parameter descriptions“, respectively, further down in this chapter.

12.3 Menu tree

Basic level

Advanced level ²⁾

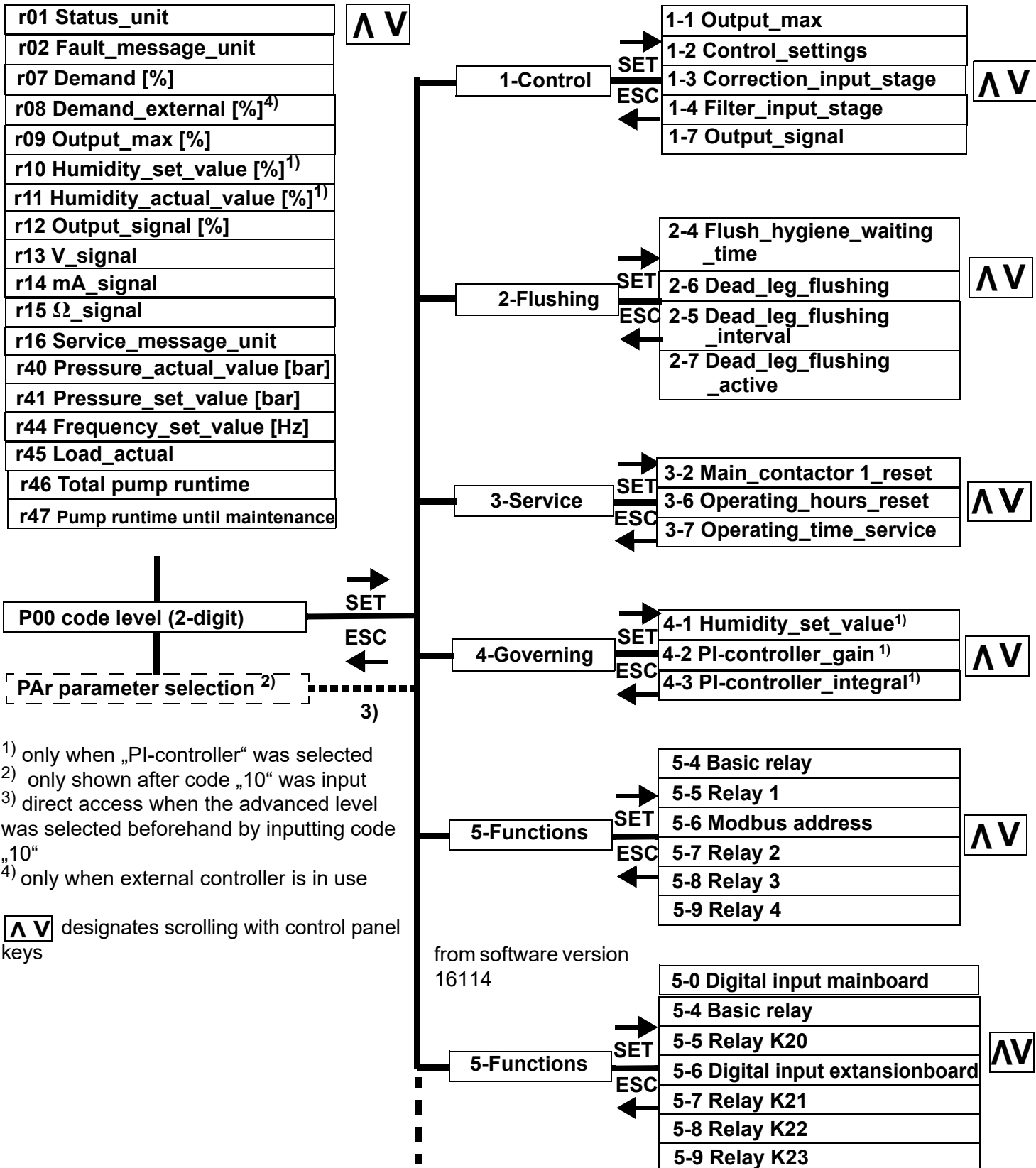

Advanced level 2)

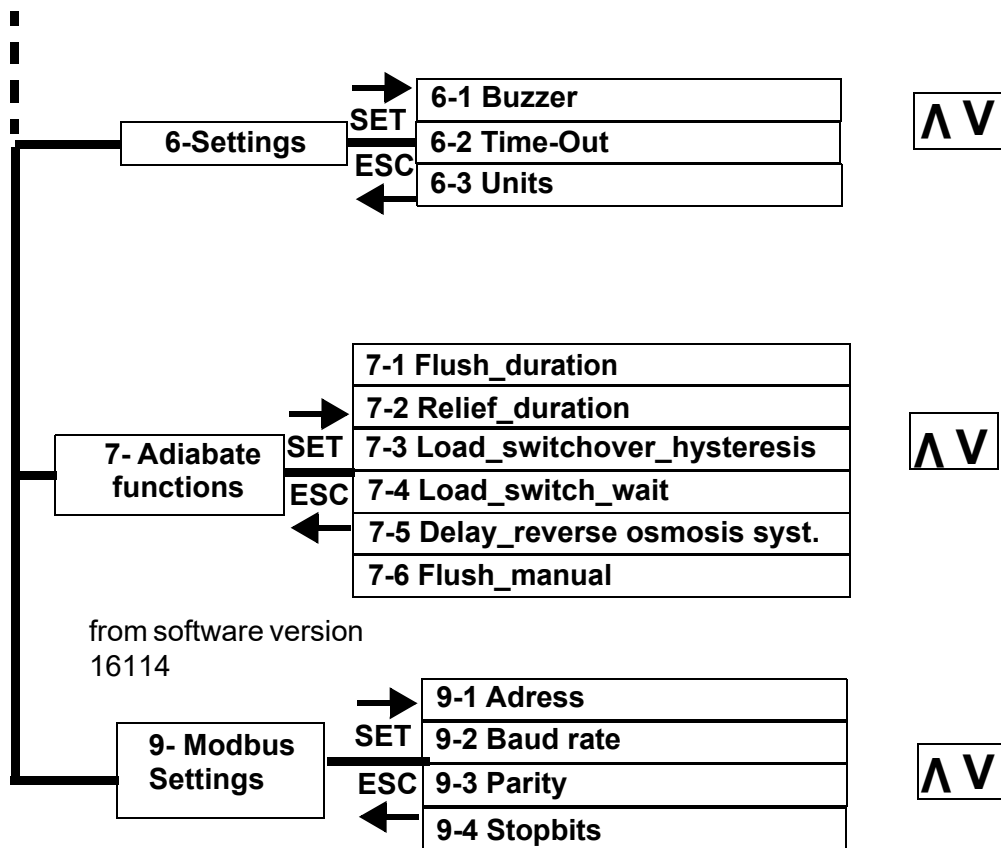

12.4 The control panel



The control panel comprises 3 sections:

- the ESC, SET, **^**, **v** control keys
- the 3-digit 7-segment display
- dedicated icons for operating status indication

Please note

A flashing icon always indicates a faulty situation!

Exception: When switching the unit on, the complete display flashes 4 times. Then, the power-on-LED blinks while the device self test is run.

The **control keys** enable navigation in the menus and submenus. Their function is as follows:

„ESC“: cancellation or return to previous level

„**^**/**v**“ : move up/down within a menu, submenu or selection list.

„SET“: accept and store a selected setting.

The 3-digit **7-segment-display** serves for outputting of operational and input data as well as error code presentation. When control software expects an input the digits are blinked. Display semantics are determined by lightening-up of one or more icons related to a specific operational situation or device control environment.

Icons state table

	permanently lit	flashes
	Humidification/cooling ^{*)} active	<u>In conjunction with error icon:</u> Fault humidification
	Main contactor active	Fault main contactor
	Filling active	Fault water inlet
	Draining active	Fault draining
	(State not possible)	Error s. error codes
	Maintenance required	(State not possible)
	Demand	Fault control signal
	Safety (interlock) system closed	(State not possible)
	Virtual safety (interlock) system closed by software enabling	(State not possible)
	Control active	Control self test after cold start

^{*)} Cooling only with systems for exhaust air cooling or with combined systems, when exhaust cooling mode was selected

12.5 Navigation within a menu

Basic level entry

Standard display during normal operation is actual pressure in the selected dimension ([bar] or [psi], respectively). By pressing any key, basic level comprising a reading value index (pointer) selection level and the reading values as such is entered.

„r01“ is displayed indexing the first reading value.

Reading value display

By scrolling using the „▲/▼“ keys, the reading value indexes „r01“ to „r45“, code entry „P00“ (s. below) and parameter selection „PAR“*) may be addressed. The actual reading value content is output on pressing the SET key after selection of one of the reading value pointers r01 to r45.

Use the ESC key for return to the reading value index level that allows for addressing further reading values.

„P00“ allows for inputting a code for advanced level entry that supports changing of the parameters (s. next section).

*) „PAR“ ist only presented when a „10“ was input as the „P00“ setting value for access to advanced level. When „PAR“ is confirmed with the SET key, parameter group selection is supported without the need for inputting the access code again.

Advanced level code entry and setting a parameter

- » Using the „▲/▼“ keys, scroll until „P00“ is displayed and confirm with the SET key. A flashing „0“ is displayed.
- » Increase the display to „10“ using the „▲/▼“ keys and confirm with the SET key („10“ is the access code for the provider level). „1-“ is now displayed for selection of one of the parameter groups (1) to (7).
- » Confirm parameter group (1) with the SET key or make an other selection with the „▲/▼“ keys and then confirm. The display will now show a „1“ in the right digit position for addressing the parameter index (e.g., „2-1“).
- » Confirm selection with the SET key or vary selection with the „▲/▼“ keys and then confirm.

Use the ESC key for return to the previous input level.

12.6 Tabular representation of reading value list and provider level submenus

For a detailed description, pls. refer to the respective sections within this chapter.

12.6.1 The reading value list

From normal operation, the user may access the reading value index „r01“ (Status) by pressing any key.

By scrolling using the „▲/▼“ keys, the reading and setting values indicated in the table below may be addressed. To output the value content, the SET key must be pressed first.

Reading value index	Description
r01	Status_unit
r02	Fault_message_unit
r07	Demand [%]
r08	Demand_external [%]
r09	Output_max [%]
r10	Humidity_set_value [%] (only when PI controller was selected)
r11	Humidity_actual_value [%] (only when PI controller was selected)
r12	Output_signal [%]
r13	V_signal
r14	mA_signal
r15	Ω_signal
r16	Service_message_unit
r40	Pressure_actual_value [bar]
r41	Pressure_set_value [bar]
r44	Frequency_set_value [Hz]
r45	Load_actual
r46	Total pump runtime
r47	Pump runtime until maintenance
P00	Code level („0“, „10“)
PAR	Parameter group selection

12.6.2 Advanced level submenus and relating parameters

Detailed parameter descriptions may be found in the section „Detailed parameter description“ further down in this chapter. The „Setting options“ column indicates the presettings available or the range of values to be chosen from. „Fs“ stands for „Factory setting“.

Submenu „Control“ (Group 1)

Par.	Denomination	Setting options	Code
1-1	Output_max. [%]	25 ... 100 FS*) = 100	10
1-2	Control_settings	0= user specified 1= ext. controller, 0 ... 10 V 2= ext. controller, 0 ... 20 mA 3= ext. controller, 0...140 Ω 4= PI-controller, 0 ... 10 V 5= PI-controller, 0 ... 20 mA 6= PI-controller, 0 .. 140 Ω 7= 1-step 8= Modbus FS = 1	10
1-3	Correction_input_stage [%]	-5.0 ... +5.0 FS = 0	10
1-4	Filter_input_stage	0=light, 1=strong FS = 0	10
1-7	Output_signal	0= no designation 1= external demand 2= internal demand 3= R.h. actual value	10

*) FS = Factory setting

Submenu Flushing (Group 2)

Par.	Denomination	Setting options	Code
2-4	Flush_hygiene_waiting_time [h]	0.1...48.0 WV = 24	10
2-5	Dead_leg_flushing	0=deactivated 1=activated WV = 0	10
2-6	Dead_leg_flushing_interval [h]	0.1...96.0 WV = 24	10
2-7	Deadleg_flushing_active [sec]	1...600 WV = 90	10

Submenu „Service“ (Group 3)

Par.	Denomination	Setting options	Code
3-2	Main_contactor 1_reset	0=no 1=yes WV = 0	10
3-6	Operating_hours_reset	0=no 1=yes WV = 0	10
3-7	Operating_time_service [h x 100]	0...50 WV = 25	10

Submenu „Governing“ (Group 4)

Par.	Denomination	Setting options	Code
4-1	Humidity_set_value [%] (PI-controller only)	5...99.9 FS = 50.0	10
4-2	PI-controller_gain [%] (PI-controller only)	0.1...99.9 FS= 5.0	10
4-3	PI-controller_integral (PI-controller only)	0...100.0 FS = 10	10

Submenu „Functions“ (Group 5)

Par.	Denomination	Setting options	Code
5-4	Basic relay	0 = Collect fault 1 = Safety (interlock) system open 2 = No demand 3 = Humidification 5 = Remote off 6 = Safety (interlock) s. low voltage 7 = Safety (interlock) system closed 8 = Humidification fall-delayed 12 = Standby_signal 13 = Initialization 20 = Digital input_active 38 = Pressure_water_input_min 71 = Flush_hygiene 150 = Load 1 151 = Load 2 152 = Load 3 154 = Cooling 270 = Service general 274 = Service main contactor K1 283 = Service operating hours 284 = Relay not used WV = 0	10
5-5	Relay 1	same as for basic relay FS= 999	10
5-6	Modbus address	1...255 FS= 1	10
5-7	Relay 2	same as for basic relay FS= 999	10
5-8	Relay 3	same as for basic relay WV = 999	10
5-9	Relay 4	same as for basic relay WV = 999	10

Submenu „Functions“ (Group 5) from software-version 16114

Par.	Denomination	Setting options	Code
5-0*	Digital input expansion board	see 5-6 FS= 0	10
5-4	Basic relay	0 = Collect fault 1 = Safety (interlock) system open 2 = No demand 3 = Humidification 5 = Remote off 6 = Safety (interlock) s. low voltage 7 = Safety (interlock) system closed 8 = Humidification fall-delayed 12 = Standby_signal 13 = Initialization 20 = Digital input_active 38 = Pressure_water_input_min 71 = Flush_hygiene 150 = Load 1 151 = Load 2 152 = Load 3 154 = Cooling 270 = Service general 274 = Service main contactor K1 283 = Service operating hours 284 = Relay not used WV = 0	10
5-5	Relay 1	same as for basic relay FS= 999	10
5-6	Digital input main board	0 = OFF 40 = Power limitation 50 = Humidify / cool 51 = Cooling on 62 = Service_shutdown 63 = Service_hygrostat 64 = Service_airflow 70 = Steam_enable 81 = Dead leg flushing 82 = Hygiene_flush 90 = Relay FS= 0	10
5-7	Relay 2	same as for basic relay FS= 999	10
5-8	Relay 3	same as for basic relay WV = 999	10
5-9	Relay 4	same as for basic relay WV = 999	10

* Functions 5-0 and 5-6 can only be selected if no cooling has been selected or installed.

Submenu „Settings“ (Group 6)

Par.	Denomination	Setting options	Code
6-1	Buzzer	0=off 1=on FS = 0	10
6-2	Time-out [min]	0 ... 60 FS = 2	10
6-3	Units	0 = SI units 1 = imperial units FS= 0	10

Submenu „Adiabate functions“ (Group 7)

Par.	Denomination	Setting options	Code
7-1	Flush_duration [sec]	1...600 FS= 20	10
7-2	Relief_duration [sec]	1...240 FS = 5	10
7-3	Load_switchover_hysteresis [%]	0.5 ... 1.0 FS = 1.0	10
7-4	Load_switch_wait [sec]	1...10 FS = 3	10
7-5	Delay_reverse osmosis system [sec]	10...180 FS = 10	10
7-6	Flush_manual	0 = no 1 = yes FS = 0	10

Submenu „Modbus settings“ (Group 9) from software-version 16114

Par.	Denomination	Setting options	Code
9-1	Adress	1...255 FS = 1	10
9-2	Baud rate	3 = 9600 4 = 19200 6 = 38400 FS = 4	10
9-3	Parity	0 = None 1 = Odd 2= Even FS = 0	10
9-4	Stopbits	0 = one Stopbit 1 = two Stopbits FS = 0	10

12.7 Exemplary variation of a parameter setting

Example: Control signal is to be changed from „Ext. controller, 0 ...10 V“ („1-2“ = „1“) to „PI controller, 0 ...10 V“ („1-2“ = „4“).

Please note

The steps below make an essential change to a control parameter. If this is not intended, be sure to reestablish the original setting after changing it for exercising purposes.

- » In normal operation, press any key to access the reading value list. „r01“ is displayed.
- » Scroll from „r01“ to „P00“ (Code input).
- » Press SET key. Display now shows a flashing „Zero“ for code level „0“ (user level) and input readiness.
- » Using the „▲/▼“ keys, change the display to „10“.
- » Press the SET key. Advanced level is now entered. „1-“ is displayed as the first parameter group to be changed.
- » Since the parameter is in this group, group confirmation can be made immediately with the SET key.
- » Scroll with the „▲/▼“ keys to the „1-2“ position and confirm with the SET key. The parameter setting „1“ (external controller, 0...10 V) is displayed and may be changed.
- » Change the setting to „4“ (PI controller, 0...10 V) with the „▲/▼“ keys
- » Confirm and save with the SET key.
- » Pressing the ESC key twice brings the display back to standard display (i.e. actual pressure).

These steps are exemplary. In the same way, selection and variation of all of the parameters may be accomplished.

12.8 Detailed description of the basic level reading values and settings

Reading value pointer		Explanation	
r01 Status_unit	Code	Denomination	Description
Main functions category	00	Initialization	The system is in the run-up phase. The „Power-On“-LED flashes.
	01	Safety_interlock_open	The system is ready for humidification/cooling, the safety (interlock) system, however, is open (the safety (interlock) system icon in the display is not lit). If the safety (interlock) system was opened under software control, the status code „05“ (Remote off) is displayed instead.
	02	No_demand	Demand from external controller or active humidity sensor is below switch-on threshold of the system. No humidification/cooling is performed (while the safety interlock is closed). The demand icon in the display is not lit.
	03	Humidification	The system is in „Supply air humidification“ mode, after a demand was triggered by a hygrostat, an external controller or the internal PI-controller (the safety (interlock) system must be closed).
	05	Remote_off	Safety interlock was opened via Modbus (e.g. by a building control system instruction).
	06	No_bus-signal	When 1-2 = „Modbus“ is selected, demand messages are required on a regular base. In case of no demand within a 20 s time frame, „No Modbus“ is shown as the device status and the humidification/cooling is stopped (for details, see dedicated Modbus documentation available from HygroMatik GmbH).
	15	Cooling	The system is in „Exhaust cooling mode“, after a demand was triggered by a hygrostat, an external controller or the internal PI-controller (the safety (interlock) system must be closed).
	18	output_limit_Steam_Off	Device has switched off due to power limitation via external control signal

Reading value pointer		Explanation	
Flushing category	150	Flush_humidification	Automatic flushing of the humidification nozzle segment
	151	Flush_cooling	Automatic flushing of the cooling nozzle segment (if present)
	152	Flush_hygiene	The system performs a hygiene flushing, because no demand for humidification or cooling was present for „x“ hours (wait time „x“ is preset in parameter 2-4)
	153	Dead_leg_flushing	The system performs a flushing of the supply water line in order to prevent microbial contamination
	154	Discharge	The pressure in the spray system is relieved.
	155	Flush_manually	Manual flushing is underway after Par. „7-6“ was set to „1“
	156	Flush_humidification_cooling	Both the humidification and cooling nozzle segments are flushed at the same time.
Servicecategory	270	Service general	A service message is present.
	900	Diagnosis	Unit is performing diagnostics
	901	No program	The control was not yet programmed to support the particular unit model.
	902	Update underway	A USB stick is inserted and the control runs through a parameter update.
	903	Restart required	A parameter update was successfully terminated and a system restart is required.
Fault category	999	Fault	A fault was detected. Operation has ceased. An error code may be read out. Some certain faults also make one or several icon(s) in the display blink.

Reading value pointer	Explanation
r02 Fault_message_unit (only shown when a fault has occurred)	The error code related to the fault is displayed (humidification/cooling is stopped whenever a fault occurs). Error codes are described in the „Trouble shooting“ chapter of this manual.
r07 Demand	The internal signal for controlling the humidification/cooling is displayed [%].
r08 Demand_external (only with ext. controller)	External controller control signal is displayed [%].
r09 Output_max	Power limitation as a percentage of max. output as preset in parameter „1-1“ is displayed [%].

Reading value pointer		Explanation	
r10 Humidity_set_value (only when PI controller was preset)		R.h. nominal value as preset in parameter 4-1 is displayed [%]	
r11 Humidity_actual_value (only when PI controller was preset)		Actual value of r.h. is displayed [%].	
r12 Output_signal		<p>Percentage of the max. output signal (external control signal, internal demand or r.h. actual value) on plug ST0712.</p> <p><u>Explanatory example:</u></p> <ul style="list-style-type: none"> the external control signal is chosen for plug ST0712 by setting par. „1-7“ to „1“ as the external control signal, „0...10 V“ is selected by setting par „1-2“ („Control settings“) to „1“ <p>When the external control signal then amounts to 5 Volt, the reading value „50“ (%) is displayed.</p>	
r13 V_signal		Input signal measured at terminal ST805 [V]	
r14 mA_signal		Input signal measured at terminal ST806 [mA]	
r15 Ω_signal		Input signal measured at terminal ST807 [Ω]	
r16 Service message_unit	Code	Denominat.	Explanation
	0	No_service_msg	A service is not required.
	2	Cycles_main_contactor 1	The maximum number of operating cycles for K1 has been reached and a Service_main_contactor is required.
	7	Operating_time	A service is required due to the number of operating hours.
	15	Water_inlet_pressure_min.	The water inlet pressure is below the specified minimum value. The vane pump operation is on hold until the pressure has maintained the minimum value for a defined period. The occurrence of the service message is recorded in an internal counter. If the service message has occurred 5 times, the fault message Pressure_water input is raised. The internal counter is counted down by 1 each time when the water input pressure has not fallen below the minimum value for a continuous period of 10 minutes.
	16	Nozzles	The nozzle condition of the spraying system requires maintenance.
	18	Control	The control of the humidifier should be optimized.

Reading value pointer		Explanation	
r16 Service message_unit	Code	Denominat.	Explanation
	19	Leakage or loss of pump power	The actual pressure falls below the set pressure by >1bar for at least 180s at a frequency of 50Hz. Cause: slight leaks in the nozzle and hose area as well as pump wear. This service message does not trigger an error. The system continues to run until the minimum pressure is no longer reached. Then the system stops with error message 152. Check and eliminate existing leaks or replace the pump.
	20	Water_inlet_pressure_max.	The water inlet pressure is beyond the specified maximum value. The vane pump operation is on hold until the pressure has fallen under the maximum value.
r40		Pressure_actual_value	The actual pressure value (in bar)
r41		Pressure_set_value	The pressure set value (in bar)
r44		Frequency_set_value	The frequency set value (in Hz) for driving the pump motor
r45		Load_actual	The actual number of loads (nozzle segments that are driven)
r46		Total pump runtime	NN.N thousand hours (Bsp. 12.5 = 12.500h)
r47		Pump run-time until maintenance	in NN.N thousand hours (ex. 2.5 = 2,500h) Remaining run times of <100 h cannot be displayed (the value is then 0). The service message (spanner symbol) only appears when the remaining run time until service has ended. If the service interval is reset, the maintenance interval of 2,500 h starts again.
P00 Code level		Allows advanced level access by code input (Code „10“) or limitation to basic level (Code „00“). Advanced level is exited automatically after 10 mins without a keystroke.	
PAr Parameter selection		Allows selection of parameter group and of a specific parameter within a group on the advanced level (after code input).	

12.9 Detailed parameter descriptions

Group	Par.	Denomination	Explanation
Control	1-1	Output_max.	Power limitation allows scaling down the max. humidification/cooling within a range of 25 to 100 %. The actual humidification/cooling output is determined by the control signal. Power limitation may be necessary for a better control performance.
	1-2	Control_settings	This parameter tells the unit control software what kind of control signal is wired. Also, the control characteristic is defined. These are the setting options: 1 = external controller, 0...10 V 2 = external controller, 0...20 mA 3 = external controller, 0...140 Ω 4 = PI controller, 0...10 V 5 = PI controller, 4...20 mA 6 = PI controller, 0...140 Ω 7 = 1-step 8 = Modbus
	1-3	Correction_input_stages	This parameter allows for an active humidity sensor calibration in the range from -5% r.h. to +5% r.h. .
	1-4	Filter_input_stage	This parameter allows for switching the damping of the input low pass filter from „light“ to „strong“. With a capacitive humidity sensor, increasing the input damping is meaningful for improving the signal-to-noise ratio and for reducing the oscillating tendency.
	1-5	Cut-off point	Setting of the switch-off point as a percentage of the external demand (not when PI-controller was selected)
	1-6	Δ Switch-on point	defines the deviation of the switch-on point with respect to the switch-off-point in terms of a percentage of the external demand (not when PI-controller was selected)
	1-7	Output_signal	Assignment of the output signal on terminal ST0712 to an internal variable 0 = off : no assignment 1 = external control signal : output signal proportionally follows the control signal of an external controller 2 = internal control signal: output signal proportionally follows the internal control signal 3 = r.h. actual value: output signal proportionally follows the r.h. actual value

Group	Par.	Denomination	Explanation
Flushing	2-4	Flush_hygiene_waiting_time [h]	Wait time until a fully automatic hygiene flushing is performed. VDI 6022 requires that wait time is not longer than 48 hours.
	2-5	Dead_leg_flushing	Activation/deactivation of dead leg flushing
	2-6	Dead_leg_flushing_wait_time [h]	After the wait time preset, a fully automatic dead leg flushing is performed. The safety (interlock) system must not be closed for this purpose.
	2-7	Dead_leg_flushing_active [sec]	The duration of the dead leg flushing process is preset with this parameter.
Service	3-2	Main_contactor_1_reset	Main contactor switching cycles are monitored and compared to the life expectancy figure supplied by the part's manufacturer. On a match, reading value r01 is set to „274“ (and the service icon LED flashes). After changing the main contactor, parameter 3-2 must be set to „1“ for a reset of the status message.
	3-5	Factory_reset	All of the parameters are reset to the state at the time of delivery
	3-6	Operating_hours_reset	The operating hours counter is set to „zero“.
	3-7	Operating_time_service [h x 100]	Presetting of the time period (given in hundreds of hours) between two system maintenance events
Governing These parameters are only effective when parameter 1-2 (control signal) holds a setting incorporating the PI controller.	4-1	Humidity_set_value [%] (PI-controller only)	Parameter 4-1 determines the r.h. set value for control.
	4-2	PI-controller_gain [%] (PI-controller only)	Sets the PI controller gain (Xp)
	4-3	PI-controller_integral (PI-controller only)	Sets the PI controller resetting time (Xn).

Group	Par.	Denomina- tion	Explanation
Functions	5-4	Basic relay allocations	<p>The basic relay offers potential-free NC and NO contacts across terminals (28, 29) and (29, 30), respectively, on the ST03 connector (contact capacity is 250 VAC/8A).</p> <p>The relay is activated for signalling (Si) or switching (Sw) purposes when a certain operating status is achieved. Parameter 5-4 allows for allocating a logical function, i.e. the relay is energised when that particular operating status occurs. Factory setting is „0“ defined as „collective fault“</p> <p>The following relay allocations are supported:</p> <p><u>(0) Collective fault:</u> Relay is energised in case of any fault (Si)</p> <p><u>(1) Safety (interlock) system open:</u> Relay is energised in case of the safety (interlock) system being not closed (Si)</p> <p><u>(2) No demand:</u> Relay is energised in case of no demand for humidification or cooling (Si)</p> <p><u>(3) Humidification:</u> Relay is energised in case of humidification or cooling being underway (Si)</p> <p><u>(5) Remote off:</u> Relay is energised in case of the safety (interlock) being opened under software control by means of the building control system (Si)</p> <p><u>(6) Safety (interlock) system via low voltage:</u> relay is energised in case of an additional relay for the closing/opening of the safety (interlock) system in order to avoid hazardous voltage confrontation (Si)</p> <p><u>(7) Safety (interlock) system closed:</u> Relay is energised in case of standard wiring (Si)</p> <p><u>(8) Humidification delayed:</u> Relay supplies signalling after humidification has stopped that may be used e.g. for controlling a drying fan (Si)</p> <p><u>(12) System ready:</u> Relay is energised in case of the system being switched on and not in a fault condition (Si)</p> <p><u>(68) Dead leg flushing:</u> Relay is energised as long as a deadleg flushing is underway (Si)</p> <p><u>(150) Load 1:</u> Relay is energised when the first load is switched (Si)</p> <p><u>(151) Load 2:</u> Relay is energised when the second load is switched (Si)</p> <p><u>(153) Load 3:</u> Relay is energised when the third load is switched (Si)</p> <p><u>(154) Cooling:</u> Relay is energised when exhaust cooling is activated (SI). The switching of the exhaust cooling function is in any case via relay K20 that has a default assignment of „154“ ex-factory.</p>

Group	Par.	Denomina- tion	Explanation	
Functions (ctd.)	5-4	Basic relay allocations (ctd.)	<p><u>(211) Humidity accomplished:</u> Relay is energised in case of the set value r.h. determined by parameter 4-1 is met (Si)</p> <p><u>(270) Service general:</u> Relay is energised in case of any service message beeing present (Si)</p> <p><u>(275) Service main contactor K1:</u> Relay is ener-gised when maintenance is required after the max. number of main contactor K1 switch plays has been reached (Si).</p> <p><u>(284) Service operating hours:</u> Relay is energised when maintenance is required after the max. num-ber of operating hours has been reached (Si).</p>	
	5-5	Relay 1 allo- cation (ST10.1)	<p>Defines logical function of relay K20 contacts (in the same way as 5-4 does for the basic relay). Factory preset is „999“ (relay not used).</p> <p>When the unit was built as a combined system, the relay allocation is „154“ ex factory and cannot be changed. In that case, the relay is used for the direct switching of the cooling nozzle segment solenoid.</p>	
	5-6	Modbus Address	The control electronics may optionally be equipped with a RS485 serial interface for running data communication with the Modbus RTU protocol. 5-6 then holds the Modbus RTU address.	
	from software version 16114	5-6	Digital input mainboard	Allocation of the digital input function [98] of the dig-ital input [97] on the main board 1.
	5-7	Relay 2 allo- cation (ST10.1)	<p>Defines logical function of relay K21 contacts (in the same way as 5-4 does for the basic relay). Factory preset is „999“ (relay not used).</p> <p>In a combined system, when the allocation is „154“, relay K21 may be used for signalling the exhaust cooling activation, while the solenoid for the cooling itself is switched via relay K20.</p>	
	5-8	Relay 3 allo- cation (ST10.2)	Defines logical function of relay K22 contacts (in the same way as 5-4 does for the basic relay). Factory preset is „999“ (relay not used).	
	5-9	Relay 4 allo- cation (ST10.2)	Defines logical function of relay K23 contacts (in the same way as 5-4 does for the basic relay). Factory preset is „999“ (relay not used).	
	from software version 16114	5-0	Digital input extension board	Allocation of the digital input function [98] of the dig-ital input [97] on the extension board.

Group	Par.	Denomina- tion	Explanation
Settings	6-1	Buzzer	The control panel features a buzzer for prompting key strokes. Parameter 6-1 allows for muting the prompt.
	6-2	Time-Out [min]	Unit control switches the display back to actual humidification/cooling output presentation after the time set in 6-2. Factory setting is „2 minutes“
	6-3	Units	This parameter enables a switch between SI units and imperial units. Actual pressure reading e.g. will then be in „psi“ instead of „bar“.
Adiabate func- tions	7-1	Flush _duration [sec]	Flushing duration. Relevant for all types of flushing available.
	7-2	Relief _duration [sec]	Determines the duration of the pressure relief phase that is entered by opening the flushing solenoid after the vane pump was halted.
	7-3	Load _switchover_ hysteresis [%]	Hysteresis of the load switching points in order to avoid the frequent load switching when the demand varies only in a narrow band around a switching point.
	7-4	Load_switch _wait [sec]	Switching from one load to an other is accomplished with a delay in order to avoid possible instabilities of the control process (oscillation). Par. „7-4“ allows for adjusting the delay.
	7-5	Delay _reverse osmosis system [sec]	For trouble-free operation of the system, a delay may be required between the opening of the water inlet solenoid and the start of the vane pump that awaits the pressure built-up in a remote osmosis device upstream of the nozzle system. The delay (in secs) may be determined by the setting of par „7-5“.
	7-6	Flush _manual	Flushing may be started and stopped manually by setting par „7-6“ to „1“ or „0“, respectively.
Modbus set- tings from software version 16114	9-1	Address	Setting Modbus RTU address
	9-2	Baud rate	Setting Baud rate
	9-3	Parity	Setting Parity (none, odd, even)
	9-4	Stopbits	Setting stopbits (one / two)

13. Maintenance

The nozzle system is maintenance-friendly. However, operational faults which can be traced back to inadequate or improper maintenance may occur.

Regular maintenance of the HygroMatik nozzle system LPS is indispensable for ensuring long service life

⚠ WARNING

Risk of electrical Shock!

Hazardous electrical voltage!

Unit must be switched off and protected against restart by expert staff (electricians or expert personnel with equivalent training) before any maintenance work is commenced.

13.1 Maintenance activities

For the system to operate without any problems the following checks and maintenance tasks must be carried out regularly:

1 x per month:

- » Check water tray and housing for contamination and clean if necessary.
- » Carry out a visual inspection of aerosol separators and clean if necessary.
- » Check the pump oil level.
- » Check the water filter cartridge upstream of the pump group for contamination and replace if necessary; flush the mains water system if necessary.
- » Check the resulting spray cone of the nozzles and clean nozzles if necessary (also see section „Cleaning the nozzles“).

1 x per year (or after 2500 h):

- » Check the nozzles as part of annual maintenance and clean in an ultrasonic bath (also see section „Cleaning the nozzles“). Replace nozzles, if required.
- » high-pressure pump.
- » Replace water filter cartridge

- » Carry out a visual inspection of the spray system, the aerosol separators and the humidification chamber; clean if necessary.
- » Check the function of the switch-off devices (e.g. the max. hygostat).

13.1.1 Checking/replacing the mains water filter

The mains water filter must be checked monthly for contamination and replaced when necessary. Colouring of the originally white water filter indicates contamination.

Contamination results in an increased resistance to flow. This lowers the supply pressure to the pump. An excessively low supply pressure can lead to switch-off of the nozzle system (dry run protection).

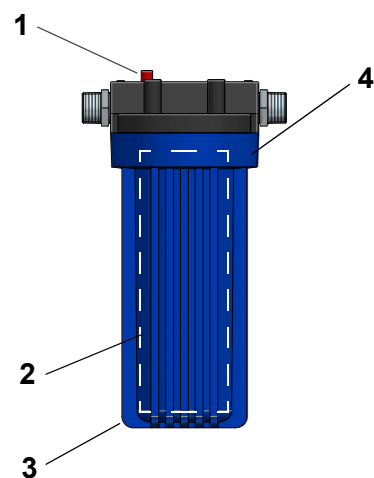

- (1) Venting button
- (2) Filter cartridge (inboard)
- (3) Filter housing
- (4) Holding of filter housing

Cleaning /replacement of the water filter

NOTICE

Risk of material damage.
Do not pinch the sealing ring.

- » Set the main switch on the control cabinet of the nozzle system to „0“.
- » Close the supply water stopcock upstream of the water filter.
- » Relieve the line pressure (press red button on the water filter top).
- » Open the filter housing by hand. The thread may be damaged if pliers are used.
- » Clean the filter housing.
- » Replace the filter cartridge (if necessary).
- » Screw the filter housing into the seat by hand.
- » Open the supply water stopcock.

13.1.2 Flushing the mains water system

- » Set the main switch on the control cabinet of the nozzle system to „0“.
- » Close the fresh water water stopcock upstream of the water filter.
- » Remove the water supply hose from the prefilter group.
- » Open the fresh water stopcock and flush the water line until the water appears to be free of contamination.
- » Close the fresh water stopcock.
- » Reconnect the water supply hose to the prefilter group.
- » Open the fresh water stopcock

13.1.3 Cleaning the nozzles

▲WARNING

Risk of injury due to high pressure remaining in the tubing.

Ensure that the high pressure is reduced by e.g. activating the flushing program.

- » Set the main switch on the control cabinet of the nozzle system to „0“.
- » Unscrew the nozzle (1) from the holder.
- » Screw the inner nozzle part out.
- » Remove nozzle insert (3)

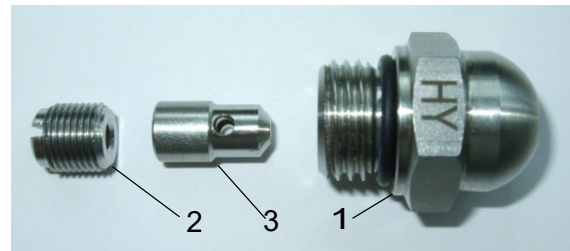

▲WARNING

Risk of eye injuries (acid burn)!

Wear proper PPE (Personal Protection Equipment = safety goggles) when cleaning the high-pressure nozzles!

- » Clean the nozzle components in an ultrasonic bath for about 10 minutes, if necessary use a lime remover in low concentration (less than 10%).
- » Put nozzle components back together.

13.1.4 Cleaning the aerosol separators

The aerosol separators should be checked every 4 weeks for possible contamination and cleaned if necessary. The aerosol separators should be thoroughly cleaned at least once a year.



- » Pull or lift the aerosol separators out of the guide rails.
- » Clean the aerosol separators with a cleaning agent and then rinse and dry them
- » Carry out a visual inspection of the aerosol separators, repeat the cleaning step if necessary and replace the aerosol separators if damaged.
- » Place the aerosol separators back on the guide rails. While doing so ensure that the trap frame drain holes are facing downwards to guarantee free drainage.



The spray system should be checked for contamination and damage every 4 weeks. Any contaminants must be removed with an alkaline-based cleaning agent basis that meets the VDI 6022 requirements. The spray system should be thoroughly cleaned at least once a year.

13.1.6 Cleaning the mounting profiles

The mounting profiles of the spray system and the aerosol separators should be reviewed as a part of the annual maintenance for contamination or damage. Possible impurities must be removed with a cleaning agent.

13.1.7 Cleaning the humidification chamber

Clean the humidification chamber and the base tray as required with the cleaning agent that is recommended by the manufacturer of the humidification chamber. After cleaning, rinse and let dry.

NOTICE

Risk of material damage!

When cleaning the spray system, do not aim the water jet at the aerosol separators. Any upstream or downstream heating or cooling units must not become wet during cleaning.





14. Trouble shooting





14.1 Error handling



On occurrence of a fault, humidification/cooling is stopped. The control panel display is switched to error code output. In the same instance, the general fault icon  starts flashing.



In case of some faults, additional icons flash that indicate the type of fault that has occurred.

14.1.1 Table of possible faults and related error codes

Icons	Code	Fault message	Possible cause	Counter measure
	000	No error		
	002	Expansion board	<ul style="list-style-type: none"> • P.c.b. connection not o.k. • P.c.b. not present or defective • CAN bus addressing not correct 	<ul style="list-style-type: none"> • Check firm connection of boards • Connect board, replace board if defective • Check DIP switch settings on extension board (see fig. in section 10.4).
 	022	Input_current_min The min. value of the input signal is no plausible	<ul style="list-style-type: none"> • Sensor, wiring or signal source defective • Input stage defective 	<ul style="list-style-type: none"> • Check sensor, wiring and signal source, if relevant • Replace mainboard
 	024 025 *)	Input_resistance_OC Input_resistance_SC The resistance measured is not correct („infinite“ or „zero“, resp.)	<ul style="list-style-type: none"> • Sensor, input wiring or signal source not correct • Input stage defective 	<ul style="list-style-type: none"> • Check sensor, signal cable and signal source, if applicable • Replace main PCB
*) When a PI-controller is in use, errors 022-025 relate to the sensor output signals. With an external controller the controller output signal is concerned.				

Icons	Code	Fault message	Possible cause	Counter measure
	029	Internal System failure	<ul style="list-style-type: none"> • Mainboard is defective 	<ul style="list-style-type: none"> • Replace mainboard
	150	Pressure sensor The pressure sensor delivers values outside the normal range	<ul style="list-style-type: none"> • Pressure sensor cable not connected • Pressure sensor defective • Broken wiring 	<ul style="list-style-type: none"> • Check cable connection and make correction, if required • Replace pressure sensor • Check wiring and fix, if required
	151	Max. pressure The feed pressure of the pressurised water has exceeded 15 bar for a period of 90 secs	<ul style="list-style-type: none"> • Nozzles clogged • Pressure relief valve not properly set 	<ul style="list-style-type: none"> • Clean or replace nozzles • Please contact HygroMatik GmbH
	152	Min. pressure Pressure cannot be built up within 90 seconds after actuation of the vane pump	<ul style="list-style-type: none"> • Pressure hose leaky • Pressure variations in RO device 	<ul style="list-style-type: none"> • Check pressure hose and replace, if required • Check RO device
 <p>applies to software version 1.1.3 and higher (from delivery 02.2022)</p>	153	Water inlet pressure Water inlet pressure is below 1 bar	<ul style="list-style-type: none"> • Water supply not yet connected • Water filter polluted • Pressure variations in RO device • Pressure switch defective 	<ul style="list-style-type: none"> • Connect water supply with pressure between 1 and 5 bar • Check filter and replace, if required • Check RO device • Replace pressure switch

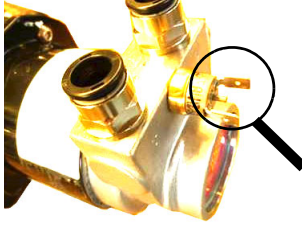
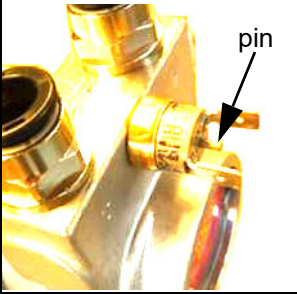
Icons	Code	Fault message	Possible cause	Counter measure
 <p>applies up to software version 1.1.3 and higher (until delivery 01.2022)</p>	153	Water inlet pressure Water inlet pressure is below 1 bar	<ul style="list-style-type: none"> • Water supply not yet connected • Water filter polluted • Pressure variations in RO device • Pressure switch defective • High pressure flush valve defective or dirty • Leakage at high pressure manifold • Pump wear • Leakage at nozzles, nozzle distributors or hoses • Bypass not set correctly • Overpressure protection not set correctly 	<ul style="list-style-type: none"> • Connect water supply with pressure between 1 and 5 bar • Check filter and replace, if required • Check RO device • Replace pressure switch • Clean or replace high-pressure flush valve • Seal high pressure manifold or replace defective component • Replace pump • Replace defective component • Adjust bypass (see data sheet) • Adjust overpressure protection (see data sheet)
	154	Pump leakage Water/oil has leaked from the pump and the float switch trips	<ul style="list-style-type: none"> • Pump is leaking • Float switch is stuck 	<ul style="list-style-type: none"> • Replace seals or pump, if required • Check float switch
	155	Frequency inverter The frequency inverter has produced an error message	<ul style="list-style-type: none"> • Motor overload • Short-circuit in motor wiring • Frequency inverter internal fault • Terminal short-circuit to ground 	<ul style="list-style-type: none"> • For fault elimination, please follow the instructions in the documentation of the frequency inverter
	156	Motor temperature Temperature control of the motor winding tripped because of excessive temperature	<ul style="list-style-type: none"> • Fan failed • Air inlets and outlets clogged 	<ul style="list-style-type: none"> • Check fan and replace, if necessary • Clean air inlets and outlet
	157	Cabinet temperature The thermal sensor in the cabinet measures a temperature $>50\text{ °C } \pm 10\%$	<ul style="list-style-type: none"> • Ventilation is obscured 	<ul style="list-style-type: none"> • Let unit cool down • Ensure unobscured ventilation

Icons	Code	Fault message	Possible cause	Counter measure
	158	Pump temperature Pump temperature exceeds 60°C.	<ul style="list-style-type: none"> • Nozzles or hoses blocked by e.g. debris • Ventilation of the housing not existent 	<ul style="list-style-type: none"> • Clean nozzles and/or pressure hoses • Check housing ventilation
				<ul style="list-style-type: none"> • Following any of the actions above, reset the thermo switch by pushing the pin in the position shown below: 
applies to software version 1.1.3 and higher (from delivery 02.2022)	159	Pressure_low Input pressure switch is activated. Pressure sensor measures a pressure < 0.9bar for at least 10 sec.	<ul style="list-style-type: none"> • High pressure flush valve defective or dirty • Leakage at high pressure manifold 	<ul style="list-style-type: none"> • Clean or replace high-pressure flush valve • Seal high pressure manifold or replace defective component
applies to software version 1.1.3 and higher (from delivery 02.2022)	160	FU_50Hz Pump pressure is below 25 bar at 50 Hz for at least 3 sec	<ul style="list-style-type: none"> • Pump wear • Leakage at nozzles, nozzle distributors or hoses • Bypass not set correctly • Overpressure protection not set correctly 	<ul style="list-style-type: none"> • Replace pump • Replace defective component • Adjust bypass (see data sheet) • Adjust overpressure protection (see data sheet)
 	210 211	R.h. sensor R.h. sensor 2 The value of a connected humidity sensor (option) is outside the normal range	<ul style="list-style-type: none"> • Humidity sensor defective • Line break 	<ul style="list-style-type: none"> • Replace humidity sensor • Replace line
	ErL	Error Link no communication between mainboard and display	<ul style="list-style-type: none"> • Mainboard or display unit defective 	<ul style="list-style-type: none"> • Replace mainboard or display unit

15. Declaration of conformity

EG-Konformitätserklärung EC Declaration of Conformity

Hersteller / Manufacturer: HygroMatik GmbH
Anschrift / Address: Lise-Meitner-Straße 3, D-24558 Henstedt-Ulzburg, Germany
Produktbezeichnung / Product description:
Low Pressure System: LPS45, LPS72, LPS110
In den Ausführungen / Type: Vollast, Voll- und Teillast, 3-Stufigkeit
full load, full and partial load, 3-step control

Die bezeichneten Produkte stimmen in der von uns in Verkehr gebrachten Ausführung mit den Vorschriften folgender Europäischer Richtlinien überein:

The products described above in the form as delivered are in conformity with the provisions of the following European Directives:

- | | |
|-------------------|---|
| 2014/30/EU | Richtlinie des Rates zur Angleichung der Rechtsvorschriften der Mitgliedstaaten über die elektromagnetische Verträglichkeit.
<i>Council Directive on the approximation of the laws of the Member States relating to electromagnetic compatibility.</i> |
| 2014/35/EU | Richtlinie des Rates zur Angleichung der Rechtsvorschriften der Mitgliedstaaten betreffend elektrische Betriebsmittel zur Verwendung innerhalb bestimmter Spannungsgrenzen.
<i>Council Directive on the approximation of the laws of the Member States related to electrical equipment designed for use within certain voltage limits.</i> |

Die Konformität mit den Richtlinien wird nachgewiesen durch die Einhaltung folgender Normen:
Conformity to the Directives is assured through the application of the following standards:

Referenznummer:	Ausgabedatum:	Referenznummer:	Ausgabedatum:
<i>Reference Number:</i>	<i>Edition:</i>	<i>Reference Number:</i>	<i>Edition:</i>
DIN EN 61000-6-2	2006-03	DIN EN 60335-1	2012-10
DIN EN 61000-6-3	2011-09	DIN EN 60335-1 Ber.1	2014-04
DIN EN 62233	2008-11	DIN EN 60335-2-98	2020-05
DIN EN 62233 Ber.1	2009-04	VDI 6022-1	2018-01
		VDI 3803-1	2010-02

Das Produkt entspricht den Anforderungen des deutschen Produktsicherheitsgesetzes ProdSG hinsichtlich der Gewährleistung von Sicherheit und Gesundheit. Produktänderungen nach Auslieferung können zum Verlust der Konformität führen.

The requirements of the German Product Safety Law ProdSG regarding the ensurance of safety and health are met. Product modifications after delivery may result in a loss of conformity.

Henstedt-Ulzburg, den / the 07.07.2021

HygroMatik GmbH



Dirc Menssing
Geschäftsführer / General Manager



Frank Michaelsen
Technischer Leiter / Head of Engineering

Diese Erklärung bescheinigt die Übereinstimmung mit den genannten Richtlinien, ist jedoch keine Zusicherung von Eigenschaften. Die Sicherheitshinweise der mitgelieferten Produktdokumentation sind zu beachten.

This declaration certifies the conformity to the specified directives but contains no assurance of properties. The safety documentation accompanying the product shall be considered in detail.

16. Spare parts

Article. No.	Description
Pump station	
PP-31-01041	Motor LPS Systems, 230 VAC, 0.37 kW
PP-33-01002	Thermal circuit breaker NC with automatic reset, switching point at 65°C ± 5K
PP-31-01032	Rotary vane pump LPS100, LPS110
PP-31-01022	Rotary vane pump LPS72
PP-31-01012	Rotary vane pump LPS45
E-7800478	Pipe fitting G 3/8 ", 10 mm hose connection
E-7600070	Reduction connector 10/8 x 6/4
E-7800422	Hose PA, black, 10 x 8
E-7800480	Plug-in L-shape connector 10 mm
E-7800484	Plug-in reduction connector 8/4 mm
E-7800486	Angle connector 4 mm
Water inlet	
WF-31-01001	Solenoid valve water feed LPS incl. Connectors
E-7704850	Pressure switch for water inlet
E-7601606	Screw /plug-in connector, angled, G 1/8 " internal thread/ 4 x 2
B-7621029	Water filter maintenance set
E-7705200	Water filter housing 10 ", 3/4 " internal thread connection on both sides
E-7800426	Hose PA, 4 x 2 mm
Water drain	
E-7800302	Solenoid valve LPS water drain 230 VAC/50-60 Hz
E-7800488	Through connector type G 4 - F.F, 6 mm plug-in connection on both sides
E-7800490	Connector type MO-F.C.C.C., 1 x plug-in connection 6 mm, 3 x plug-in sleeve 6 mm
E-7800492	Connector type MO-F.C.C.C., 1 x plug-in connection 6 mm, 4 x plug-in sleeve 6 mm
E-7800494	T-piece connector type T-F.F.C, 2 x plug-in connection 6 mm, 1 x plug-in sleeve 6 mm
E-7800496	T-piece connector type T-C.F.C, 1 x plug-in connection 6 mm, 2 x plug-in sleeve 6 mm
E-7800498	T-piece connector type T-F.C.C, 1 x plug-in connection 6 mm, 2 x plug-in sleeve 6 mm
E-7800482	Bulkhead fitting M 13 x 1
E-7600088	Angle plug-in connector 6 mm
E-7800428	Hose PA, 6 x 4 mm
E-7800614	High-pressure sensor 25 bar
E-7800444	Female pipe fitting G 1/8 ", 6 mm hose connection

Spare parts continued

Article. No.	Description
Electrical main assembly	
E-2504050	Auxiliary relay 230 VAC
E-2504046	12 VDC Relay K21/22
E-7704168	Noise filter FMLB-41
E-2504039	Safety fuse 5 A, 5 x 20 mm fast blow
E-7704870	Thermal circuit breaker NC with automatic reset, switching point at 50 °C ± 5K
CN-31-01002	Frequency converter 0.55 kW
CN-07-00080	LPS mainboard
CN-07-00030	Main assembly expansion board
CN-07-00001	Display StandardLine
CN-07-00059	Main connector 16 A (AC1), coil voltage 230 VAC
Spray system	
E-7701000	Vortex module
E-7800400	LPS water distribution manifold with 16 connections
E-7601586	Double nipple G 1/8 " - G 1/8 "
E-7800410	Sealing plug M 5
E-7800412	Sealing plug G 1/8 "
E-7800414	Pipe fitting M 5, 4 mm hose
E-7800416	Pipe fitting G 1/8 ", 6 mm hose
E-7800472	Mounting clip for LPS water distribution manifold
E-7800452	Nozzle mounting bracket
E-7621020	O-ring for nozzle mounting bracket
B-7800311	Spraying nozzle HY 0.27/120 ° incl. O-ring
B-7800313	Spraying nozzle HY 0.27/60 ° incl. O-ring
E-7601572	O-ring, 10 x 1.5, 70 ° Shore
E-7800424	Pipe fitting male 1/8", 90°, turnable, 4mm hose
E-7800428	Hose PA 6 x 4 mm
E-7800426	Hose PA 4 x 2 mm
B-7800301	LPS duct inlet fitting

For ordering spare parts, a template can be found on the www.hygromatik.com website under the „Contact“ tab. Your spare parts order may as well be directed per e-mail to the HygroMatik main office using the address hy@hygromatik.de.

Please make sure to specify your unit model and serial number.

17. Dimensions

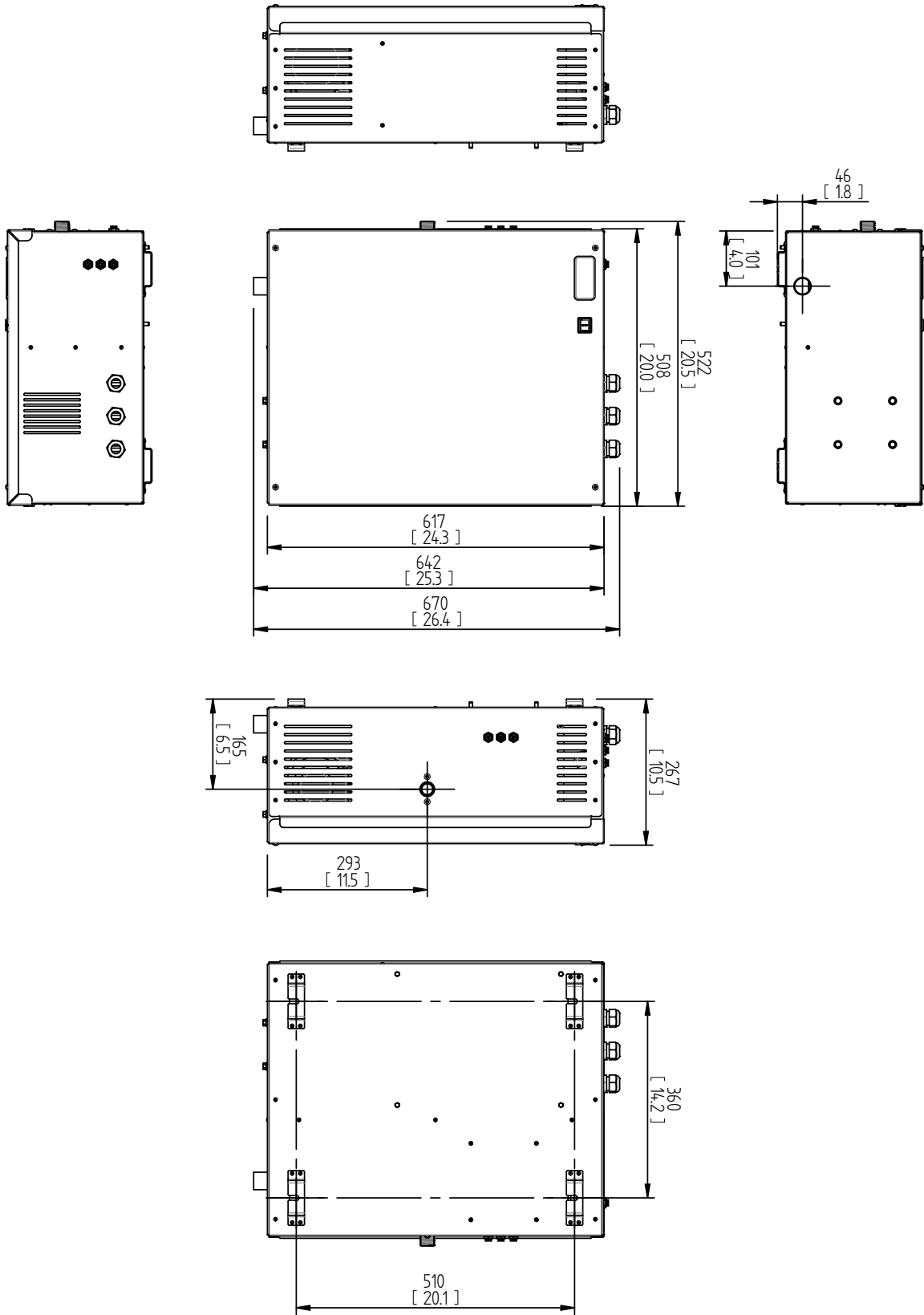

All measures in mm [inch]

18. Technical specifications

Model	Nozzle system LPS		
	LPS45	LPS72	LPS110
Effective output power [kg/h]	45	72	110
Electrical connection [V/Ph/Hz]	220 - 240/1/50 - 60		
Power rating [kW]	0,44	0,48	0,62
Nominal current [A]	1,8 - 2	2 - 2,2	2,5 - 2,9
Fuse [A]	1 x 16		
Control signal ¹⁾	0...10 V / 0...20 mA / 0...140 Ω		
Max. number of nozzles	15	22	32
Humidification section length, ideally [m]	0,9		
Total installation length, ideally [m]	1,5		
Air velocity [m/s]	0.9...2.8		
Pressure loss in duct [Pa]	80 @ 2.0 m/s		
Pump station height [mm]	670		
Pump station width [mm]	522		
Pump station depth [mm]	267		
water connection	external thread 3/4"		
Conductivity feed water	demineralised water / remaining conductivity 5-50 µS/cm		
Operating pressure feed water	1-4 bar		
Feed water temperature [°C]	5-15		
Weight pump station max. [kg]	30		

¹⁾ other control signals on request

HygroMATIK®

Lise-Meitner-Str.3 • D-24558 Henstedt-Ulzburg

Phone +49(0)4193/ 895-0 • Fax -33

eMail hy@hygromatik.de • www.hygromatik.com

member of **CAREL Group**

